

Model name:

MMY-MUP_1HT8P-E / E1

SMMSu
SUPER MODULAR MULTI SYSTEM

**Engineering
Data Book**







Outdoor units

Notice: Toshiba is committed to continuously improving its products to ensure the highest quality and reliability standards, and to meet local regulations and market requirements. All features and specifications are subject to change without prior notice.

	Safety caution.....	3
1	System overview	6
	1-1. Allocation standard of model name	6
	1-2. Summary of system equipments	7
2	Equipment selection procedure	13
	2-1. Selection flow chart.....	13
	2-2. Combination conditions for indoor unit and outdoor unit	14
	2-3. Cooling/heating capacity characteristics.....	14
	2-4. Operational temperature range.....	21
3	Refrigerant piping design.....	22
	3-1. Free branching system	22
	3-2. Allowable length/height difference of refrigerant piping	23
	3-3. Selection of refrigerant piping.....	25
	3-4. Charging requirement with additional refrigerant.....	27
4	Wiring design.....	30
	4-1. General	30
	4-2. Summary of wiring design	30
	4-3. Electrical wiring design	30
	4-4. Outdoor unit power supply.....	31
	4-5. Indoor unit power supply.....	32
	4-6. Design of control wiring	35
5	Outdoor unit.....	37
	5-1. Specifications.....	37
	5-2. Dimensional drawing	54
	5-3. Center of gravity	62
	5-4. Branch header / branch joint.....	63
	5-5. Refrigerant cycle diagram.....	66
	5-6. Wiring diagram.....	69
	5-7. Connecting diagram.....	72
	5-8. Applied control for Outdoor Unit	77
	5-9. Optional printed circuit board (PCB) of outdoor unit.....	81
	5-10 Part Load Performance	93
	5-11. Sound data (NC Curve)	150
	5-12. Sound data (NC Curve - Night operation mode)	160
6	PMV Kit.....	170
	6-1. Selection	170
	6-2. Wiring connections	171
	6-3. Dimensional drawing	172

- Before use, read carefully through the “Safety caution” section to ensure correct operation.
- The important contents concerned to the safety are described in the “Safety cautions”. Be sure to keep them. For Indications and their meanings, see the following description.

■ Warning Indications on the Air Conditioner Unit

Warning indication		Description
	<p>WARNING</p> <p>ELECTRICAL SHOCK HAZARD Disconnect all remote electric power supplies before servicing.</p>	<p>WARNING</p> <p>ELECTRICAL SHOCK HAZARD Disconnect all remote electric power supplies before servicing.</p>
	<p>WARNING</p> <p>Moving parts. Do not operate unit with grille removed. Stop the unit before the servicing.</p>	<p>WARNING</p> <p>Moving parts. Do not operate unit with grille removed. Stop the unit before the servicing.</p>
	<p>CAUTION</p> <p>High temperature parts. You might get burned when removing this panel.</p>	<p>CAUTION</p> <p>High temperature parts. You might get burned when removing this panel.</p>
	<p>CAUTION</p> <p>Do not touch the aluminum fins of the unit. Doing so may result in injury.</p>	<p>CAUTION</p> <p>Do not touch the aluminium fins of the unit. Doing so may result in injury.</p>
	<p>CAUTION</p> <p>BURST HAZARD Open the service valves before the operation, otherwise there might be the burst.</p>	<p>CAUTION</p> <p>BURST HAZARD Open the service valves before the operation, otherwise there might be the burst.</p>
	<p>CAUTION</p> <p>Do not climb onto the fan guard. Doing so may result in injury.</p>	<p>CAUTION</p> <p>Do not climb onto the fan guard. Doing so may result in injury.</p>

■ **Explanation of indications**

 **WARNING**

Indicates possibilities that a death or serious injury of personnel is caused by an incorrect handling.

 **CAUTION**

Indicates contents that an injury (*1) or property damage (*2) only may be caused when an incorrect work has been executed.

*1: "Injury" means a hurt, a burn, or an electric shock which does not require hospitalization or a long-term going to the hospital.

*2: "Property damage means an enlarged damage concerned to property, or breakage of materials.

- **After installation work has finished, check there is no trouble by a test operation, and explain using method and maintenance method to the customers based on the Owner's Manual.**

Please ask the customers to keep this Installation Manual together with the Owner's Manual.

 **WARNING**

Ask a shop or a professional dealer to install the air conditioner.

If you will install by yourself, a fire, an electric shock, or water leak is caused.

Take measures so that the refrigerant does not exceed the limit concentration even if it leaks when installing the air conditioner in a small room.

For the measures not to exceed the limit of concentration, contact the dealer. If the refrigerant leaks and it exceeds the limit of concentration, an accident of oxygen shortage is caused.

Install the air conditioner at a place which is satisfactorily bearable to weight.

If strength is insufficient, the unit may fall down resulting in human injury.

Perform a specified installation work against a strong wind such as typhoon or earthquake.

If the air conditioner is imperfectly installed, an accident by falling or dropping may be caused.

If refrigerant gas leaks during installation work, ventilate the room.

If the leaked refrigerant gas approaches to fire, noxious gas may generate.

After installation work, confirm that refrigerant gas does not leak.

If refrigerant gas leaks in the room, and approaches to fire such as fan heater, stove or kitchen range, generation of noxious gas may be caused.

Never recover refrigerant in the outdoor unit.

Be sure to use a refrigerant recovery device to recover refrigerant in reinstallation or repair work.

Recovery of refrigerant in the outdoor unit is unavailable; otherwise a serious accident such as crack or human injury is caused.

A person qualified for the electric work should deal with the electric construction conforming to the regulations of the local electric company and the Installation Manual. Be sure to use the exclusive circuit.

If there is capacity shortage of the power supply circuit or incomplete installation, a fire or an electric shock is caused.

For cabling, use the specified cables and connect them securely so that external force of cable does not transmit to the terminal connecting section.

If connection or fixing is incomplete, a fire, etc. may be caused.

Be sure to connect earth wire.

Do not connect earth wire to gas pipe, water pipe, lightning rod, nor earth wire of telephone.

If grounding is incomplete, an electric shock is caused.

 **CAUTION**

Do not install the air conditioner at a place where combustible gas may leak.

If gas leaks and is collected at surrounding the unit, the production of fire may be caused.

Be sure to attach an earth leakage breaker; otherwise an electric shock may be caused.

Using a torque wrench, tighten the flare nut in the specified method.

If the flare nut is exceedingly tightened, the flare nut is broken and a refrigerant leakage may be caused after a long time has passed.

WARNINGS ON REFRIGERANT LEAKAGE

Check of Concentration Limit

The room in which the air conditioner is to be installed requires a design that in the event of refrigerant gas leaking out, its concentration will not exceed a set limit.

The refrigerant R410A which is used in the air conditioner is safe, without the toxicity or combustibility of ammonia, and is not restricted by laws to be imposed which protect the ozone layer. However, since it contains more than air, it poses the risk of suffocation if its concentration should rise excessively.

Suffocation from leakage of R410A is almost nonexistent. With the recent increase in the number of high concentration buildings, however, the installation of multi air conditioner systems is on the increase because of the need for effective use of floor space, individual control, energy conservation by curtailing heat and carrying power etc.

Most importantly, the multi air conditioner system is able to replenish a large amount of refrigerant compared with conventional individual air conditioners. If a single unit of the multi conditioner system is to be installed in a small room, select a suitable model and installation procedure so that if the refrigerant accidentally leaks out, its concentration does not reach the limit (and in the event of an emergency, measures can be made before injury can occur).

In a room where the concentration may exceed the limit, create an opening with adjacent rooms, or install mechanical ventilation combined with a gas leak detection device.

The concentration is as given below.

$$\frac{\text{Total amount of refrigerant (kg)}}{\text{Min. volume of the indoor unit installed room (m}^3\text{)}} \leq \text{Concentration limit (kg/m}^3\text{)}$$

Concentration limit compliance to the local applicable regulations and standards for the concentration limit is required.

NOTE 1:

If there are 2 or more refrigerating systems in a single refrigerating device, the amounts of refrigerant should be as charged in each independent device.

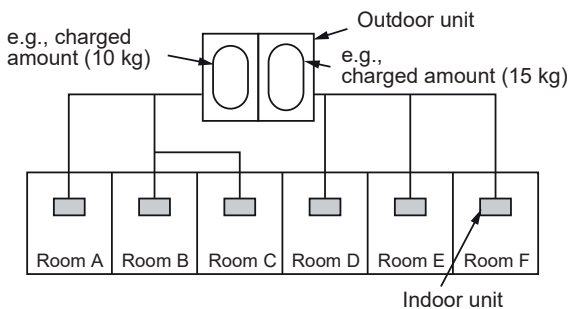

For the amount of charge in this example:

The possible amount of leaked refrigerant gas in rooms A, B and C is 10 kg.

The possible amount of leaked refrigerant gas in rooms D, E and F is 15 kg.

Important

NOTE 2:

The standards for minimum room volume are as follows.

- (1) No partition (shaded portion)

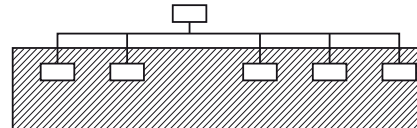

- (2) When there is an effective opening with the adjacent room for ventilation of leaking refrigerant gas (opening without a door, or an opening 0.15 % or larger than the respective floor spaces at the top or bottom of the door).

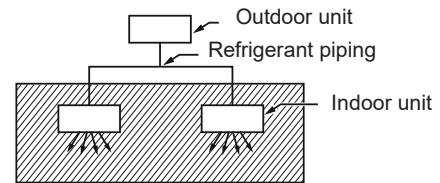

- (3) If an indoor unit is installed in each partitioned room and the refrigerant tubing is interconnected, the smallest room of course becomes the object. But when a mechanical ventilation is installed interlocked with a gas leakage detector in the smallest room where the density limit is exceeded, the volume of the next smallest room becomes the object.

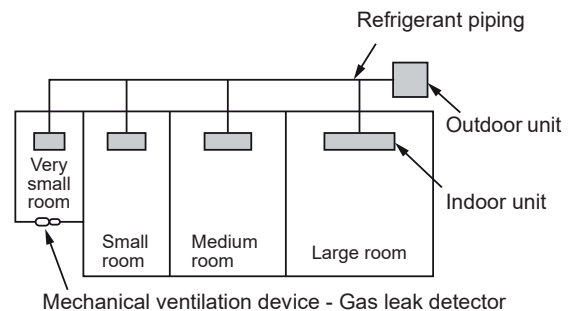

1-1. Allocation standard of model name SMMS-u

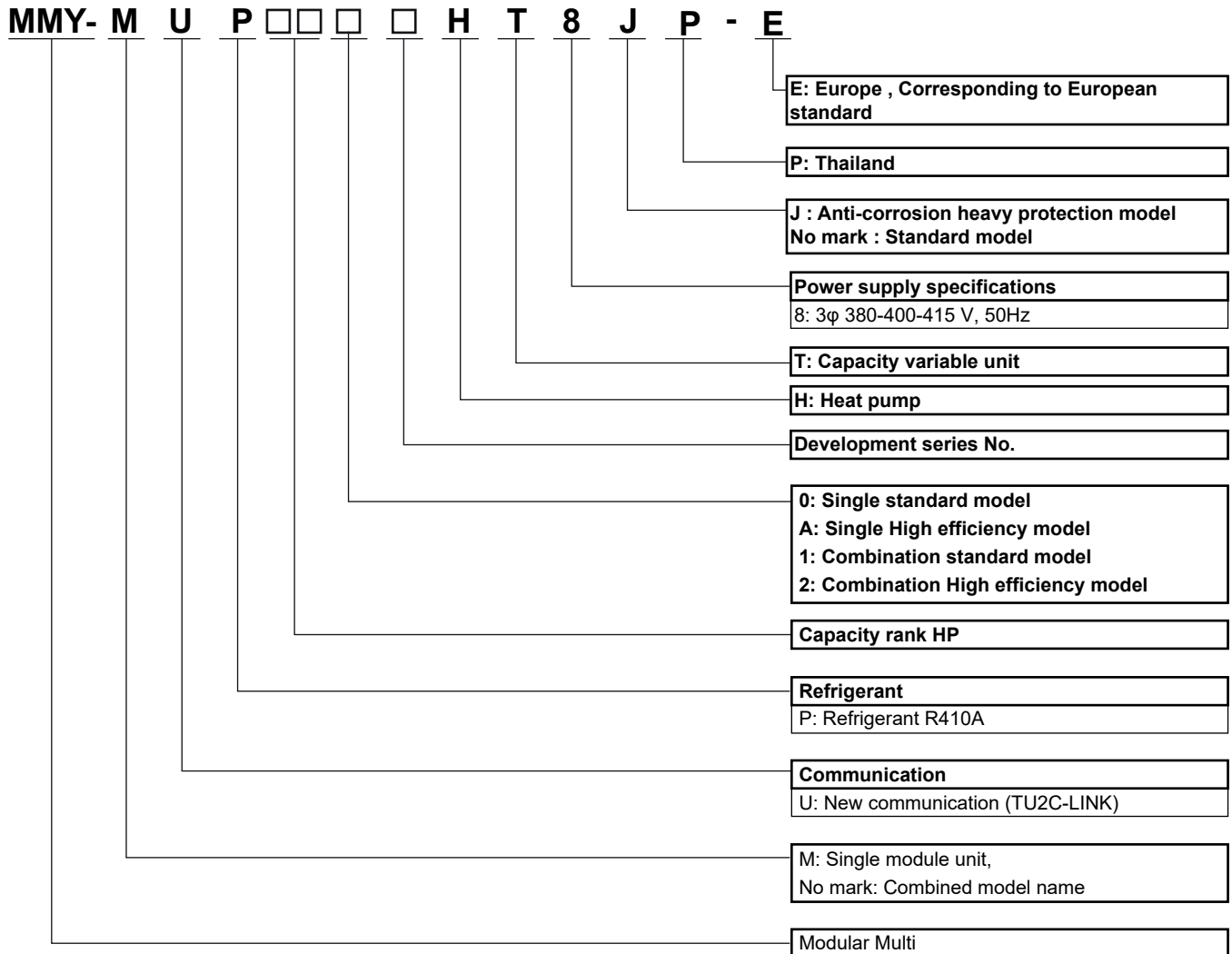

1-2. Summary of system equipments



1-2-1. Outdoor units

	Model name	Capacity rank (HP)	Cooling capacity (kW)	Heating		Combined outdoor units (MMY-)					No. of connectable indoor units
				Rated	Max	Unit 1	Unit 2	Unit 3	Unit 4	Unit 5	
Basic outdoor unit	MMY-MUP0801HT8P-E	8	22.4	22.4	25.0	8	—	—	—	—	18
	MMY-MUP1001HT8P-E	10	28.0	28.0	31.5	10	—	—	—	—	22
	MMY-MUP1201HT8P-E	12	33.5	33.5	37.5	12	—	—	—	—	27
	MMY-MUP1401HT8P-E	14	40.0	40.0	45.0	14	—	—	—	—	31
	MMY-MUP1601HT8P-E	16	45.0	45.0	50.0	16	—	—	—	—	36
	MMY-MUP1801HT8P-E	18	50.4	50.4	56.0	18	—	—	—	—	40
	MMY-MUP2001HT8P-E	20	56.0	56.0	63.0	20	—	—	—	—	45
	MMY-MUP2201HT8P-E	22	61.5	61.5	69.0	22	—	—	—	—	49
MMY-MUP2401HT8P-E1	24	67.0	61.5	70.0	24	—	—	—	—	54	
Combination of outdoor units	MMY-UP2611HT8P-E	26	73.5	73.5	82.5	14	12	—	—	—	58
	MMY-UP2811HT8P-E	28	80.0	80.0	90.0	14	14	—	—	—	63
	MMY-UP3011HT8P-E	30	83.9	83.9	93.5	18	12	—	—	—	64
	MMY-UP3211HT8P-E	32	89.5	89.5	100.5	20	12	—	—	—	65
	MMY-UP3411HT8P-E	34	96.0	96.0	108.0	20	14	—	—	—	66
	MMY-UP3611HT8P-E	36	100.5	95.0	107.5	24	12	—	—	—	67
	MMY-UP3811HT8P-E	38	107.0	101.5	115.0	24	14	—	—	—	68
	MMY-UP4011HT8P-E	40	112.0	112.0	126.0	20	20	—	—	—	69
	MMY-UP4211HT8P-E	42	117.4	111.9	126.0	24	18	—	—	—	70
	MMY-UP4411HT8P-E	44	123.0	117.5	133.0	24	20	—	—	—	71
	MMY-UP4611HT8P-E	46	128.5	123.0	139.0	24	22	—	—	—	72
	MMY-UP4811HT8P-E	48	134.0	123.0	140.0	24	24	—	—	—	73
	MMY-UP5011HT8P-E	50	140.5	135.0	152.5	24	14	12	—	—	74
	MMY-UP5211HT8P-E	52	147.0	141.5	160.0	24	14	14	—	—	75
	MMY-UP5411HT8P-E	54	152.0	152.0	171.0	20	20	14	—	—	76
	MMY-UP5611HT8P-E	56	156.5	151.0	170.5	24	20	12	—	—	77
	MMY-UP5811HT8P-E	58	163.0	157.5	178.0	24	20	14	—	—	78
	MMY-UP6011HT8P-E	60	167.5	156.5	177.5	24	24	12	—	—	79
	MMY-UP6211HT8P-E	62	174.0	163.0	185.0	24	24	14	—	—	80
	MMY-UP6411HT8P-E	64	179.0	173.5	196.0	24	20	20	—	—	81
	MMY-UP6611HT8P-E	66	184.5	179.0	202.0	24	22	20	—	—	82
	MMY-UP6811HT8P-E	68	190.0	179.0	203.0	24	24	20	—	—	83
	MMY-UP7011HT8P-E	70	195.5	184.5	209.0	24	24	22	—	—	84
	MMY-UP7211HT8P-E	72	201.0	184.5	210.0	24	24	24	—	—	85
	MMY-UP7411HT8P-E	74	207.5	196.5	222.5	24	24	14	12	—	86
	MMY-UP7611HT8P-E	76	214.0	203.0	230.0	24	24	14	14	—	87
	MMY-UP7811HT8P-E	78	219.0	213.5	241.0	24	20	20	14	—	88
	MMY-UP8011HT8P-E	80	223.5	212.5	240.5	24	24	20	12	—	90
	MMY-UP8211HT8P-E	82	230.0	219.0	248.0	24	24	20	14	—	92
	MMY-UP8411HT8P-E	84	234.5	218.0	247.5	24	24	24	12	—	94
	MMY-UP8611HT8P-E	86	241.0	224.5	255.0	24	24	24	14	—	96
	MMY-UP8811HT8P-E	88	246.0	235.0	266.0	24	24	20	20	—	98
MMY-UP9011HT8P-E	90	251.5	240.5	272.0	24	24	22	20	—	100	
MMY-UP9211HT8P-E	92	257.0	240.5	273.0	24	24	24	20	—	102	
MMY-UP9411HT8P-E	94	262.5	246.0	279.0	24	24	24	22	—	104	
MMY-UP9611HT8P-E	96	268.0	246.0	280.0	24	24	24	24	—	106	
MMY-UP9811HT8P-E	98	274.5	258.0	292.5	24	24	24	14	12	108	
MMY-UP10011HT8P-E	100	281.0	264.5	300.0	24	24	24	14	14	110	
MMY-UP10211HT8P-E	102	286.0	275.0	311.0	24	24	20	20	14	112	
MMY-UP10411HT8P-E	104	290.5	274.0	310.5	24	24	24	20	12	114	
MMY-UP10611HT8P-E	106	297.0	280.5	318.0	24	24	24	20	14	116	
MMY-UP10811HT8P-E	108	301.5	279.5	317.5	24	24	24	24	12	118	
MMY-UP11011HT8P-E	110	308.0	286.0	325.0	24	24	24	24	14	120	
MMY-UP11211HT8P-E	112	313.0	296.5	336.0	24	24	24	20	20	122	
MMY-UP11411HT8P-E	114	318.5	302.0	342.0	24	24	24	22	20	124	
MMY-UP11611HT8P-E	116	324.0	302.0	343.0	24	24	24	24	20	126	
MMY-UP11811HT8P-E	118	329.5	307.5	349.0	24	24	24	24	22	128	
MMY-UP12011HT8P-E	120	335.0	307.5	350.0	24	24	24	24	24	128	

1-2-2. Indoor unit

Type	Appearance	Model name	Capacity rank	Capacity code	Cooling capacity (kW)	Heating capacity (kW)	PMV Kit
Smart 4-Way Air Discharge Cassette Type		MMU-UP0091H-E	009 type	1.00	2.8	3.2	Available
		MMU-UP0121H-E	012 type	1.25	3.6	4.0	Available
		MMU-UP0151H-E	015 type	1.70	4.5	5.0	Available
		MMU-UP0181H-E	018 type	2.00	5.6	6.3	Available
		MMU-UP0241H-E	024 type	2.50	7.1	8.0	Available
		MMU-UP0271H-E	027 type	3.00	8.0	9.0	Available
		MMU-UP0301H-E	030 type	3.20	9.0	10.0	Available
		MMU-UP0361H-E	036 type	4.00	11.2	12.5	-
4-Way Air Discharge Cassette Type		MMU-UP0091HP-E	009 type	1.00	2.8	3.2	Available
		MMU-UP0121HP-E	012 type	1.25	3.6	4.0	Available
		MMU-UP0151HP-E	015 type	1.70	4.5	5.0	Available
		MMU-UP0181HP-E	018 type	2.00	5.6	6.3	Available
		MMU-UP0241HP-E	024 type	2.50	7.1	8.0	Available
		MMU-UP0271HP-E	027 type	3.00	8.0	9.0	Available
		MMU-UP0301HP-E	030 type	3.20	9.0	10.0	Available
		MMU-UP0361HP-E	036 type	4.00	11.2	12.5	-
Compact 4-way Cassette Type		MMU-UP0051MH-E	005 type	0.60	1.7	1.9	Available
		MMU-UP0071MH-E	007 type	0.80	2.2	2.5	Available
		MMU-UP0091MH-E	009 type	1.00	2.8	3.2	Available
		MMU-UP0121MH-E	012 type	1.25	3.6	4.0	Available
		MMU-UP0151MH-E	015 type	1.70	4.5	5.0	Available
2-Way Air Discharge Cassette Type		MMU-UP0181MH-E	018 type	2.00	5.6	6.3	Available
		MMU-UP0071WH-E	007 type	0.80	2.2	2.5	Available
		MMU-UP0091WH-E	009 type	1.00	2.8	3.2	Available
		MMU-UP0121WH-E	012 type	1.25	3.6	4.0	Available
		MMU-UP0151WH-E	015 type	1.70	4.5	5.0	Available
		MMU-UP0181WH-E	018 type	2.00	5.6	6.3	Available
		MMU-UP0241WH-E	024 type	2.50	7.1	8.0	Available
		MMU-UP0271WH-E	027 type	3.00	8.0	9.0	Available
		MMU-UP0301WH-E	030 type	3.20	9.0	10.0	Available
		MMU-UP0361WH-E	036 type	4.00	11.2	12.5	-
1-Way Air Discharge Cassette Type		MMU-UP0481WH-E	048 type	5.00	14.0	16.0	-
		MMU-UP0561WH-E	056 type	6.00	16.0	18.0	-
		MMU-UP0031YHP-E	003 type	0.30	0.9	1.3	Available
		MMU-UP0051YHP-E	005 type	0.60	1.7	1.9	Available
		MMU-UP0071YHP-E	007 type	0.80	2.2	2.5	Available
		MMU-UP0091YHP-E	009 type	1.00	2.8	3.2	Available
		MMU-UP0121YHP-E	012 type	1.25	3.6	4.0	Available
		MMU-UP0151YHP-E	015 type	1.70	4.5	5.0	Available
		MMU-UP0181YHP-E	018 type	2.00	5.6	6.3	Available
		MMU-UP0241YHP-E	024 type	2.50	7.1	8.0	Available
		MMU-UP0271YHP-E	027 type	3.00	8.0	9.0	Available
		MMU-UP0151SH-E	015 type	1.70	4.5	5.0	Available
		MMU-UP0181SH-E	018 type	2.00	5.6	6.3	Available
Concealed Duct Type		MMU-UP0241SH-E	024 type	2.50	7.1	8.0	Available
		MMD-UP0051BHP-E	005 type	0.60	1.7	1.9	Available
		MMD-UP0071BHP-E	007 type	0.80	2.2	2.5	Available
		MMD-UP0091BHP-E	009 type	1.00	2.8	3.2	Available
		MMD-UP0121BHP-E	012 type	1.25	3.6	4.0	Available
		MMD-UP0151BHP-E	015 type	1.70	4.5	5.0	Available
		MMD-UP0181BHP-E	018 type	2.00	5.6	6.3	Available
		MMD-UP0241BHP-E	024 type	2.50	7.1	8.0	Available
		MMD-UP0271BHP-E	027 type	3.00	8.0	9.0	Available
		MMD-UP0301BHP-E	030 type	3.20	9.0	10.0	Available
		MMD-UP0361BHP-E	036 type	4.00	11.2	12.5	-
		MMD-UP0481BHP-E	048 type	5.00	14.0	16.0	-
MMD-UP0561BHP-E	056 type	6.00	16.0	18.0	-		

Type	Appearance	Model name	Capacity rank	Capacity code	Cooling capacity (kW)	Heating capacity (kW)	PMV Kit
Slim Duct Type		MMD-UP0031SPHY-E	003 type	0.30	0.9	1.0	Available
		MMD-UP0051SPHY-E	005 type	0.60	1.7	1.9	Available
		MMD-UP0071SPHY-E	007 type	0.80	2.2	2.5	Available
		MMD-UP0091SPHY-E	009 type	0.90	2.5	2.8	Available
		MMD-UP0121SPHY-E	012 type	1.00	2.8	3.2	Available
		MMD-UP0151SPHY-E	015 type	1.10	3.2	3.6	Available
		MMD-UP0181SPHY-E	018 type	1.25	3.6	4.0	Available
		MMD-UP0241SPHY-E	024 type	1.50	4.0	4.5	Available
Concealed Duct High Static Pressure Type		MMD-UP0181HP-E	018 type	2.00	5.6	6.3	Available
		MMD-UP0241HP-E	024 type	2.50	7.1	8.0	Available
		MMD-UP0271HP-E	027 type	3.00	8.0	9.0	Available
		MMD-UP0361HP-E	036 type	4.00	11.2	12.5	-
		MMD-UP0481HP-E	048 type	5.00	14.0	16.0	-
		MMD-UP0561HP-E	056 type	6.00	16.0	18.0	-
		MMD-UP0721HP-E1	072 type	8.00	22.4	25.0	-
		MMD-UP0961HP-E1	096 type	10.00	28.0	31.5	-
Ceiling Type		MMC-UP0151HP-E	015 type	1.70	4.5	5.0	Available
		MMC-UP0181HP-E	018 type	2.00	5.6	6.3	Available
		MMC-UP0241HP-E	024 type	2.50	7.1	8.0	Available
		MMC-UP0271HP-E	027 type	3.00	8.0	9.0	Available
		MMC-UP0361HP-E	036 type	4.00	11.2	12.5	-
		MMC-UP0481HP-E	048 type	5.00	14.0	16.0	-
		MMC-UP0561HP-E	056 type	6.00	16.0	18.0	-
High Wall Type		MMK-UP0031HP-E	003 type	0.30	0.9	1.0	Available
		MMK-UP0051HP-E	005 type	0.60	1.7	1.9	Available
		MMK-UP0071HP-E	007 type	0.80	2.2	2.5	Available
		MMK-UP0091HP-E	009 type	1.00	2.8	3.2	Available
		MMK-UP0121HP-E	012 type	1.25	3.6	4.0	Available
		MMK-UP0151HP-E	015 type	1.70	4.5	5.0	Available
		MMK-UP0181HP-E	018 type	2.00	5.6	6.3	Available
		MMK-UP0241HP-E	024 type	2.50	7.1	8.0	Available
		MMK-UP0271HP-E	027 type	3.00	8.0	9.0	Available
		MMK-UP0301HP-E	030 type	3.20	9.0	10.0	Available
		MMK-UP0361HP-E	036 type	4.00	11.2	12.5	-
Floor Standing Concealed Type		MML-UP0071BH-E	007 type	0.80	2.2	2.5	Available
		MML-UP0091BH-E	009 type	1.00	2.8	3.2	Available
		MML-UP0121BH-E	012 type	1.25	3.6	4.0	Available
		MML-UP0151BH-E	015 type	1.70	4.5	5.0	Available
		MML-UP0181BH-E	018 type	2.00	5.6	6.3	Available
		MML-UP0241BH-E	024 type	2.50	7.1	8.0	Available
Floor Standing Cabinet Type		MML-UP0071H-E	007 type	0.80	2.2	2.5	Available
		MML-UP0091H-E	009 type	1.00	2.8	3.2	Available
		MML-UP0121H-E	012 type	1.25	3.6	4.0	Available
		MML-UP0151H-E	015 type	1.70	4.5	5.0	Available
		MML-UP0181H-E	018 type	2.00	5.6	6.3	Available
Floor Standing Type		MMF-UP0151H-E	015 type	1.70	4.5	5.0	Available
		MMF-UP0181H-E	018 type	2.00	5.6	6.3	Available
		MMF-UP0241H-E	024 type	2.50	7.1	8.0	Available
		MMF-UP0271H-E	027 type	3.00	8.0	9.0	Available
		MMF-UP0361H-E	036 type	4.00	11.2	12.5	-
		MMF-UP0481H-E	048 type	5.00	14.0	16.0	-
Console Type		MML-UP0071NHP-E	007 type	0.80	2.2	2.5	Available
		MML-UP0091NHP-E	009 type	1.00	2.8	3.2	Available
		MML-UP0121NHP-E	012 type	1.25	3.6	4.0	Available
		MML-UP0151NHP-E	015 type	1.70	4.5	5.0	Available
		MML-UP0181NHP-E	018 type	2.00	5.6	6.3	Available
Hot Water Module		MMW-UP0271LQ-E	027 type	2.50	-	8.0	-
		MMW-UP0561LQ-E	056 type	5.00	-	16.0	-
Fresh Air Intake Indoor unit Type		MMD-UP0481HFP-E	048 type	5.00	14.0	8.9	-
		MMD-UP0721HFP-E1	072 type	8.00	22.4	13.9	-
		MMD-UP0961HFP-E1	096 type	10.00	28.0	17.4	-
		MMD-UP1121HFP-E1	112 type	12.00	33.5	20.8	-
		MMD-UP1281HFP-E1	128 type	14.00	40.0	25.2	-

Type	Appearance	Model name	Capacity rank	Capacity code	Cooling capacity (kW)	Heating capacity (kW)	PMV Kit
Dx-coil Inerface		TCB-IFDTA201E	8~40	22.4~112.0	22.4~112.0	25.0~126.0	-
		TCB-IFDDC201E	8~20	22.4~56.0	22.4~56.0	25.0~63.0	-
		RBM-A101VAE	8,10	22.4~28.0	22.4~28.0	25.0~31.5	-
		RBM-A201VAE	16,18,20	45.0~56.0	45.0~56.0	50.0~63.0	-
		TCB-IFDMR01UP-E	8~40	22.4~112.0	22.4~112.0	25.0~126.0	-
		TCB-IFDMX01UP-E	8~40	22.4~112.0	22.4~112.0	25.0~126.0	-
		RBM-A101UPVA-E	8,10,12	22.4~33.5	22.4~33.5	25.0~37.5	-
		RBM-A201UPVA-E	14,16,18,20	40.0~56.0	40.0~56.0	45.0~63.0	-

(*1) Large Capacity Floor Standing Type can support only old communication protocol.

1-2-3. Branching joints and headers

Name	Appearance	Model name	Remarks
Y-shape branching joint		RBM-BY55E	
		RBM-BY105E	
		RBM-BY205E	
		RBM-BY305E	
		RBM-BY405E	
4-branching header		RBM-HY1043E	
		RBM-HY2043E	
8-branching header		RBM-HY1083E	
		RBM-HY2083E	
Branching joint for connection of outdoor units		RBM-BT14E	
		RBM-BT24E	
		RBM-BT34E	

1-2-4. PMV Kits

Name	Appearance	Model name	Remarks
PMV Kits		RBM-PMV0361U-E	
		RBM-PMV0901U-E	

1-2-5. Optional PCB of outdoor unit

Name	Appearance	Model name	Remarks
Power peak-cut control board		TCB-PCDM4E	
External master ON/OFF control board		TCB-PCMO4E	
Output control board		TCB-PCIN4E	

1-2-6. TU2C-LINK Remote controllers

Name	Model name	Remarks
Wired remote controller	RBC-AMSU**-ES	-EN : English, Italian, Polish, Greece, Russian, Turkish -ES : English, Spanish, Portuguese, French, Dutch, German
	RBC-AMSU**-EN	
	RBC-AMTU**-E	
Wireless remote controller kit	RBC-ASCU**-E	
	RBC-AXU**U-E	For 4-way Air Discharge Cassette (HP)
	RBC-AXU**UM-E	For Compact 4-way Cassette
	RBC-AXU**UW-E	For 2-way Air Discharge Cassette
	RBC-AXU**C-E	For Ceiling, 1-way Air Discharge Cassette (SH)
	RBC-AX33UYP-E	For 1-way Air Discharge Cassette(YHP 1.7-3.0HP)
	TCB-AXU31-E	For Other unit

1-2-7. TU2C-LINK Controls

Name	Model name	Remarks
Touch Screen Controller	BMS-CT2560U-E	
64 Central remote controller	TCB-SC640U-E	
Modbus Interface	BMS-IFMB640U-E	
BN Interface	BMS-IFBN640U-E	

1-2-8. Remote controllers

Name	Model Name	Remarks
Wired remote controller	RBC-AMT***	
	RBC-AMS**E-EN	-EN : English, Italian, Polish, Greece, Russian, Turkish -ES : English, Spanish, Portuguese, French, Dutch, German
	RBC-AMS**E-ES	
	NRC-01HE	For Air to Air Heat Exchanger with DX coil unit
Simple wired remote controller	RBC-AS41E	
Wireless remote controller kit	RBC-AX*3*U-E	For 4-way Air Discharge Cassette (HP)
	RBC-AX***UM-E	For Compact 4-way Cassette
	RBC-AX***UW*-E	For 2-way Air Discharge Cassette
	RBC-AX***C*	For Ceiling, 1-way Air Discharge Cassette (SH)
	RBC-AXU31-E	For Other unit
TCB-AX32E2		
Remote controller with schedule timer (7-day timer function)	RBC-AMS41E	

1-2-9. Controls

Name	Model name	Remarks
Touch Screen Controller	BMS-CT5121E	
Smart manager	BMS-SM1280HTLE	
Smart manager with data analyzer	BMS-SM1281ETLE	
64 Central remote controller	TCB-SC643TLE	
Schedule timer	TCB-EXS21TLE	
Relay Interface	BMS-IFLSV4E	
Energy Monitoring Relay Interface	BMS-IFWH5E	
Digital I/O Relay Interface	BMS-IFDD03E	
LonWorks LN Interface	TCB-IFLN642TLE	
Modbus Interface	TCB-IFMB641TLE	
Analog Interface	TCB-IFCB640TLE	
BN Interface	BMS-IFBN640TLE	

2-1. Selection flow chart

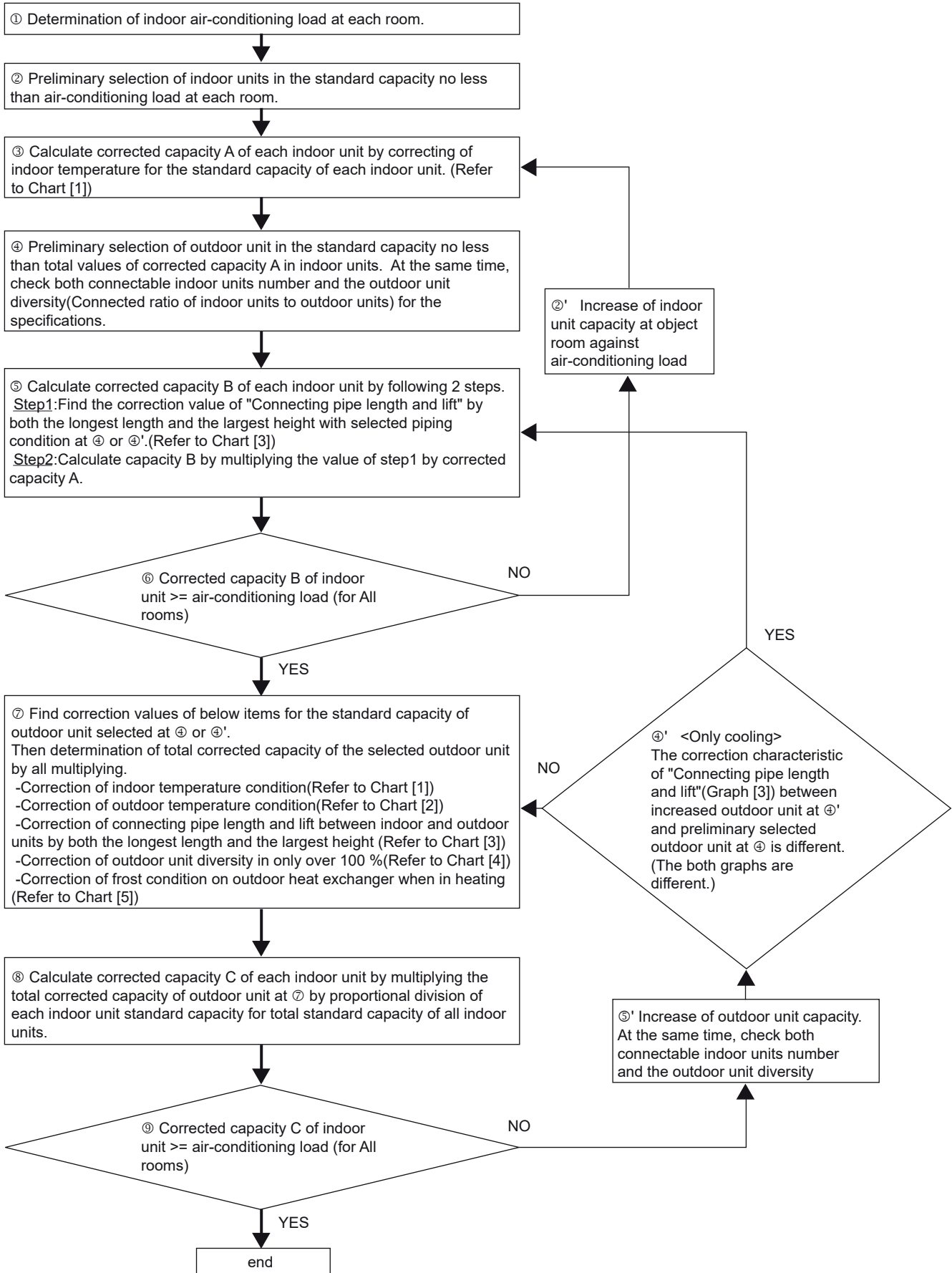

2-2. Combination conditions for indoor unit and outdoor unit

Indoor unit can connect 50% to 200% of Outdoor unit capacity.

NOTE:

- Height difference between indoor units is less than 15 m and single outdoor unit system, combination condition for indoor and outdoor unit is 50% to 200%
- Height difference between indoor unit is less than 15 m and multiple outdoor units system, combination condition for indoor and outdoor unit is 50% to 150%
- Height difference between indoor unit is more than 15 m, combination condition for indoor and outdoor unit is 50% to 105%
- If Smart 4-Way Air Discharge Cassette Type (MMU-UP * * * H-E) is include in the system, combination condition for indoor and outdoor unit is 50% to 105%

2-3. Cooling/heating capacity characteristics

2-3-1. Correction charts for cooling capacity calculation

[1] Indoor air wet bulb temperature vs. capacity correction value

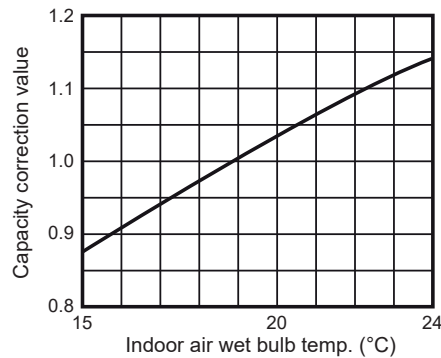

[2] Outdoor air dry bulb temperature vs. capacity correction value

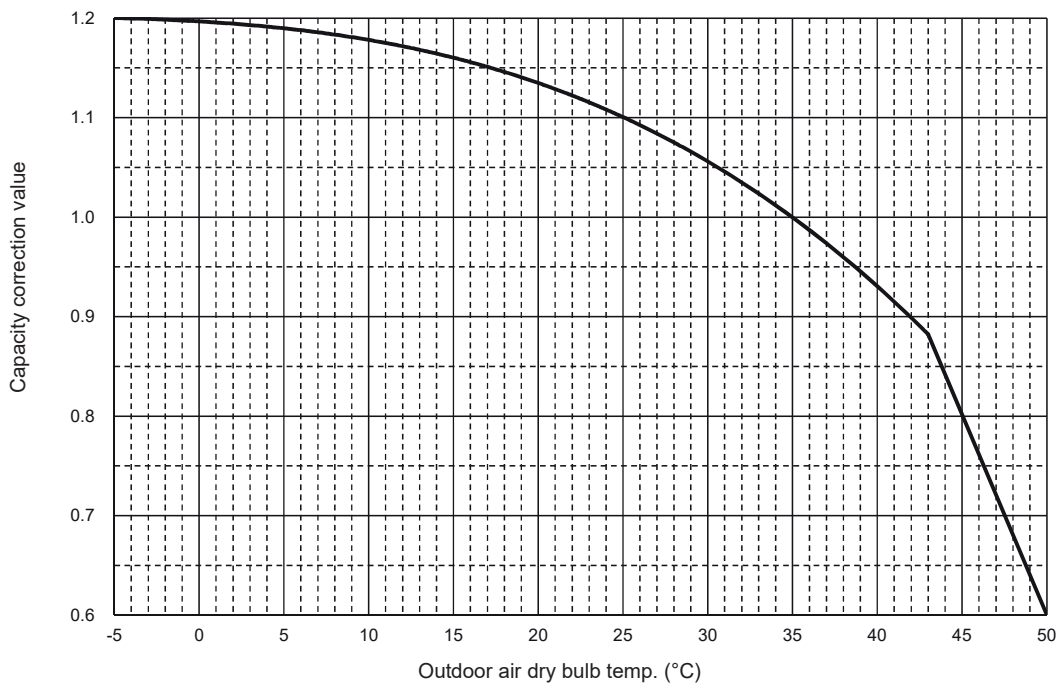

[3] Connecting pipe length and lift difference between indoor and outdoor units vs. capacity correction value

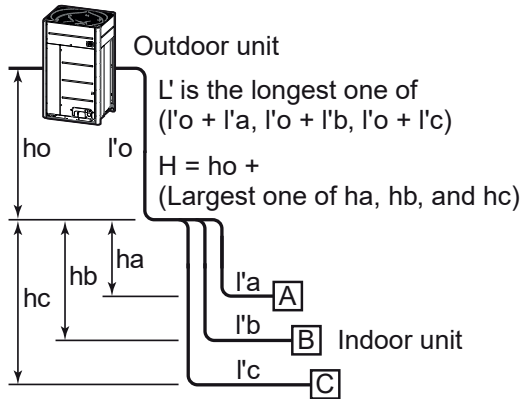

Capacity HP	Graph	Standard model	
		Combination HP	Pipe length [m]
8	D	8	210
10	C	10	210
12	A	12	210
14	A	14	210
16	B	16	210
18	C	18	210
20	C	20	210
22	C	22	210
24	A	24	210
26	B	14+ 12	220
28	B	14+ 14	220
30	B	18+ 12	220
32	C	20+ 12	220
34	C	20+ 14	220
36	A	24+ 12	220
38	A	24+ 14	220
40	B	20+ 20	220
42	B	24+ 18	220
44	B	24+ 20	220
46	B	24+ 22	220
48	C	24+ 24	220
50	C	24+ 14+ 12	250
52	C	24+ 14+ 14	250
54	E	20+ 20+ 14	200
56	E	24+ 20+ 12	200
58	E	24+ 20+ 14	200
60	E	24+ 24+ 12	200
62	E	24+ 24+ 14	200
64	E	24+ 20+ 20	200
66	E	24+ 22+ 20	200
68	E	24+ 24+ 20	200
70	E	24+ 24+ 22	200
72	E	24+ 24+ 24	200
74	E	24+ 24+ 14+ 12	200
76	E	24+ 24+ 14+ 14	200
78	E	24+ 20+ 20+ 14	200
80	E	24+ 24+ 14+ 14	200
82	E	24+ 24+ 20+ 14	200
84	E	24+ 24+ 24+ 12	200
86	E	24+ 24+ 24+ 14	200
88	E	24+ 24+ 20+ 20	200
90	E	24+ 24+ 22+ 20	200
92	E	24+ 24+ 24+ 20	200
94	E	24+ 24+ 24+ 22	200
96	E	24+ 24+ 24+ 24	200
98	E	24+ 24+ 24+ 14+ 12	200
100	E	24+ 24+ 24+ 14+ 14	200
102	E	24+ 24+ 20+ 20+ 14	200
104	E	24+ 24+ 24+ 20+ 12	200
106	E	24+ 24+ 24+ 20+ 14	200
108	E	24+ 24+ 24+ 24+ 12	200
110	E	24+ 24+ 24+ 24+ 14	200
112	E	24+ 24+ 24+ 20+ 20	200
114	E	24+ 24+ 24+ 22+ 20	200
116	E	24+ 24+ 24+ 24+ 20	200
118	E	24+ 24+ 24+ 24+ 22	200
120	E	24+ 24+ 24+ 24+ 24	200

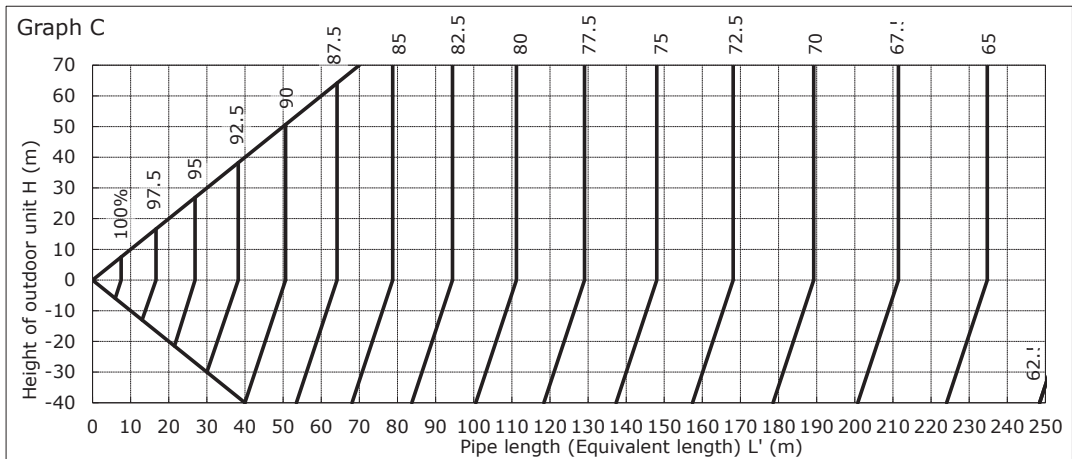
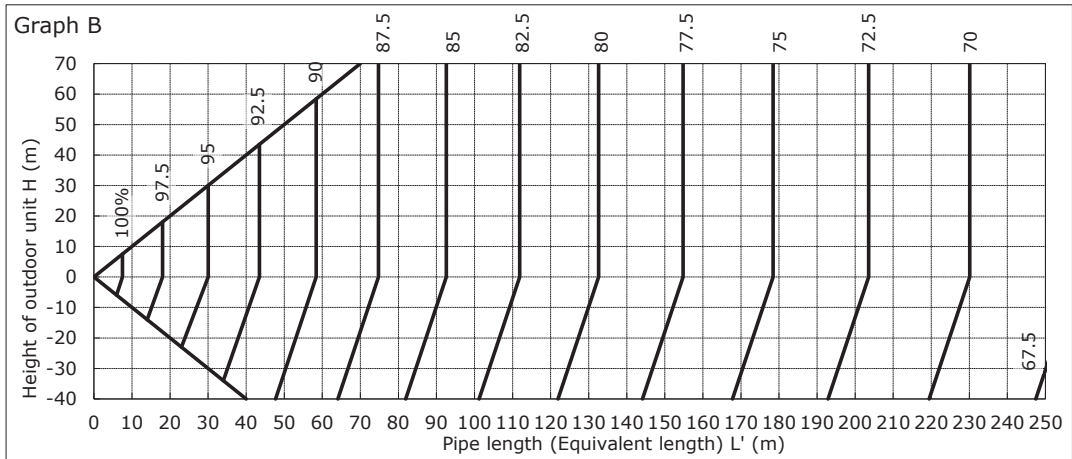
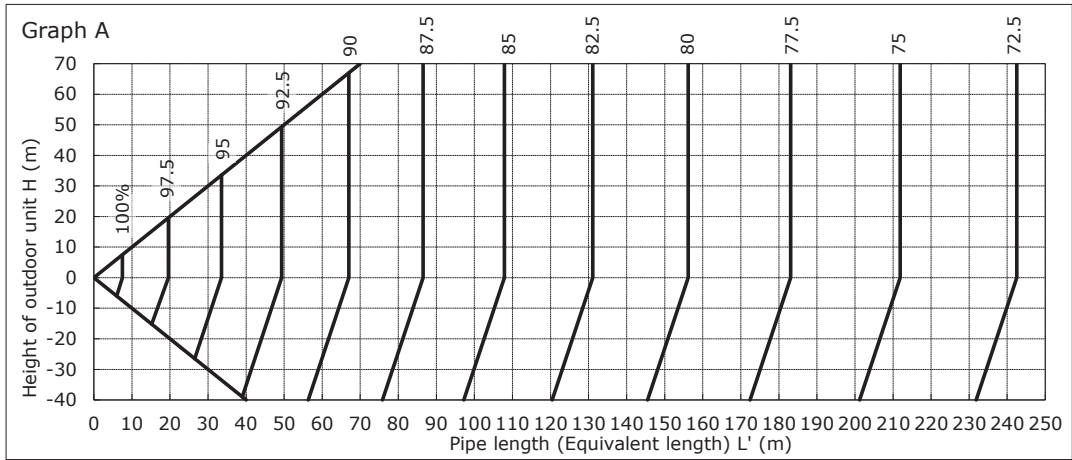

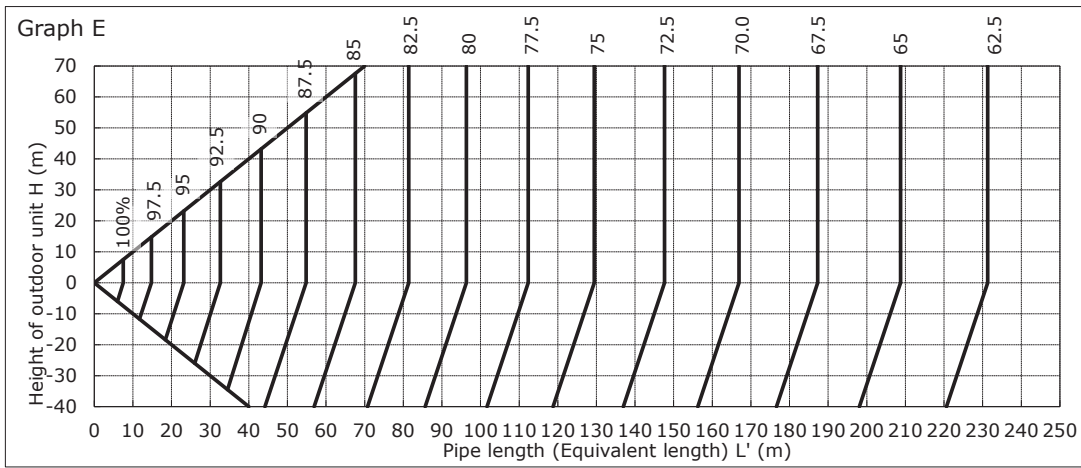
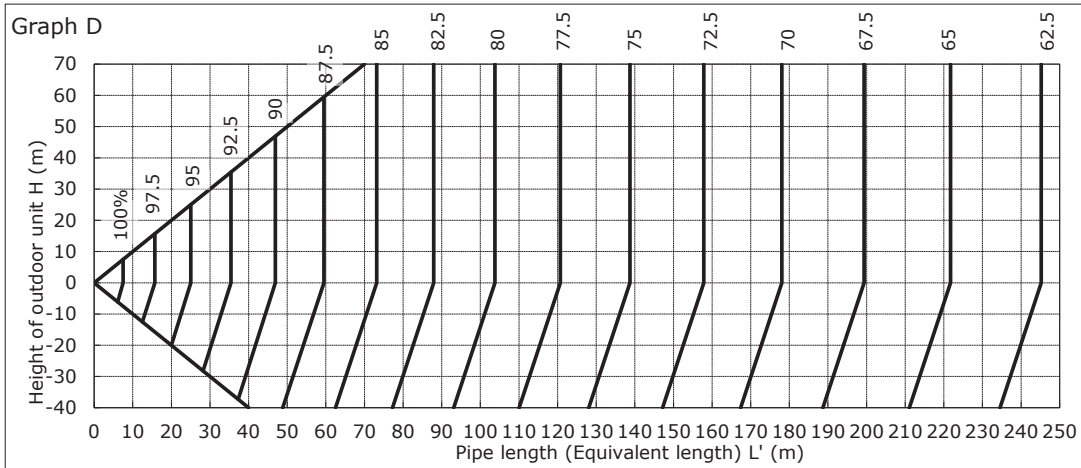

[4]* Correction of outdoor unit diversity

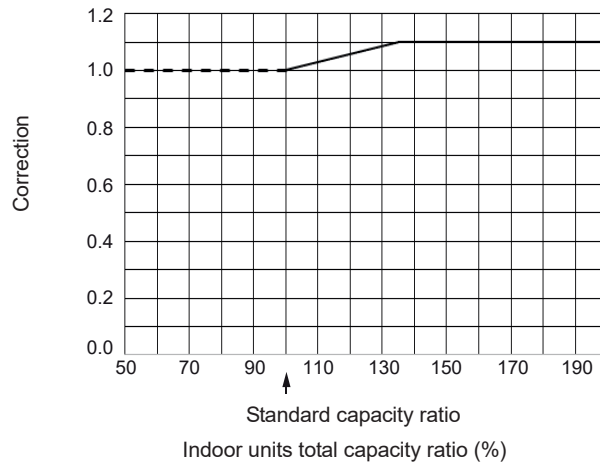

*: Coefficient to use for the correction of the outdoor unit capacity when the total capacity of the indoor units are not equal to the outdoor unit capacity.

2-3-2. Correction charts for heating capacity calculation

[1] Indoor air dry bulb temperature vs. capacity correction value

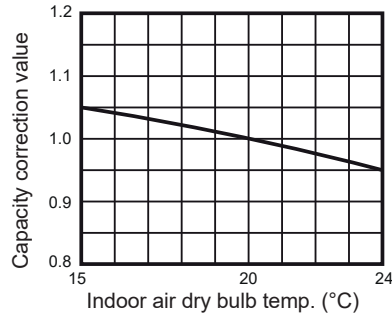

[2] Outdoor air wet bulb temperature vs. capacity correction value

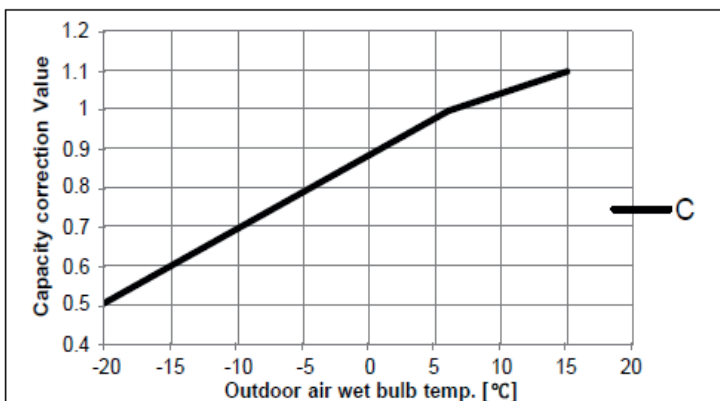
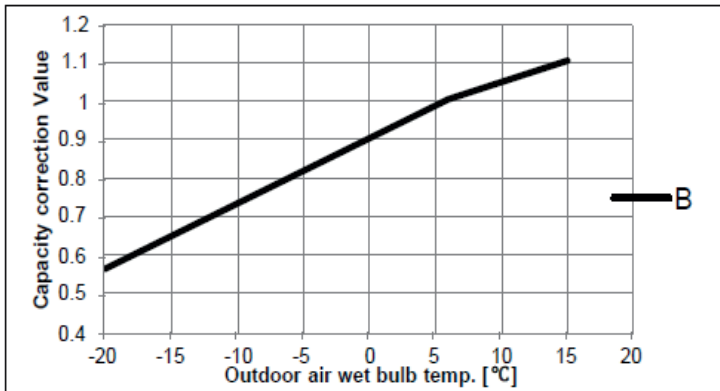
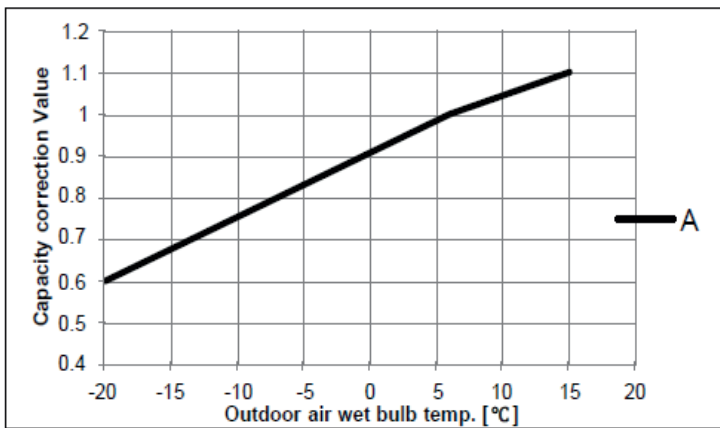

capacity HP	Graph	Combination HP
8	A	8
10	B	10
12	C	12
14	C	14
16	A	16
18	B	18
20	A	20
22	B	22
24	C	24
26	C	14+12
28	C	14+14
30	C	18+12
32	C	20+12
34	C	20+14
36	C	24+12
38	C	24+14
40	A	20+20
42	C	24+18
44	C	24+20
46	C	24+22
48	C	24+24
50	C	24+14+12
52	C	24+14+14
54	C	20+20+14
56	C	24+20+12
58	C	24+20+14
60	C	24+24+12
62	C	24+24+14
64	C	24+20+20
66	C	24+22+20
68	C	24+24+20
70	C	24+24+22
72	C	24+24+24
74	C	24+24+14+12
76	C	24+24+14+14
78	C	24+20+20+14
80	C	24+24+20+12
82	C	24+24+20+14
84	C	24+24+24+12
86	C	24+24+24+14
88	C	24+24+20+20
90	C	24+24+22+20
92	C	24+24+24+20
94	C	24+24+24+22
96	C	24+24+24+24
98	C	24+24+24+14+12
100	C	24+24+24+14+14
102	C	24+24+20+20+14
104	C	24+24+24+20+12
106	C	24+24+24+20+14
108	C	24+24+24+24+12
110	C	24+24+24+24+14
112	C	24+24+24+20+20
114	C	24+24+24+22+20
116	C	24+24+24+24+20
118	C	24+24+24+24+22
120	C	24+24+24+24+24

[3] Connecting pipe length and lift difference between indoor and outdoor units vs. capacity correction value

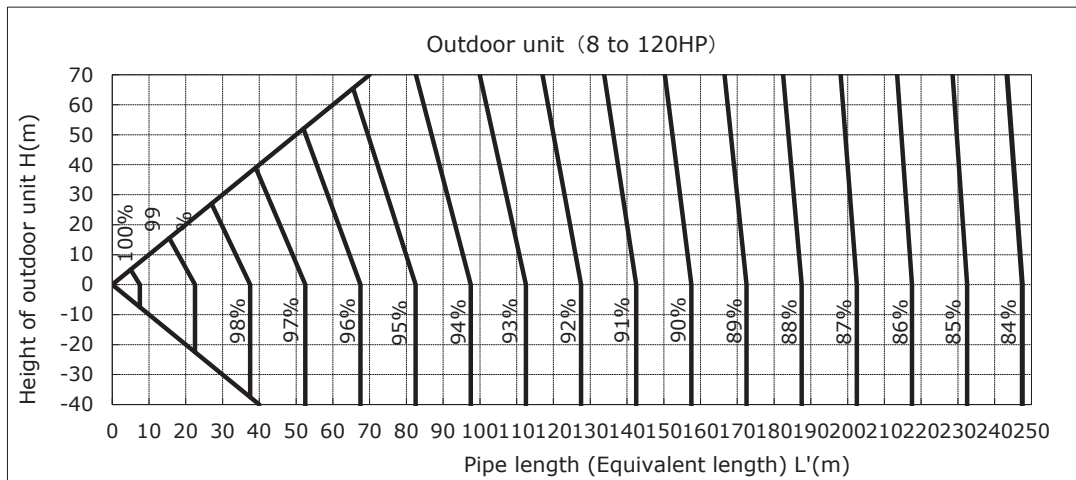
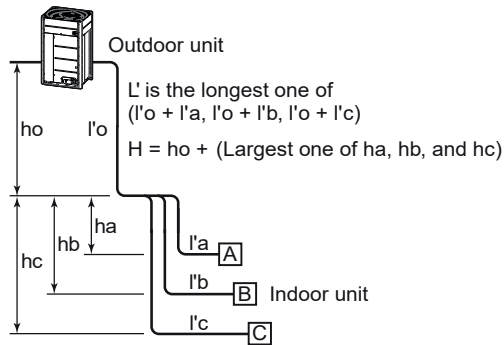

[4]* Correction of outdoor unit diversity

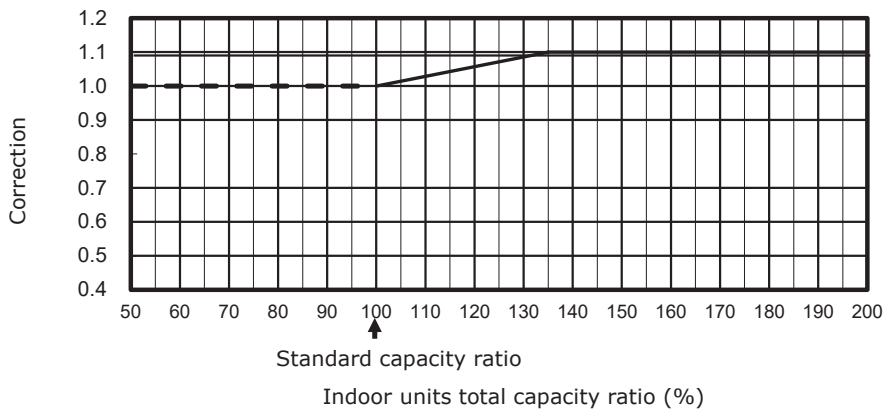

*: Coefficient to use for the correction of the outdoor unit capacity when the total capacity of the indoor units are not equal to the outdoor unit capacity.

2-3-3. Capacity correction in case of frost on the outdoor heat exchanger when in heating

Correct the heating capacity when frost can be found on the outdoor heat exchanger.

Heating capacity = Capacity after correction of outdoor unit x Correction value of capacity resulted from frost
 (Capacity after correction of outdoor unit: Heating capacity calculated in the above item 2.)

[5] Capacity correction in case of frost on the outdoor heat exchanger

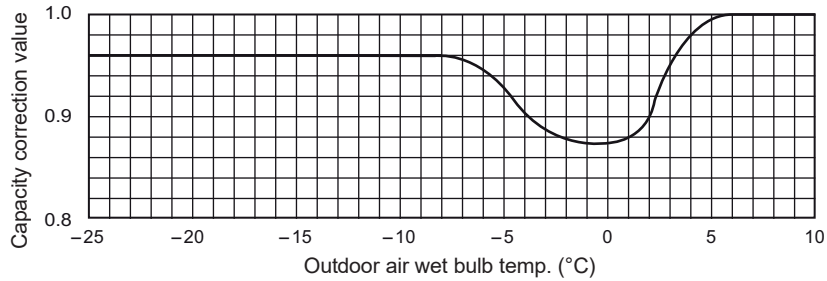

2-3-4. Rated conditions

Cooling: Indoor air temperature 27 °C DB / 19 °C WB, Outdoor air temperature 35 °C DB

Heating: Indoor air temperature 20 °C DB, Outdoor air temperature 7 °C DB / 6 °C WB

2-4. Operational temperature range

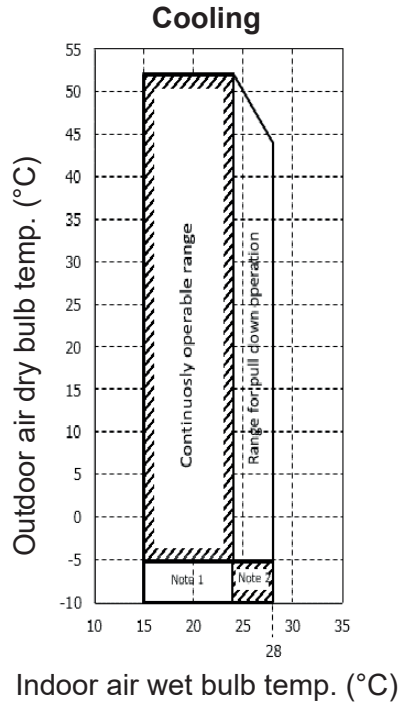

Note

1. NOT SUITABLE FOR APPLICATIONS, WHICH REQUIRE ROOM TEMPERATURE CONTROL, DUE TO INCREASED RISK OF INDOOR ON/OFF CONTROL AND POTENTIAL LOW AIR OFF TEMPERATURES.
2. FOR AREAS THAT DO DEMAND A PRECISE ROOM TEMPERATURE CONTROL, WE WOULD RECOMMEND THE INSTALLATION OF A SECONDARY SYSTEM, WHICH HAS BEEN DESIGNED SOLELY FOR THE PURPOSE OF LOW AMBIENT COOLING.
3. SINGLE OUTDOOR UNIT ONLY.
4. NO HEIGHT DIFFERENCE BETWEEN INDOOR UNITS.
5. THE COOLING PERFORMANCE MAY DECLINE CONSIDERABLY WHEN TOTAL OPERATION CAPACITY OF COOLING INDOOR UNITS IS LESS THAN 4HP WHILE AMBIENT TEMPERATURE IS BELOW -5 C.

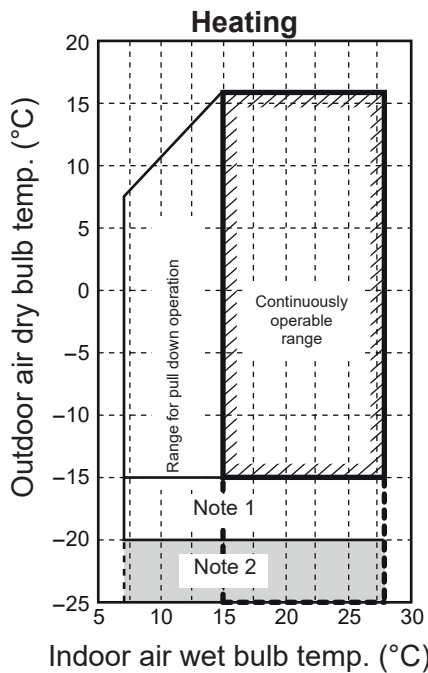

Note 1: The unit will operate down to an outdoor temperature of -25°C, however considerable performance decrease will be expected below -15°C. Therefore please consider installation location/surroundings and system design when expected to operate between -15°C and -20°C.

Note 2: Low ambient heating (-20°C or less) for extended periods of time is not allowed .

3-1. Free branching system

- [1] Line branching system
- [2] Header branching system
- [3] Header branching system after line branching
- [4] Line branching system after header branching
- [5] Header branching system after header branching

The above five branching systems enable to dramatically increase the flexibility of refrigerant piping design.

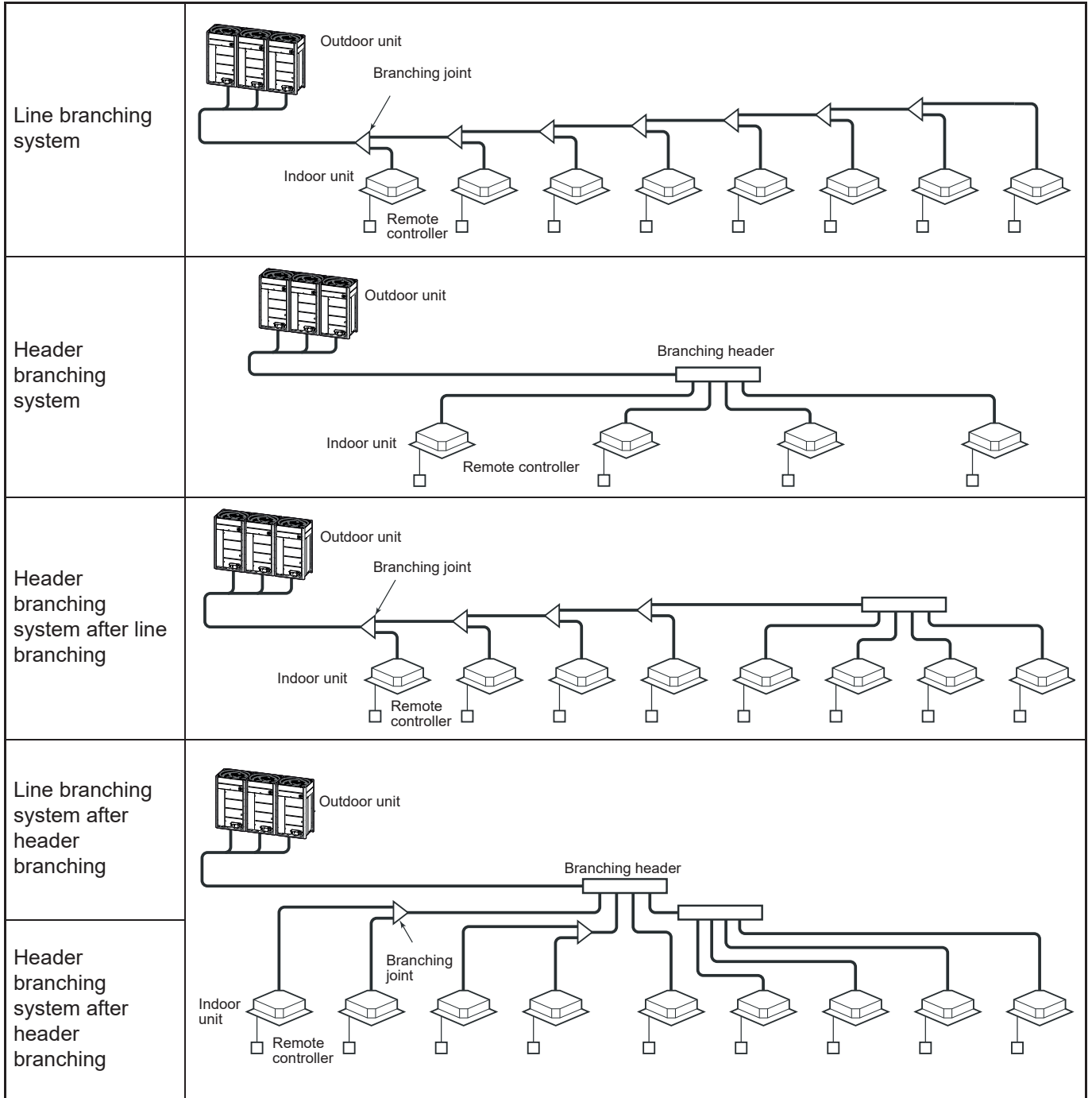

3-2. Allowable length/height difference of refrigerant piping

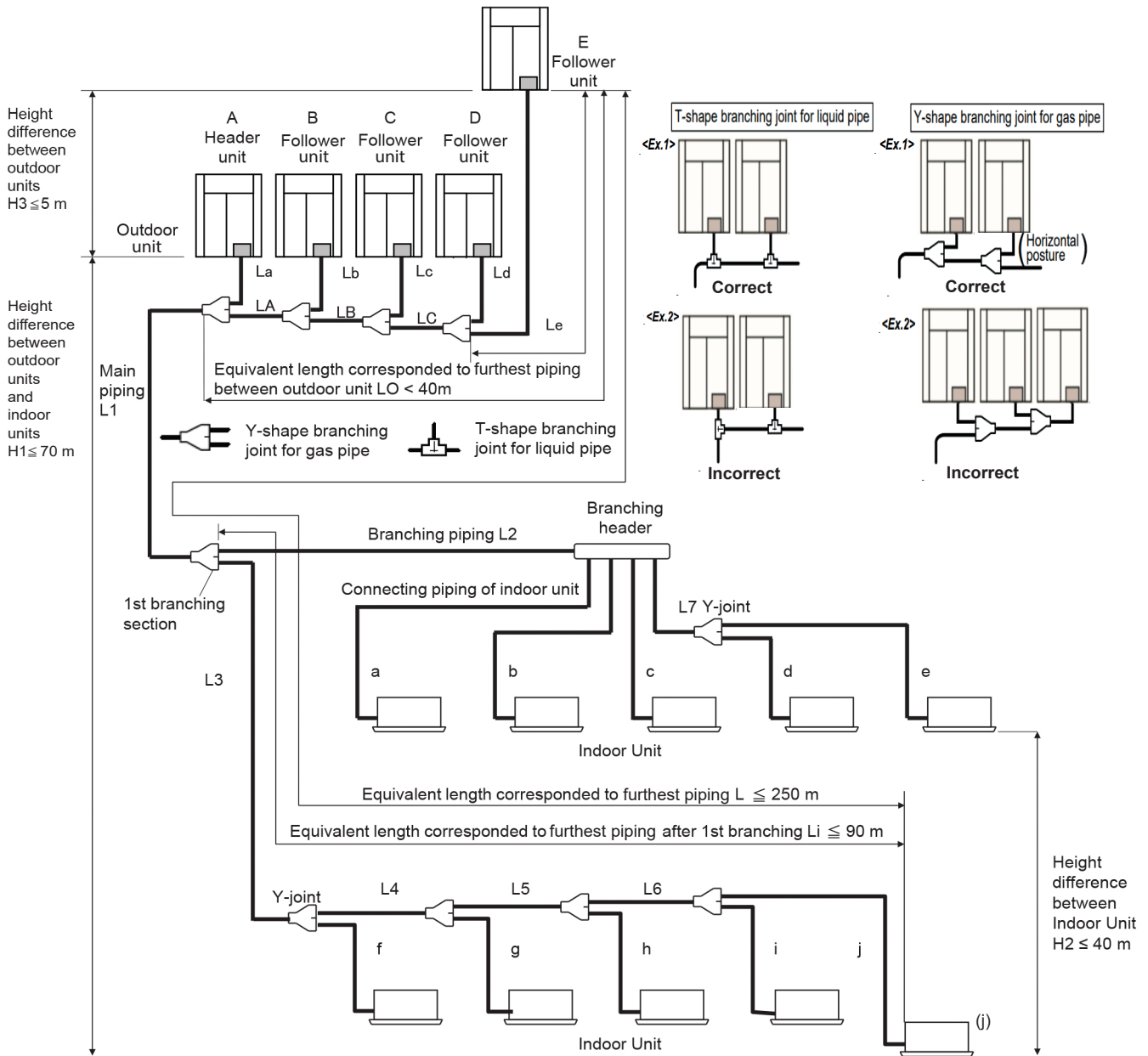

System restrictions

Max. No. of combined outdoor unit	5 Units		
Max. capacity of combined outdoor unit	120 HP		
Max. No. of connected indoor units	128 Units		
Max. capacity of combined indoor units	H2 ≤ 15m	Single outdoor unit system	200 % ※
		Multiple outdoor unit system	150 % ※
	H2 > 15m		105 %

※Limited number of indoor units connected

- Note 1)** Combination of outdoor units: Header unit (1 unit) + Follower units (0 to 4 units). Header unit is the outdoor unit nearest to the connected indoor units.
- Note 2)** Install the outdoor units in order of capacity.
Header unit A ≥ Follower unit B ≥ Follower unit C ≥ Follower unit D ≥ Follower unit E
- Note 3)** Use Y-shape branching joint in connecting of gas pipe for outdoor unit, and install horizontally.
- Note 4)** Piping to indoor units shall be perpendicular to piping to the header outdoor unit as <Ex.1>.
Do not connect piping to indoor units in the same direction of header outdoor unit as T-shape branching joint for liquid pipe of <Ex.2>.

Allowable length and height difference of refrigerant piping

			Allowable value	Piping section
Piping length	Total extension of pipe (Liquid pipe, real length)	Single outdoor unit system	500 m	LA+LB+LC+La+Lb+Lc+Ld+Le+L1+L2+L3+L4+L5+L6+L7+a+b+c+d+e+f+g+h+i+j
		Multiple outdoor unit system	1200 m (*6)	
	Furthest piping Length L (*1)	Equivalent length	250 m	LA+LB+LC+Le+L1+L3+L4+L5+L6+j
		Real length	210 m	
	Equivalent length of furthest piping from 1st branching Li (*1)		90 m (*2)	L3 + L4 + L5 + L6 + j
	Equivalent length of furthest piping between outdoor units LO		40 m	LA+LB+LC+Le (LA+LB+LC+Ld)
	Max. equivalent length of main piping	Equivalent length	120 m (*3)	L1
		Real length	100 m (*3)	
	Max. equivalent length of outdoor unit connecting piping		10 m	La, Lb, Lc, Ld, Le
	Max. real length of indoor unit connecting piping		30 m	a, b, c, d, e, f, g, h, i, j
Max. equivalent length between branches		50 m	L2, L3, L4, L5, L6, L7	
Difference in height	Height between indoor and outdoor units H1	Upper outdoor unit	70 m (*4)(*7)	-
		Lower outdoor unit	40 m (*5)(*8)	-
	Height between indoor units H2		40 m (*9)	-
	Height between outdoor units H3		5 m	-

(*1) : (E) is outdoor unit furthest from the 1st branch and (j) is the indoor unit furthest from the 1st branch.

(*2) : If the height difference between indoor and outdoor units (H1) exceeds 3 m, set 65 m or less.

(*3) : If the max. combined outdoor unit capacity is 54HP or more, then max. equivalent length is 70 m or less (real length is 50 m or less).

(*4) : If the height difference between indoor units (H2) exceeds 3 m, set 50 m or less.

(*5) : If the height difference between indoor units (H2) exceeds 3 m, set 30 m or less.

(*6) : Total charging refrigerant is 140kg or less.

(*7) : Extension up till 110m is possible with conditions below :

- Single outdoor unit system
- Connected ratio of indoor units to outdoor units is below 105%
- Liquid side has been increased 1 size from the standard size
- The height between indoor units (H2) is 3m or less

(*8) : Extension up till 110m is possible with conditions below :

- Multiple outdoor unit system
- Connected Ratio of indoor units to outdoor units is below 105%
- Minimum capacity of connecting indoor unit is more than 3HP
- The height between indoor units (H2) is 3m or less

(*9) : If the connected ratio of indoor units to outdoor units is more than 105%, set 15m or less

3-3. Selection of refrigerant piping

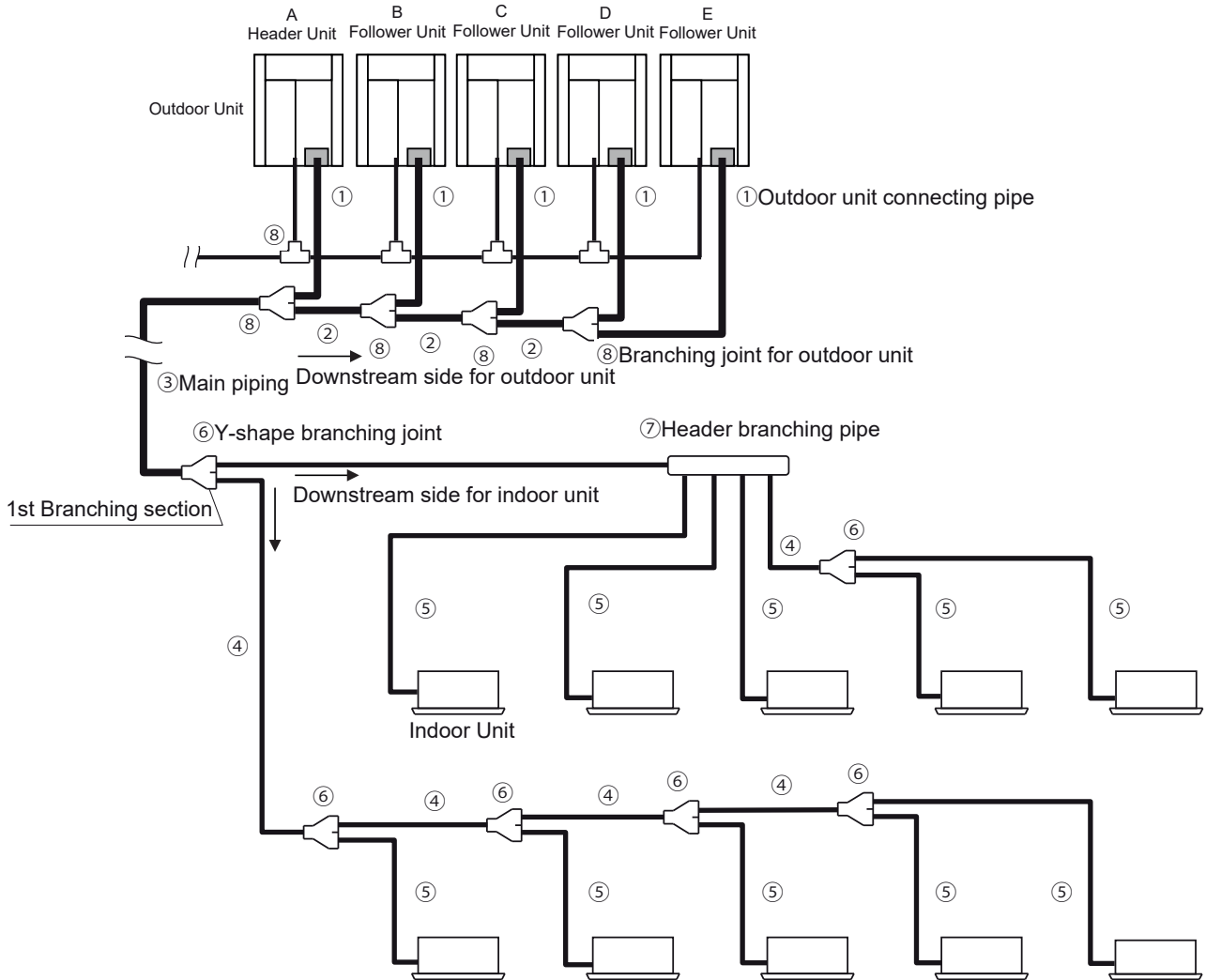

① Pipe size of outdoor unit (Table 1)

Model Name	Gas side	Liquid side
MMY-MUP0801HT8P-E	φ19.1	φ12.7
MMY-MUP1001HT8P-E	φ22.2	φ12.7
MMY-MUP1201HT8P-E	φ28.6	φ12.7
MMY-MUP1401HT8P-E	φ28.6	φ15.9
MMY-MUP1601HT8P-E	φ28.6	φ15.9
MMY-MUP1801HT8P-E	φ28.6	φ15.9
MMY-MUP2001HT8P-E	φ28.6	φ15.9
MMY-MUP2201HT8P-E	φ28.6	φ19.1
MMY-MUP2401HT8P-E1	φ34.9	φ19.1

② Connecting pipe size between outdoor units (Table 2)⁵

Total capacity code of outdoor unit at downstream side (HP)*1	Gas side	Liquid side
16 to 20	φ28.6	φ15.9
22	φ28.6	φ19.1
24	φ34.9	φ19.1
26 to 34	φ34.9	φ19.1
36 to 60	φ41.3	φ22.2
62 to 74	φ54.0 ¹¹	φ22.2
76 or more	φ54.0	φ22.2

③ Size of main pipe (Table 3)

Total capacity code of outdoor unit (*1) (HP)	Gas side	Liquid side		
		Standard pipe	Refrigerant saving pipe size	Allowable length
8	φ19.1	φ12.7	φ9.5	30m
10	φ22.2		-	-
12	φ28.6		φ15.9	φ12.7
14 ~ 18		-		-
20		φ19.1	φ15.9	80m
22			-	-
24 ~ 26	-		-	
28 ~ 34	φ34.9	φ22.2	φ19.1	80m
36 ~ 42			-	-
44 ~ 52	φ41.3 ¹⁰	φ22.2	φ19.1	50m
54	φ41.3		-	-
56 ~ 60		φ54.0 ¹¹	-	-
62 ~ 74			-	-
76 ~ 92	φ54.0	φ22.2 ⁷⁸	-	-
94 or more			-	-

Determine size of the main pipe according to total capacity of outdoor units (HP)

④ Pipe size between branching sections (Table 4)*⁶

Total capacity code of indoor unit at downstream side (HP)	Gas side	Liquid side
Below 2.4	ø12.7	ø9.5
2.4 to below 6.4	ø15.9	ø9.5
6.4 to below 12.2	ø22.2	ø12.7
12.2 to below 20.2	ø28.6	ø15.9
20.2 to below 22.4	ø28.6	ø19.1
22.4 to below 25.2	ø34.9	ø19.1
25.2 to below 35.2	ø34.9	ø19.1
35.2 to below 61.2	ø41.3	ø22.2
61.2 to below 75.2	ø54.0	ø22.2
75.2 or more	ø54.0	ø22.2 ^{*9}

If the total capacity of indoor units (HP) exceeds the total capacity of outdoor units (HP) apply the total capacity of outdoor units (HP).

⑤ Piping of indoor unit (Table 5)

Capacity code of Indoor unit (HP)	Gas side	Liquid side
0.3 to 1.25	ø9.5	ø6.4
Actual length 15 m or less	ø9.5	ø6.4
Actual length exceeds 15 m	ø12.7	ø6.4
1.5 to 2	ø12.7	ø6.4
2.25 to 6	ø15.9	ø9.5
8 to 10	ø22.2	ø12.7
12	ø28.6	ø12.7
14	ø28.6	ø15.9

⑥ Selection of branching section (Table 6)*^{2 *3}

Total capacity code of indoor unit (HP)	Model Name	
Y-shape branching joint	Below 6.4	RBM-BY55E
	6.4 to below 14.2	RBM-BY105E
	14.2 to below 25.2	RBM-BY205E
	25.2 to below 61.2	RBM-BY305E
	61.2 to more	RBM-BY405E

⑦ Selection of branching header for indoor unit (Table 7)*^{2*3*4}

Branching Header	Total capacity code of Indoor unit (HP)		Model Name
	For 4 Branching	Below 14.2	RBM-HY1043E
		14.2 to below 25.2	RBM-HY2043E
	For 8 Branching	Below 14.2	RBM-HY1083E
14.2 to below 25.2		RBM-HY2083E	

⑧ Selection of branching joint for Outdoor Unit (Table 8)*⁵

Total capacity code of outdoor unit at downstream side (HP)* ¹	Model Name
Below 26	RBM-BT14E
26 to below 62	RBM-BT24E
62 to more	RBM-BT34E

Model Name	Gas (Y-Shape)	Liquid (T-Shape)
RBM-BT14E		
RBM-BT24E		
RBM-BT34E		

*1 Capacity code is determined according to outdoor unit capacity rank(HP)

*2 When using a branching for the 1st branching section, select the branching model according to total capacity code of the outdoor units(HP)

*3 When the total capacity code of indoor units(HP) exceeds total capacity code of outdoor units(HP), select the branching model according to total capacity code of outdoor units(HP)

*4 For 1 line after branching header, total maximum capacity of indoor units can be connected is 6HP. When total capacity of outdoor units is 12 HP to below 26HP and the branching header is used as the 1st branching section, apply branching model RBM-HY2043 (4-branch) or RBM-HY2083 (8-branch) regardless of total capacity of indoor units(HP) at the downstream side.If total capacity of outdoor units is more than 26HP, do not use branching header(RBM-HY****) as the 1st branching section.

*5 Downstream side start from the main pipe.

*6 If the piping size exceeds the main piping size, select the size same as the main piping.

*7 Maximum length for the main piping is 30m.

*8 If the length for main piping is extended up to 70m, change the liquid side piping size to ø25.4 (one size up).

*9 If the liquid side piping size of main piping is increased to ø25.4 (one size up), the liquid side piping size also has to change to ø25.4 (one size up)

*10 It is possible to change pipe size from ø41.3 to ø38.1, if it is available at site.

*11 It is possible to change pipe size from ø54.0 to ø44.5, if it is available at site.

3-4. Charging requirement with additional refrigerant

Calculating the amount of additional refrigerant required

Refrigerant in the system when shipped from the factory

Outdoor unit type	MUP0801	MUP1001	MUP1201	MUP1401	MUP1601	MUP1801	MUP2001	MUP2201	MUP2401
Charging amount (kg)	6.0				9.0				

When the system is charged with refrigerant at the factory, the amount of refrigerant needed for the pipes at the site is not included. Therefore, calculate the additional amount needed and add the required amount to the system. (Calculation)

Additional refrigerant charge amount

MMY-MUP***1HT8P-E

Additional refrigerant charge amount at site = [1] + [2] + [3] + [4]

- [1]. Compensation by system HP (Table 1)*
- [2]. Real length of liquid pipe × Additional refrigerant charge amount per liquid pipe 1m (Table 2)
- [3]. Corrective amount of refrigerant depending on the indoor units (Table 3)
- [4]. Corrective amount of refrigerant depending on the outdoor unit diversity (Connected ratio of indoor units to outdoor units). (Table 4)

* If combination of the outdoor unit is not same as listed at Table 1, calculate the correction amount refrigerant of the combination outdoor units refers to the each outdoor unit's additional refrigerant.

Table 1
Basic model

System HP	Combination HP					Compensation by system HP (kg)
8	8	-	-	-	-	1.5
10	10	-	-	-	-	1.7
12	12	-	-	-	-	2.3
14	14	-	-	-	-	2.3
16	16	-	-	-	-	1.0
18	18	-	-	-	-	2.0
20	20	-	-	-	-	4.0
22	22	-	-	-	-	5.0
24	24	-	-	-	-	5.5
26	14	12	-	-	-	4.6
28	14	14	-	-	-	4.6
30	18	12	-	-	-	4.3
32	20	12	-	-	-	6.3
34	20	14	-	-	-	6.3
36	24	12	-	-	-	7.8
38	24	14	-	-	-	7.8
40	20	20	-	-	-	8.0
42	24	18	-	-	-	7.5
44	24	20	-	-	-	9.5
46	24	22	-	-	-	10.5
48	24	24	-	-	-	11.0
50	24	14	12	-	-	10.1
52	24	14	14	-	-	10.1
54	20	20	14	-	-	10.3
56	24	20	12	-	-	11.8
58	24	20	14	-	-	11.8
60	24	24	12	-	-	13.3

System HP	Combination HP					Compensation by system HP (kg)
62	24	24	14	-	-	13.3
64	24	20	20	-	-	13.5
66	24	22	20	-	-	14.5
68	24	24	20	-	-	15.0
70	24	24	22	-	-	16.0
72	24	24	24	-	-	16.5
74	24	24	14	12	-	15.6
76	24	24	14	14	-	15.6
78	24	20	20	14	-	15.8
80	24	24	20	12	-	17.3
82	24	24	20	14	-	17.3
84	24	24	24	12	-	18.8
86	24	24	24	14	-	18.8
88	24	24	20	20	-	19.0
90	24	24	22	20	-	20.0
92	24	24	24	20	-	20.5
94	24	24	24	22	-	21.5
96	24	24	24	24	-	22.0
98	24	24	24	14	12	21.1
100	24	24	24	14	14	21.1
102	24	24	20	20	14	21.3
104	24	24	24	20	12	22.8
106	24	24	24	20	14	22.8
108	24	24	24	24	12	24.3
110	24	24	24	24	14	24.3
112	24	24	24	20	20	24.5
114	24	24	24	22	20	25.5
116	24	24	24	24	20	26.0
118	24	24	24	24	22	27.0
120	24	24	24	24	24	27.5

Table 2

Liquid pipe dia. (mm)	6.4	9.5	12.7	15.9	19.1	22.2	25.4
Additional refrigerant amount per 1m liquid pipe (kg/m)	0.025	0.055	0.105	0.160	0.250	0.350	0.470

Table 3-1

Corrective amount of refrigerant varies according to indoor unit capacity rank

Indoor unit Capacity rank	003	005	007	008	009	010	012	014	015	018	020	024	027	030	034	036	042	048	056	072	096
Capacity code (Equivalent to HP)	0.3	0.6	0.8	0.9	1	1.1	1.2 5	1.5	1.7	2	2.2 5	2.5	3	3.2	3.6	4	4.5	5	6	8	10
Corrective amount of refrigerant (kg)	0.2							0.4					0.6				1.0				

* If the Fresh Air Intake indoor Unit (MMD-UP****HFP*) is connected, the correction amount refrigerant for Fresh Air Intake Unit is 0 kg.

Table 3-2

Corrective amount of refrigerant varies for DX Coil Interface

TCB-IFDTA201E, TCB-IFDDC201E

Capacity code (Equivalent to HP)	8	10	16	18	20	32	34	36	40	48	54	60
Corrective amount of refrigerant (kg)	1.4	1.8	2.9	3.2	3.6	5.8	6.1	6.5	7.2	8.6	9.7	10.8

TCB-IFDMR01UP-E, TCB-IFDMX01UP-E

For the TA, DDC type, the corrective amount of refrigerant is below.

Capacity code (Equivalent to HP)	8	10	12	14	16	18	20	22	24	26	28	30	32	34	36	38	40	42	44	46	48	50
Corrective amount of refrigerant (kg)	1.4	1.8	2.1	2.5	2.9	3.2	3.6	3.9	4.3	4.6	5.0	5.3	5.8	6.1	6.5	6.8	7.2	7.5	7.9	8.2	8.6	8.9
Capacity code (Equivalent to HP)	52	54	56	58	60	62	64	66	68	70	72	74	76	78	80	82	84	86	88	90	92	94
Corrective amount of refrigerant (kg)	9.3	9.7	10.0	10.4	10.8	11.1	11.5	11.8	12.2	12.5	12.9	13.3	13.6	14.0	14.3	14.7	15.1	15.4	15.8	16.1	16.5	16.9
Capacity code (Equivalent to HP)	106	108	110	112	114	96	98	100	102	104	116	118	120									
Corrective amount of refrigerant (kg)	19.0	19.4	19.7	20.1	20.5	17.2	17.6	17.9	18.3	18.7	8.5	21.2	21.5									

* TF Type : The corrective amount of refrigerant is 0 kg.

Table 3-3

Corrective amount of refrigerant varies for Hot Water Module

Indoor unit Capacity rank	024	048
Capacity code (Equivalent to HP)	2.5	5
Corrective amount of refrigerant (kg)	0.2	

Table 3-4

Corrective amount of refrigerant varies for (MMU-UP****H-E) High Efficiency 4 Way Cassete

Indoor unit Capacity rank	009	012	015	018	024	027	030	036	048	056
Capacity code (Equivalent to HP)	1	1.25	1.7	2	2.5	3	3.2	4	5	6
Corrective amount of refrigerant (kg)	0.2		0.6							

Table 4

Corrective amount of refrigerant varies according to the outdoor unit diversity

Diversity D (%)	Corrective amount of refrigerant (kg)
50% ≤ D < 60%	-2.5
60% ≤ D < 70%	-2.0
70% ≤ D < 80%	-1.5
80% ≤ D < 90%	-1.0
90% ≤ D < 95%	-0.5
95% ≤ D	0

4-1. General

- Perform wiring of the power supply in conformance with the regulations of the local electric company.
- For cabling of the power supply of the indoor unit and the inter-unit cabling between indoor and outdoor units, refer to the Installation Manual of indoor unit.
- Never connect power supply to the terminal block (Uv, Uh, Uc) for control wiring. (The equipment breaks down.)
- Arrange the cables so that the electric wires do not come to contact with high-temperature part of the pipe; otherwise coating melts and an accident may be caused.
- After connecting cable to the terminal block, take off the trap and then fix the cable with cable clamp.
- Do not turn on power of the indoor unit until vacuuming of the refrigerant pipe will finish.

4-2. Summary of wiring design

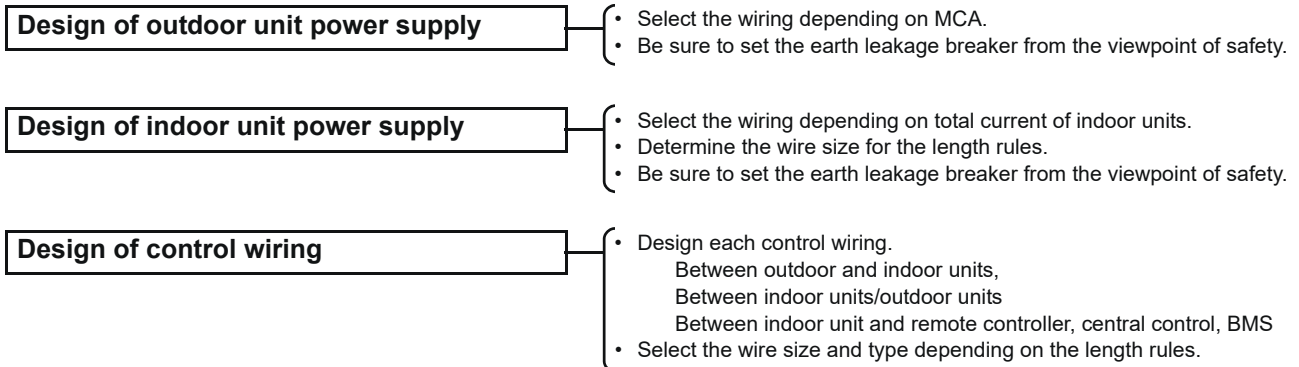

4-3. Electrical wiring design

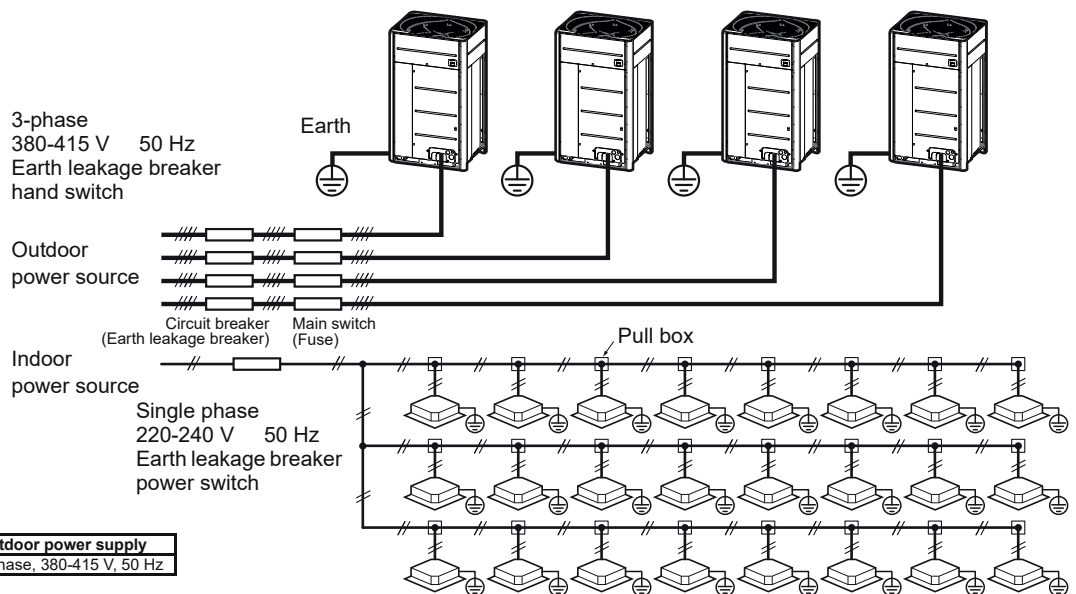

- Wiring size must comply with the applicable local and national code.
- Determine the wire size for the indoor unit according to the number of connected indoor units downstream.

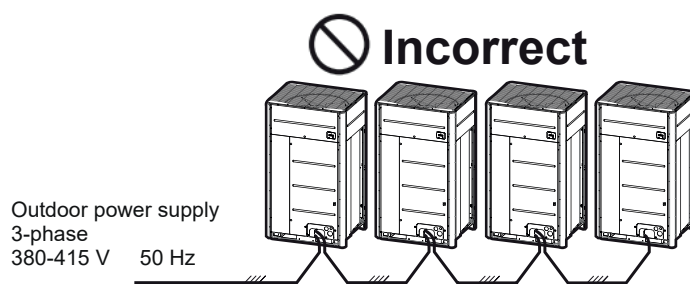

4-4.Outdoor unit power supply

- Select the power supply cabling and fuse of each outdoor unit from the following specifications:
cable 4-core, in conformance with Design 60245 IEC 66
- Do not connect the outdoor units by crossing outside of them, but connect them via the terminal block (L1, L2, L3, N).

Outdoor unit data

Basic model

HP	Heat pump Model	Power Supply		Voltage Range		Compressor					Fan Motor		MCA	MOCP	
		Phase and frequency	Minimum Voltage	Maximum Voltage	Unit No.1 (kW)	Unit No.2 (kW)	Unit No.3 (kW)	Unit No.4 (kW)	Unit No.5 (kW)	(kW)	(A)	(A)			(A)
8	MMY-MUP0801HT8P-E	3N~50Hz	380-400-415V	342	456	5.25							1.0	17	20
10	MMY-MUP1001HT8P-E	3N~50Hz	380-400-415V	342	456	7.93							1.0	23	32
12	MMY-MUP1201HT8P-E	3N~50Hz	380-400-415V	342	456	9.75							1.0	27	32
14	MMY-MUP1401HT8P-E	3N~50Hz	380-400-415V	342	456	14.0							1.0	31	40
16	MMY-MUP1601HT8P-E	3N~50Hz	380-400-415V	342	456	13.2							2.0	34	40
18	MMY-MUP1801HT8P-E	3N~50Hz	380-400-415V	342	456	14.5							2.0	38	50
20	MMY-MUP2001HT8P-E	3N~50Hz	380-400-415V	342	456	16.9							2.0	40	50
22	MMY-MUP2201HT8P-E	3N~50Hz	380-400-415V	342	456	9.61 × 2							2.0	57	63
24	MMY-MUP2401HT8P-E1	3N~50Hz	380-400-415V	342	456	11.4 × 2							2.0	60	80

4-5. Indoor unit power supply

• Electrical characteristics

Type	Model name	Normal Voltage (V-Ph-Hz)	Voltage Range		Fan Motor		Power Supply	
			Min.	Max.	kW	FLA	MCA	MOCP
Smart 4-Way Air Discharge Type	MMU-UP0091H-E	230-1-50	198	264	0.060	0.20	0.25	15
	MMU-UP0121H-E	230-1-50	198	264	0.060	0.20	0.25	15
	MMU-UP0151H-E	230-1-50	198	264	0.130	0.22	0.28	15
	MMU-UP0181H-E	230-1-50	198	264	0.130	0.29	0.36	15
	MMU-UP0241H-E	230-1-50	198	264	0.130	0.42	0.52	15
	MMU-UP0271H-E	230-1-50	198	264	0.130	0.53	0.66	15
	MMU-UP0301H-E	230-1-50	198	264	0.130	0.66	0.83	15
	MMU-UP0361H-E	230-1-50	198	264	0.130	1.03	1.29	15
	MMU-UP0481H-E	230-1-50	198	264	0.130	1.06	1.32	15
4-Way Air Discharge Cassette Type	MMU-UP0561H-E	230-1-50	198	264	0.130	1.07	1.33	15
	MMU-UP0091HP-E	230-1-50	198	264	0.060	0.63	0.79	15
	MMU-UP0121HP-E	230-1-50	198	264	0.060	0.63	0.79	15
	MMU-UP0151HP-E	230-1-50	198	264	0.060	0.80	1.00	15
	MMU-UP0181HP-E	230-1-50	198	264	0.060	0.80	1.00	15
	MMU-UP0241HP-E	230-1-50	198	264	0.060	0.87	1.09	15
	MMU-UP0271HP-E	230-1-50	198	264	0.060	0.87	1.09	15
	MMU-UP0301HP-E	230-1-50	198	264	0.060	0.87	1.09	15
	MMU-UP0361HP-E	230-1-50	198	264	0.130	1.15	1.44	15
Compact 4-way Cassette Type	MMU-UP0481HP-E	230-1-50	198	264	0.130	1.15	1.44	15
	MMU-UP0561HP-E	230-1-50	198	264	0.130	1.15	1.44	15
	MMU-UP0051MH-E	230-1-50	198	264	0.060	0.18	0.23	15
	MMU-UP0071MH-E	230-1-50	198	264	0.060	0.26	0.33	15
	MMU-UP0091MH-E	230-1-50	198	264	0.060	0.28	0.35	15
	MMU-UP0121MH-E	230-1-50	198	264	0.060	0.29	0.36	15
2-Way Air Discharge Cassette Type	MMU-UP0151MH-E	230-1-50	198	264	0.060	0.32	0.40	15
	MMU-UP0181MH-E	230-1-50	198	264	0.060	0.53	0.66	15
	MMU-UP0071WH-E	230-1-50	198	264	0.060	0.24	0.30	15
	MMU-UP0091WH-E	230-1-50	198	264	0.060	0.24	0.30	15
	MMU-UP0121WH-E	230-1-50	198	264	0.060	0.24	0.30	15
	MMU-UP0151WH-E	230-1-50	198	264	0.060	0.25	0.31	15
	MMU-UP0181WH-E	230-1-50	198	264	0.094	0.32	0.40	15
	MMU-UP0241WH-E	230-1-50	198	264	0.094	0.43	0.54	15
	MMU-UP0271WH-E	230-1-50	198	264	0.094	0.43	0.54	15
1-Way Air Discharge Cassette Type	MMU-UP0301WH-E	230-1-50	198	264	0.094	0.50	0.63	15
	MMU-UP0361WH-E	230-1-50	198	264	0.139	0.58	0.73	15
	MMU-UP0481WH-E	230-1-50	198	264	0.139	0.65	0.81	15
	MMU-UP0561WH-E	230-1-50	198	264	0.139	0.89	1.11	15
	MMU-UP0031YHP-E	230-1-50	198	264	0.030	0.32	0.40	15
	MMU-UP0051YHP-E	230-1-50	198	264	0.030	0.32	0.40	15
	MMU-UP0071YHP-E	230-1-50	198	264	0.030	0.32	0.40	15
	MMU-UP0091YHP-E	230-1-50	198	264	0.030	0.32	0.40	15
	MMU-UP0121YHP-E	230-1-50	198	264	0.030	0.32	0.40	15
	MMU-UP0151YHP-E	230-1-50	198	264	0.042	0.58	0.73	15
	MMU-UP0181YHP-E	230-1-50	198	264	0.042	0.58	0.73	15
	MMU-UP0241YHP-E	230-1-50	198	264	0.059	0.80	1.00	15
Concealed Duct Type	MMU-UP0271YHP-E	230-1-50	198	264	0.059	0.80	1.00	15
	MMU-UP0151SH-E	230-1-50	198	264	0.094	0.39	0.49	15
	MMU-UP0181SH-E	230-1-50	198	264	0.094	0.41	0.51	15
	MMU-UP0241SH-E	230-1-50	198	264	0.094	0.62	0.78	15
	MMD-UP0051BHP-E	230-1-50	198	264	0.150	0.75	0.94	15
	MMD-UP0071BHP-E	230-1-50	198	264	0.150	0.75	0.94	15
	MMD-UP0091BHP-E	230-1-50	198	264	0.150	0.75	0.94	15
	MMD-UP0121BHP-E	230-1-50	198	264	0.150	0.75	0.94	15
	MMD-UP0151BHP-E	230-1-50	198	264	0.150	1.24	1.55	15
	MMD-UP0181BHP-E	230-1-50	198	264	0.150	1.24	1.55	15
	MMD-UP0241BHP-E	230-1-50	198	264	0.150	1.58	1.98	15
	MMD-UP0271BHP-E	230-1-50	198	264	0.150	1.58	1.98	15
MMD-UP0301BHP-E	230-1-50	198	264	0.150	1.78	2.23	15	
MMD-UP0361BHP-E	230-1-50	198	264	0.250	2.19	2.74	15	
MMD-UP0481BHP-E	230-1-50	198	264	0.250	2.66	3.33	15	
MMD-UP0561BHP-E	230-1-50	198	264	0.250	2.66	3.33	15	

Type	Model name	Normal Voltage (V-Ph-Hz)	Voltage Range		Fan Motor		Power Supply	
			Min.	Max.	kW	FLA	MCA	MOCP
Slim Duct Type	MMD-UP0031SPHY-E	230-1-50	198	264	0.050	0.39	0.49	15
	MMD-UP0051SPHY-E	230-1-50	198	264	0.050	0.41	0.51	15
	MMD-UP0071SPHY-E	230-1-50	198	264	0.050	0.46	0.57	15
	MMD-UP0091SPHY-E	230-1-50	198	264	0.050	0.48	0.60	15
	MMD-UP0121SPHY-E	230-1-50	198	264	0.050	0.51	0.63	15
	MMD-UP0151SPHY-E	230-1-50	198	264	0.094	0.54	0.67	15
	MMD-UP0181SPHY-E	230-1-50	198	264	0.094	0.61	0.76	15
	MMD-UP0241SPHY-E	230-1-50	198	264	0.094	0.80	1.00	15
	MMD-UP0271SPHY-E	230-1-50	198	264	0.095	0.85	1.06	15
Concealed Duct High Static Pressure Type	MMD-UP0181HP-E	230-1-50	198	264	0.250	1.02	1.28	15
	MMD-UP0241HP-E	230-1-50	198	264	0.250	1.33	1.66	15
	MMD-UP0271HP-E	230-1-50	198	264	0.250	1.33	1.96	15
	MMD-UP0361HP-E	230-1-50	198	264	0.350	2.22	2.78	15
	MMD-UP0481HP-E	230-1-50	198	264	0.350	2.40	2.99	15
	MMD-UP0561HP-E	230-1-50	198	264	0.350	2.57	3.22	15
	MMD-UP0721HP-E1	230-1-50	198	264	1.000	4.30	5.40	15
	MMD-UP0961HP-E1	230-1-50	198	264	1.000	5.50	6.90	15
Ceiling Type	MMC-UP0151HP-E	230-1-50	198	264	0.094	0.41	0.52	15
	MMC-UP0181HP-E	230-1-50	198	264	0.094	0.42	0.53	15
	MMC-UP0241HP-E	230-1-50	198	264	0.094	0.75	0.93	15
	MMC-UP0271HP-E	230-1-50	198	264	0.094	0.75	0.93	15
	MMC-UP0361HP-E	230-1-50	198	264	0.139	0.89	1.11	15
	MMC-UP0481HP-E	230-1-50	198	264	0.139	0.89	1.11	15
	MMC-UP0561HP-E	230-1-50	198	264	0.139	1.14	1.43	15
High Wall Type	MMK-UP0031HP-E	230-1-50	198	264	0.030	0.16	0.21	15
	MMK-UP0051HP-E	230-1-50	198	264	0.030	0.16	0.21	15
	MMK-UP0071HP-E	230-1-50	198	264	0.030	0.17	0.21	15
	MMK-UP0091HP-E	230-1-50	198	264	0.030	0.18	0.23	15
	MMK-UP0121HP-E	230-1-50	198	264	0.030	0.20	0.25	15
	MMK-UP0151HP-E	230-1-50	198	264	0.042	0.30	0.38	15
	MMK-UP0181HP-E	230-1-50	198	264	0.042	0.33	0.41	15
	MMK-UP0241HP-E	230-1-50	198	264	0.042	0.48	0.60	15
	MMK-UP0271HP-E	230-1-50	198	264	0.061	0.66	0.83	15
	MMK-UP0301HP-E	230-1-50	198	264	0.061	0.66	0.83	15
	MMK-UP0361HP-E	230-1-50	198	264	0.061	0.66	0.83	15
Floor Standing Concealed Type	MML-UP0071BH-E	230-1-50	198	264	0.019	0.29	0.36	15
	MML-UP0091BH-E	230-1-50	198	264	0.019	0.29	0.36	15
	MML-UP0121BH-E	230-1-50	198	264	0.019	0.29	0.36	15
	MML-UP0151BH-E	230-1-50	198	264	0.070	0.52	0.65	15
	MML-UP0181BH-E	230-1-50	198	264	0.070	0.52	0.65	15
	MML-UP0241BH-E	230-1-50	198	264	0.070	0.53	0.66	15
Floor Standing Cabinet Type	MML-UP0071H-E	230-1-50	198	264	0.045	0.30	0.37	15
	MML-UP0091H-E	230-1-50	198	264	0.045	0.30	0.37	15
	MML-UP0121H-E	230-1-50	198	264	0.045	0.49	0.62	15
	MML-UP0151H-E	230-1-50	198	264	0.045	0.49	0.62	15
	MML-UP0181H-E	230-1-50	198	264	0.070	0.54	0.68	15
	MML-UP0241H-E	230-1-50	198	264	0.070	0.54	0.68	15
Floor Standing Type	MMF-UP0151H-E	230-1-50	198	264	0.062	0.42	0.53	15
	MMF-UP0181H-E	230-1-50	198	264	0.062	0.42	0.53	15
	MMF-UP0241H-E	230-1-50	198	264	0.062	0.63	0.79	15
	MMF-UP0271H-E	230-1-50	198	264	0.062	0.63	0.79	15
	MMF-UP0361H-E	230-1-50	198	264	0.109	0.94	1.18	15
	MMF-UP0481H-E	230-1-50	198	264	0.109	1.12	1.40	15
MMF-UP0561H-E	230-1-50	198	264	0.109	1.12	1.40	15	

Type	Model name	Normal Voltage	Voltage Range		Fan Motor		Power Supply	
		(V-Ph-Hz)	Min.	Max.	kW	FLA	MCA	MOCP
Console Type	MML-UP0071NHP-E	230-1-50	198	264	0.041	0.21	0.26	15
	MML-UP0091NHP-E	230-1-50	198	264	0.041	0.21	0.26	15
	MML-UP0121NHP-E	230-1-50	198	264	0.041	0.25	0.31	15
	MML-UP0151NHP-E	230-1-50	198	264	0.041	0.32	0.40	15
	MML-UP0181NHP-E	230-1-50	198	264	0.041	0.46	0.58	15
Hot Water Module	MMW-UP0271LQ-E	230-1-50	198	264	-	-	0.90	15
	MMW-UP0561LQ-E	230-1-50	198	264	-	-	0.90	15
Fresh Air Intake Indoor unit Type	MMD-UP0481HFP-E	230-1-50	198	264	0.350	1.42	1.77	15
	MMD-UP0721HFP-E1	230-1-50	198	264	1.000	1.83	2.29	15
	MMD-UP0961HFP-E1	230-1-50	198	264	1.000	2.26	2.82	15
	MMD-UP1121HFP-E1	230-1-50	198	264	1.000	2.53	3.18	15
	MMD-UP1281HFP-E1	230-1-50	198	264	1.000	2.89	3.62	15

• Wiring size

Must be independent from the outdoor unit power supply

Model \ Item	Power supply wiring			
	Wire size			
All models of indoor units	2.0 mm ² (AWG#14)	Max. 20 m	3.5 mm ² (AWG#12)	Max. 50 m

NOTE:

The above connecting lengths stated in the table, indicate the length from the isolator to the outdoor unit. When the power supply of the indoor units are connected in parallel, it is assumed that no more than a 2 % voltage drop will occur. If the connecting length is to exceed the stated lengths, select a suitable wire in accordance with the local wiring standards.

4-6.Design of control wiring

• Summary of control wiring

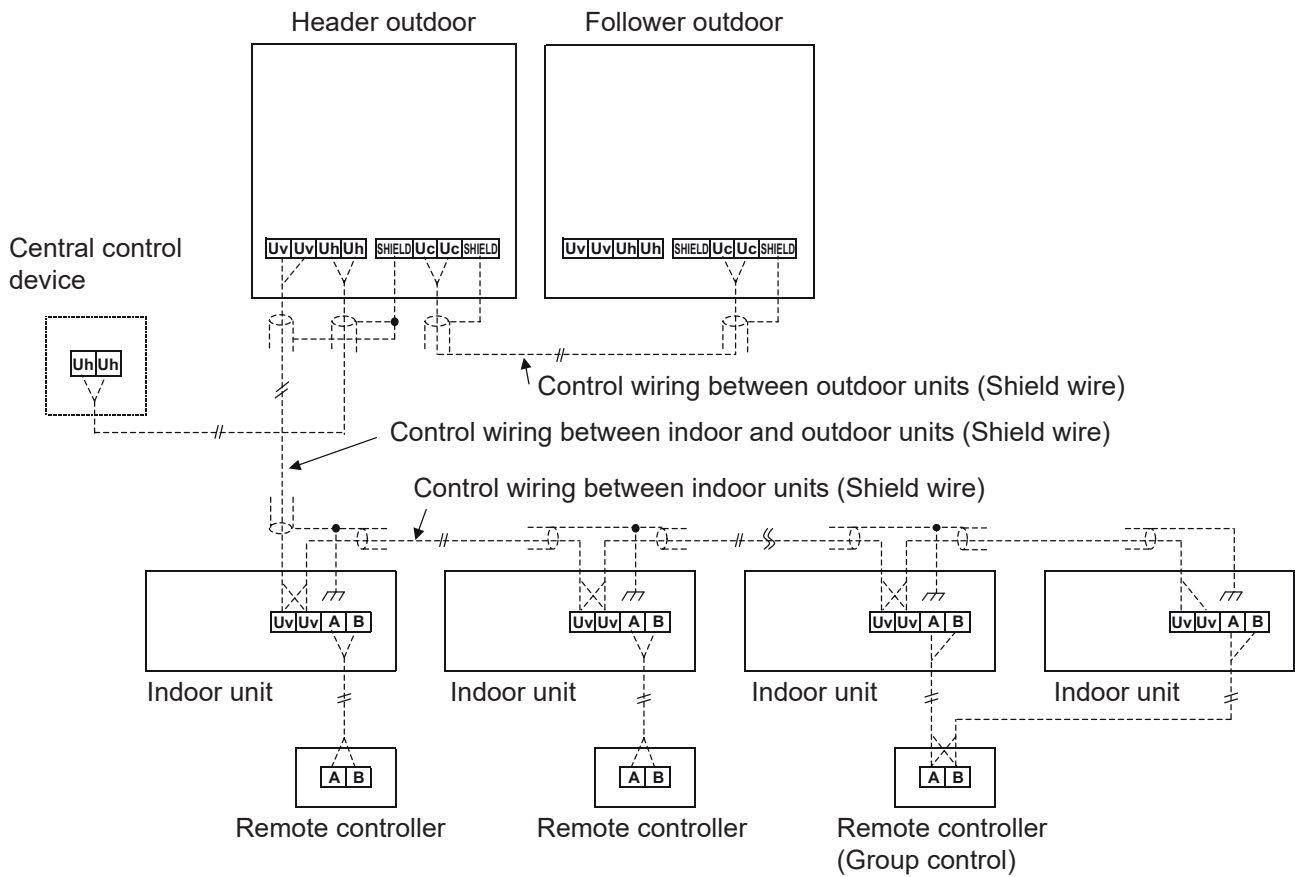

- Communication wiring and central control wiring use 2-core non-polarity wires.
Use 2-core shield wires to prevent noise trouble.
In this case, ends of the communication wire must be grounded.
- Use 2-core non-polarity wire for remote control. (A, B terminals)
Use 2-core non-polarity wire for wiring of group control. (A, B terminals)

• **Restriction of control wiring**

Be sure to keep the rule of below tables about size and length of control wiring.

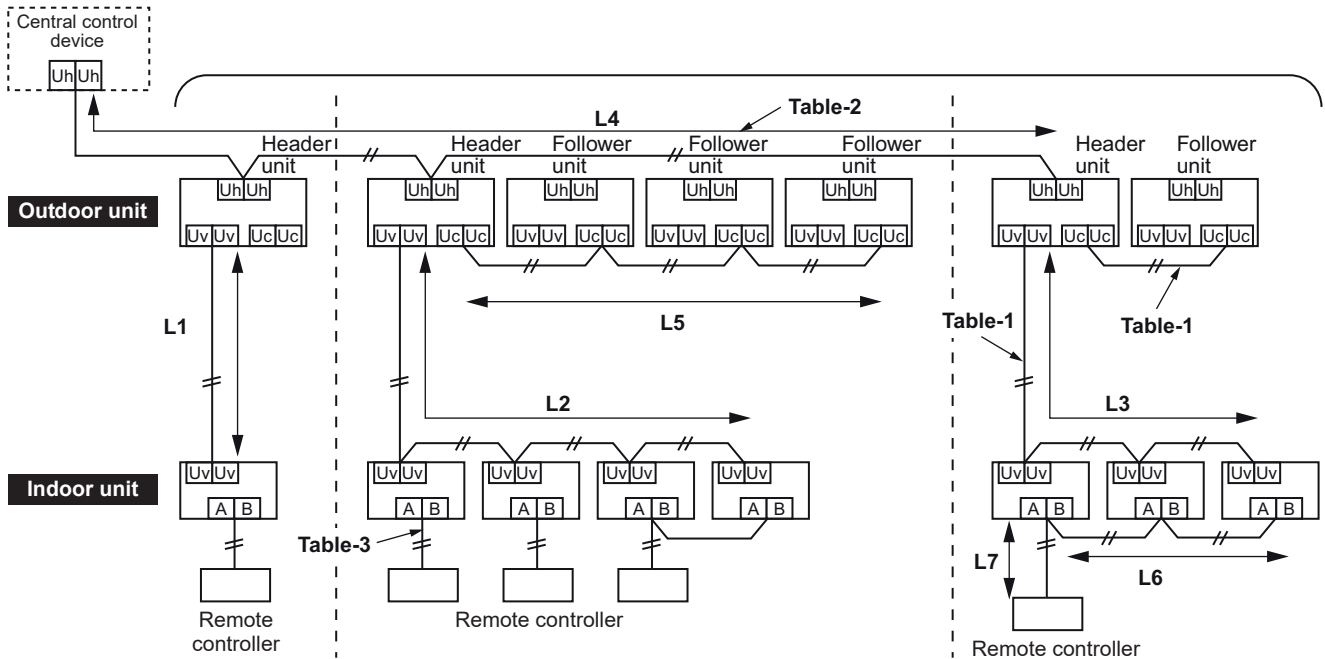

Table-1 Uv Line - Control wiring between indoor and outdoor units (L1, L2, L3) + Uc Line - between outdoor units (L5)

Wiring	2-core, non-polarity
Type	Shield wire
Size/Length	1.0 mm ² to 1.5 mm ² : Up to 1000 m (*1)

Note (*1): Uv + Uc Line are independent from another Refrigerant Line. Each Refrigerant Line are up to 1000 m. L1 is up to 1000 m, (L2 + L5) is up to 1000 m.

Table-2 Uh Line - Central control wiring (L4)

Wiring	2-core, non-polarity
Type	Shield wire
Size/Length	1.0 mm ² to 1.5 mm ² : Up to 1000 m 2.0 mm ² : Up to 2000 m

Table-3 Remote controller wiring (L6, L7)

Wire	2-core, non-polarity
Size	0.5 mm ² to 2.0 mm ²
Length	<ul style="list-style-type: none"> • Up to 500 m (L6 + L7) • Up to 400 m in case of wireless remote controller in group control. • Up to 200 m total length of control wiring between indoor units (L6)

• **Group Operation through a Remote Controller**

Group operation of multiple indoor units (16 units) through a single remote controller switch

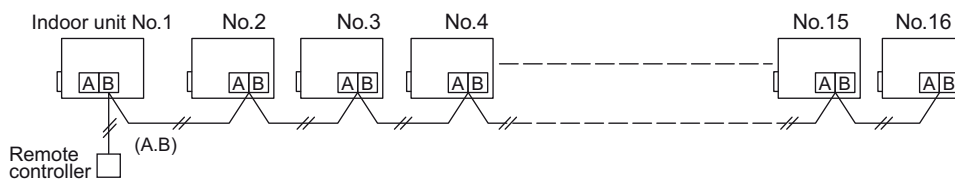

5-1. Specifications

Basic model

Model name			MMY-MUP0801HT8P-E	MMY-MUP1001HT8P-E	MMY-MUP1201HT8P-E	MMY-MUP1401HT8P-E	
Outdoor unit type			Inverter unit	Inverter unit	Inverter unit	Inverter unit	
Cooling capacity (*1)	kW		22.4	28.0	33.5	40.0	
Heating capacity (Rated. *1)	kW		22.4	28.0	33.5	40.0	
Heating capacity (Max. *1)	kW		25.0	31.5	37.5	45.0	
Capacity range	HP		8	10	12	14	
Power supply			3N~ 50Hz 400V(380-415V)	3N~ 50Hz 400V(380-415V)	3N~ 50Hz 400V(380-415V)	3N~ 50Hz 400V(380-415V)	
Voltage range (*2)	Minimum	V	342	342	342	342	
	Maximum	V	456	456	456	456	
Electrical characteristic (*1)	Cooling	Running current	A	9.15	13.4	16.0	22.6
		Power input	kW	5.64	8.36	10.34	14.55
		EER	kW/kW	3.97	3.35	3.24	2.75
	Heating (Rated.)	Running current	A	8.56	11.5	12.1	15.5
		Power input	kW	5.28	7.20	7.77	10.00
		COP	kW/kW	4.24	3.89	4.31	4.00
	Heating (Max.)	Running current	A	9.73	13.3	13.8	18.8
		Power input	kW	6.00	8.29	8.87	12.13
		COP	kW/kW	4.17	3.80	4.23	3.71
	SEER			7.44	7.73	7.32	7.05
	SCOP			4.50	4.78	4.75	4.60
	Starting current	A		Soft Start	Soft Start	Soft Start	Soft Start
Dimension	Height	mm	1690	1690	1690	1690	
	Width	mm	990	990	990	990	
	Depth	mm	780	780	780	780	
Weight	kg		228	228	228	228	
Colour			Silky shade (Munsell 1Y8.5/0.5)	Silky shade (Munsell 1Y8.5/0.5)	Silky shade (Munsell 1Y8.5/0.5)	Silky shade (Munsell 1Y8.5/0.5)	
Compressor	Type		Hermetic twin rotary compressor	Hermetic twin rotary compressor	Hermetic twin rotary compressor	Hermetic twin rotary compressor	
	Motor output	kW	5.25	7.93	9.75	14.0	
Fan unit	Type		Propeller fan	Propeller fan	Propeller fan	Propeller fan	
	Motor output	kW	1.0	1.0	1.0	1.0	
	Air volume	m ³ /h	9900	10500	11700	11880	
Max. external static pressure			Pa	80	80	80	
Heat exchanger				Finned tube	Finned tube	Finned tube	
Refrigerant	Name		R410A	R410A	R410A	R410A	
	Charge	Heat pump	kg	6.0	6.0	6.0	
High-pressure switch				OFF:3.2 ON:4.15	OFF:3.2 ON:4.15	OFF:3.2 ON:4.15	
Protective devices				(*3)	(*3)	(*3)	
Power supply wiring	MCA (*4)	A	17.0	23.0	27.0	31.0	
	MOCP (*5)	A	20.0	32.0	32.0	40.0	
Piping connections	Gas	Type		Brazing	Brazing	Brazing	
		Diameter	mm	19.1	22.2	28.6	
	Liquid	Type		Brazing	Brazing	Brazing	
		Diameter	mm	12.7	12.7	12.7	
Max. number of connected indoor units				18	22	27	
Sound pressure level	Cooling	dB(A)	53.0	55.0	58.0	58.0	
	Heating	dB(A)	56.0	58.0	62.0	62.0	
Sound power level	Cooling	dB(A)	75.0	77.0	79.0	79.0	
	Heating	dB(A)	76.0	77.0	81.0	82.0	
Operation temperature range	Cooling(*7)	CDB	-10.0 to 52.0	-10.0 to 52.0	-10.0 to 52.0	-10.0 to 52.0	
	Heating(*6)	CWB	-25.0 to 15.5	-25.0 to 15.5	-25.0 to 15.5	-25.0 to 15.5	

Note

(*1) Rated conditions Cooling : Indoor 27 degC Dry Bulb /19 degC Wet Bulb , Outdoor 35 degC Dry Bulb.
Heating : Indoor 20 degC Dry Bulb, Outdoor 7 degC Dry Bulb / 6 degC WetBulb.
Based on equivalent piping length of 7.5m and piping height difference of 0m.
System combination : SMMS-u outdoor unit + MMU-UP***HP-E indoor units.

(*2) Voltage range : Units are suitable for use on electrical systems where voltage supplied to unit terminal is not below or above listed range limits.

(*3) Discharge temp. sensor / Suction temp. sensor / High-pressure sensor / Low-pressure sensor / Compressor case thermostat / PC board fuse

(*4) Select wire size base on the larger value of MCA.

MCA : Minimum Circuit Amps

(*5) MOCP : Maximum Overcurrent Protection(Amps)

(*6) Low ambient heating (-20degC or less) for extended periods of time is not allowed

(*7) Low ambient cooling (-5 deg C or less) is limited to application.

Model name			MMY-MUP1601HT8P-E	MMY-MUP1801HT8P-E	MMY-MUP2001HT8P-E	MMY-MUP2201HT8P-E	MMY-MUP2401HT8P-E1	
Outdoor unit type			Inverter unit	Inverter unit	Inverter unit	Inverter unit	Inverter unit	
Cooling capacity (*1)	kW		45.0	50.4	56.0	61.5	67.0	
Heating capacity (Rated. *1)	kW		45.0	50.4	56.0	61.5	64.5	
Heating capacity (Max. *1)	kW		50.0	56.0	63.0	69.0	70.0	
Capacity range	HP		16	18	20	22	24	
Power supply			3N~ 50Hz 400V(380-415V)	3N~ 50Hz 400V(380-415V)	3N~ 50Hz 400V(380-415V)	3N~ 50Hz 400V(380-415V)	3N~ 50Hz 400V(380-415V)	
Voltage range (*2)		Minimum	V	342	342	342	342	
		Maximum	V	456	456	456	456	
Electrical characteristic (*1)	Cooling	Running current	A	21.6	24.4	27.7	31.4	
		Power input	kW	14.06	15.90	18.01	20.43	
		EER	kW/kW	3.20	3.17	3.11	3.01	
		SEER		7.71	7.68	7.62	7.23	
	Heating (Rated.)	Running current	A	18.3	19.3	22.9	24.8	
		Power input	kW	11.94	12.54	14.93	16.18	
		COP	kW/kW	3.77	4.02	3.75	3.80	
	Heating (Max.)	Running current	A	21.5	22.7	27.2	29.2	
		Power input	kW	14.01	14.78	17.70	19.01	
		COP	kW/kW	3.57	3.79	3.56	3.63	
	SCOP		4.79	4.75	4.43	4.44		
Starting current	A	Soft Start	Soft Start	Soft Start	Soft Start	Soft Start		
Dimension		Height	mm	1690	1690	1690	1690	
		Width	mm	1290	1290	1290	1290	
		Depth	mm	780	780	780	780	
Weight	Heat pump	kg	312	312	334	356		
Colour			Silky shade (Munsell 1Y8.5/0.5)	Silky shade (Munsell 1Y8.5/0.5)	Silky shade (Munsell 1Y8.5/0.5)	Silky shade (Munsell 1Y8.5/0.5)	Silky shade (Munsell 1Y8.5/0.5)	
Compressor		Type		Hermetic triple rotary compressor	Hermetic triple rotary compressor	Hermetic triple rotary compressor	Hermetic twin rotary compressor	
		Motor output	kW	13.2	14.5	16.9	9.61x2	
Fan unit		Type		Propeller fan	Propeller fan	Propeller fan	Propeller fan	
		Motor output	kW	2.0	2.0	2.0	2.0	
		Air volume	m3/h	15300	16800	15900	16500	
Max. external static pressure			Pa	80	80	80	80	
Heat exchanger				Finned tube	Finned tube	Finned tube	Finned tube	
Refrigerant		Name		R410A	R410A	R410A	R410A	
		Charge	Heat pump	kg	9.0	9.0	9.0	9.0
High-pressure switch				OFF:3.2 ON:4.15	OFF:3.2 ON:4.15	OFF:3.2 ON:4.15	OFF:3.2 ON:4.15	
Protective devices				(*3)	(*3)	(*3)	(*3)	
Power supply wiring		MCA (*4)	A	34.0	38.0	40.0	57.0	
		MOCP (*5)	A	40.0	50.0	50.0	63.0	
Piping connections		Gas	Type		Brazing	Brazing	Brazing	
			Diameter	mm	28.6	28.6	28.6	34.9
		Liquid	Type		Brazing	Brazing	Brazing	Brazing
			Diameter	mm	15.9	15.9	15.9	19.1
Max. number of connected indoor units				36	40	45	49	
Sound pressure level		Cooling	dB(A)	60.0	61.0	63.0	63.0	
		Heating	dB(A)	63.0	67.0	67.0	67.0	
Sound power level		Cooling	dB(A)	83.0	84.0	86.0	86.0	
		Heating	dB(A)	86.0	89.0	90.0	90.0	
Operation temperature range		Cooling(*7)	CDB	-10.0 to 52.0	-10.0 to 52.0	-10.0 to 52.0	-10.0 to 52.0	
		Heating(*6)	CWB	-25.0 to 15.5	-25.0 to 15.5	-25.0 to 15.5	-25.0 to 15.5	

Note

- (*1) Rated conditions Cooling : Indoor 27 degC Dry Bulb / 19 degC Wet Bulb , Outdoor 35 degC Dry Bulb.
Heating : Indoor 20 degC Dry Bulb, Outdoor 7 degC Dry Bulb / 6 degC WetBulb.
Based on equivalent piping length of 7.5m and piping height difference of 0m.
System combination : SMMS-u outdoor unit + MMU-UP***HP-E indoor units.
- (*2) Voltage range : Units are suitable for use on electrical systems where voltage supplied to unit terminal is not below or above listed range limits.
- (*3) Discharge temp. sensor / Suction temp. sensor / High-pressure sensor / Low-pressure sensor / Compressor case thermostat / PC board fuse
- (*4) Select wire size base on the larger value of MCA.
MCA : Minimum Circuit Amps
- (*5) MOCP : Maximum Overcurrent Protection(Amps)
- (*6) Low ambient heating (-20degC or less) for extended periods of time is not allowed
- (*7) Low ambient cooling (-5 deg C or less) is limited to application.

Model	Name			MMY-UP2611HT8P-E	MMY-UP2811HT8P-E	MMY-UP3011HT8P-E	MMY-UP3211HT8P-E
	Combination			MMY-MUP1401HT8P-E	MMY-MUP1401HT8P-E	MMY-MUP1801HT8P-E	MMY-MUP2001HT8P-E
				MMY-MUP1201HT8P-E	MMY-MUP1401HT8P-E	MMY-MUP1201HT8P-E	MMY-MUP1201HT8P-E
Outdoor unit type				Inverter unit	Inverter unit	Inverter unit	Inverter unit
Cooling capacity (*1)		kW	73.5	80.0	83.9	89.5	
Heating capacity (Rated. *1)		kW	73.5	80.0	83.9	89.5	
Heating capacity (Max. *1)		kW	82.5	90.0	93.5	100.5	
Capacity range		HP	26	28	30	32	
Power supply				3N~ 50Hz 400V(380-415V)	3N~ 50Hz 400V(380-415V)	3N~ 50Hz 400V(380-415V)	3N~ 50Hz 400V(380-415V)
Voltage range (*2)		Minimum	V	342	342	342	342
		Maximum	V	456	456	456	456
Electrical characteristic (*1)	Cooling	Running current	A	38.6	45.2	40.4	43.7
		Power input	kW	24.89	29.10	26.24	28.35
		EER	kW/kW	2.95	2.75	3.20	3.16
	Heating (Rated.)	Running current	A	27.6	31.0	31.4	35.0
		Power input	kW	17.77	20.00	20.31	22.70
		COP	kW/kW	4.14	4.00	4.13	3.94
	Heating (Max.)	Running current	A	32.6	37.6	36.5	41.0
		Power input	kW	21.00	24.26	23.65	26.57
		COP	kW/kW	3.93	3.71	3.95	3.78
		SEER		7.17	7.05	7.52	7.50
	SCOP		4.67	4.60	4.75	4.55	
	Starting current	A	Soft Start	Soft Start	Soft Start	Soft Start	
Weight	Heat pump	kg	228 + 228	228 + 228	312 + 228	334 + 228	
Colour				Silky shade (Munsell 1Y8.5/0.5)	Silky shade (Munsell 1Y8.5/0.5)	Silky shade (Munsell 1Y8.5/0.5)	Silky shade (Munsell 1Y8.5/0.5)
Compressor	Type			Hermetic rotary	Hermetic rotary	Hermetic rotary	Hermetic rotary
	Motor output	kW	14.0 + 9.75	14.0 + 14.0	14.5 + 9.75	16.9 + 9.75	
Fan unit	Fan			Propeller fan	Propeller fan	Propeller fan	Propeller fan
	Motor output	kW	1.0 + 1.0	1.0 + 1.0	2.0 + 1.0	2.0 + 1.0	
	Air volume	m ³ /h	11880 + 11700	11880 + 11880	16800 + 11700	15900 + 11700	
Max. external static pressure		Pa	80	80	80	80	
Heat exchanger				Finned tube	Finned tube	Finned tube	Finned tube
Refrigerant	Name			R410A	R410A	R410A	R410A
	Charge	Heat pump	kg	6.0 + 6.0	6.0 + 6.0	9.0 + 6.0	9.0 + 6.0
High-pressure switch				OFF:3.2 ON:4.15	OFF:3.2 ON:4.15	OFF:3.2 ON:4.15	OFF:3.2 ON:4.15
Protective devices				(*3)	(*3)	(*3)	(*3)
Power supply wiring		MCA (*4)	A	31 + 27	31 + 31	38 + 27	40 + 27
		MOCP (*5)	A	40 + 32	40 + 40	50 + 32	50 + 32
Piping connections	Gas	Type		Brazing	Brazing	Brazing	Brazing
		Diameter	mm	34.9	34.9	34.9	34.9
	Liquid	Type		Brazing	Brazing	Brazing	Brazing
		Diameter	mm	19.1	19.1	19.1	19.1
Max. number of connected indoor units				58	63	64	65
Sound pressure level		Cooling	dB(A)	61.5	61.5	63.0	64.5
		Heating	dB(A)	65.5	65.5	68.5	68.5
Sound power level		Cooling	dB(A)	82.5	82.5	85.5	87.0
		Heating	dB(A)	85.0	85.5	90.0	91.0
Operation temperature range		Cooling	CDB	-5.0 to 52.0	-5.0 to 52.0	-5.0 to 52.0	-5.0 to 52.0
		Heating(*6)	CWB	-25.0 to 15.5	-25.0 to 15.5	-25.0 to 15.5	-25.0 to 15.5

Note

(*1) Rated conditions Cooling : Indoor 27 degC Dry Bulb /19 degC Wet Bulb , Outdoor 35 degC Dry Bulb.
 Heating : Indoor 20 degC Dry Bulb, Outdoor 7 degC Dry Bulb / 6 degC WetBulb.
 Based on equivalent piping length of 7.5m and piping height difference of 0m.
 System combination : SMMS-u outdoor unit + MMU-UP***HP-E indoor units.

(*2) Voltage range : Units are suitable for use on electrical systems where voltage supplied to unit terminal is not below or above listed range limits.

(*3) Discharge temp. sensor / Suction temp. sensor / High-pressure sensor / Low-pressure sensor / Compressor case thermostat / PC board fuse

(*4) Select wire size base on the larger value of MCA.

MCA : Minimum Circuit Amps

(*5) MOCP : Maximum Overcurrent Protection(Amps)

(*6) Low ambient heating (-20degC or less) for extended periods of time is not allowed

(*7) Low ambient cooling (-5 deg C or less) is limited to application.

Model	Name		MMY-UP3411HT8P-E	MMY-UP3611HT8P-E	MMY-UP3811HT8P-E	MMY-UP4011HT8P-E
	Combination		MMY-MUP2001HT8P-E	MMY-MUP2401HT8P-E1	MMY-MUP2401HT8P-E1	MMY-MUP2001HT8P-E
			MMY-MUP1401HT8P-E	MMY-MUP1201HT8P-E	MMY-MUP1401HT8P-E	MMY-MUP2001HT8P-E
Outdoor unit type			Inverter unit	Inverter unit	Inverter unit	Inverter unit
Cooling capacity (*1)		kW	96.0	100.5	107.0	112.0
Heating capacity (Rated. *1)		kW	96.0	95.0	101.5	112.0
Heating capacity (Max. *1)		kW	108.0	107.5	115.0	126.0
Capacity range		HP	34	36	38	40
Power supply			3N~ 50Hz 400V(380-415V)	3N~ 50Hz 400V(380-415V)	3N~ 50Hz 400V(380-415V)	3N~ 50Hz 400V(380-415V)
Voltage range (*2)		Minimum	V	342	342	342
		Maximum	V	456	456	456
Electrical characteristic (*1)	Cooling	Running current	A	50.3	53.1	59.7
		Power input	kW	32.56	34.53	38.74
		EER	kW/kW	2.95	2.91	2.76
	Heating (Rated.)	Running current	A	38.4	41.2	44.6
		Power input	kW	24.93	26.75	28.98
		COP	kW/kW	3.85	3.55	3.50
	Heating (Max.)	Running current	A	46.0	45.7	50.7
		Power input	kW	29.83	29.64	32.90
		COP	kW/kW	3.62	3.63	3.50
	SEER			7.38	7.01	6.93
	SCOP			4.50	4.38	4.33
	Starting current		A	Soft Start	Soft Start	Soft Start
Weight	Heat pump	kg	334 + 228	356 + 228	356 + 228	334 + 334
Colour			Silky shade (Munsell 1Y8.5/0.5)	Silky shade (Munsell 1Y8.5/0.5)	Silky shade (Munsell 1Y8.5/0.5)	Silky shade (Munsell 1Y8.5/0.5)
Compressor	Type		Hermetic rotary	Hermetic rotary	Hermetic rotary	Hermetic rotary
	Motor output	kW	16.9 + 14.0	11.4x2 + 9.75	11.4x2 + 14.0	16.9 + 16.9
Fan unit	Fan		Propeller fan	Propeller fan	Propeller fan	Propeller fan
	Motor output	kW	2.0 + 1.0	2.0 + 1.0	2.0 + 1.0	2.0 + 2.0
	Air volume	m3/h	15900 + 11880	16500 + 11700	16500 + 11880	15900 + 15900
Max. external static pressure		Pa	80	80	80	80
Heat exchanger			Finned tube	Finned tube	Finned tube	Finned tube
Refrigerant	Name		R410A	R410A	R410A	R410A
	Charge	Heat pump	kg	9.0 + 6.0	9.0 + 6.0	9.0 + 9.0
High-pressure switch		Pa	OFF:3.2 ON:4.15	OFF:3.2 ON:4.15	OFF:3.2 ON:4.15	OFF:3.2 ON:4.15
Protective devices			(*3)	(*3)	(*3)	(*3)
Power supply wiring	MCA (*4)	A	40 + 31	60 + 27	60 + 31	40 + 40
	MOCP (*5)	A	50 + 40	80 + 32	80 + 40	50 + 50
Piping connections	Gas	Type	Brazing	Brazing	Brazing	Brazing
		Diameter	mm	34.9	41.3	41.3
	Liquid	Type	Brazing	Brazing	Brazing	Brazing
		Diameter	mm	19.1	22.2	22.2
Max. number of connected indoor units			66	67	68	69
Sound pressure level	Cooling	dB(A)	64.5	64.5	64.5	
	Heating	dB(A)	68.5	68.5	68.5	
Sound power level	Cooling	dB(A)	87.0	87.0	87.0	
	Heating	dB(A)	91.0	91.0	91.0	
Operation temperature range	Cooling	CDB	-5.0 to 52.0	-5.0 to 52.0	-5.0 to 52.0	
	Heating(*6)	CWB	-25.0 to 15.5	-25.0 to 15.5	-25.0 to 15.5	

Note

(*1) Rated conditions Cooling : Indoor 27 degC Dry Bulb /19 degC Wet Bulb , Outdoor 35 degC Dry Bulb.
 Heating : Indoor 20 degC Dry Bulb, Outdoor 7 degC Dry Bulb / 6 degC WetBulb.
 Based on equivalent piping length of 7.5m and piping height difference of 0m.
 System combination : SMMS-u outdoor unit + MMU-UP***HP-E indoor units.

(*2) Voltage range : Units are suitable for use on electrical systems where voltage supplied to unit terminal is not below or above listed range limits.

(*3) Discharge temp. sensor / Suction temp. sensor / High-pressure sensor / Low-pressure sensor / Compressor case thermostat / PC board fuse

(*4) Select wire size base on the larger value of MCA.

MCA : Minimum Circuit Amps

(*5) MOCP : Maximum Overcurrent Protection(Amps)

(*6) Low ambient heating (-20degC or less) for extended periods of time is not allowed

(*7) Low ambient cooling (-5 deg C or less) is limited to application.

Model	Name		MMY-UP4211HT8P-E	MMY-UP4411HT8P-E	MMY-UP4611HT8P-E	MMY-UP4811HT8P-E
	Combination		MMY-MUP2401HT8P-E1 MMY-MUP1801HT8P-E	MMY-MUP2401HT8P-E1 MMY-MUP2001HT8P-E	MMY-MUP2401HT8P-E1 MMY-MUP2201HT8P-E	MMY-MUP2401HT8P-E1 MMY-MUP2401HT8P-E1
Outdoor unit type			Inverter unit	Inverter unit	Inverter unit	Inverter unit
Cooling capacity (*1)		kW	117.4	123.0	128.5	134.0
Heating capacity (Rated. *1)		kW	111.9	117.5	123.0	123.0
Heating capacity (Max. *1)		kW	126.0	133.0	139.0	140.0
Capacity range		HP	42	44	46	48
Power supply			3N~ 50Hz 400V(380-415V)	3N~ 50Hz 400V(380-415V)	3N~ 50Hz 400V(380-415V)	3N~ 50Hz 400V(380-415V)
Voltage range (*2)		Minimum	V	342	342	342
		Maximum	V	456	456	456
Electrical characteristic (*1)	Cooling	Running current	A	61.5	64.8	68.5
		Power input	kW	40.09	42.20	44.62
		EER	kW/kW	2.93	2.91	2.88
	Heating (Rated.)	Running current	A	48.4	52.0	53.9
		Power input	kW	31.52	33.91	35.16
		COP	kW/kW	3.55	3.47	3.50
	Heating (Max.)	Running current	A	54.6	59.1	61.1
		Power input	kW	35.55	38.47	39.78
		COP	kW/kW	3.54	3.46	3.49
	SEER			7.22	7.21	7.04
	SCOP			4.43	4.30	4.31
Starting current		A	Soft Start	Soft Start	Soft Start	
Weight	Heat pump	kg	356 + 312	356 + 334	356 + 356	356 + 356
Colour			Silky shade (Munsell 1Y8.5/0.5)	Silky shade (Munsell 1Y8.5/0.5)	Silky shade (Munsell 1Y8.5/0.5)	Silky shade (Munsell 1Y8.5/0.5)
Compressor	Type		Hermetic rotary	Hermetic rotary	Hermetic rotary	Hermetic rotary
	Motor output	kW	11.4x2 + 14.5	11.4x2 + 16.9	11.4x2 + 9.61x2	11.4x2 + 11.4x2
Fan unit	Fan		Propeller fan	Propeller fan	Propeller fan	Propeller fan
	Motor output	kW	2.0 + 2.0	2.0 + 2.0	2.0 + 2.0	2.0 + 2.0
	Air volume	m3/h	16500 + 16800	16500 + 15900	16500 + 16500	16500 + 16500
Max. external static pressure		Pa	80	80	80	80
Heat exchanger			Finned tube	Finned tube	Finned tube	Finned tube
Refrigerant	Name		R410A	R410A	R410A	R410A
	Charge	Heat pump	kg	9.0 + 9.0	9.0 + 9.0	9.0 + 9.0
High-pressure switch		Pa	OFF:3.2 ON:4.15	OFF:3.2 ON:4.16	OFF:3.2 ON:4.17	OFF:3.2 ON:4.17
Protective devices			(*3)	(*3)	(*3)	(*3)
Power supply wiring		MCA (*4)	A	60 + 38	60 + 40	60 + 57
		MOCP (*5)	A	80 + 50	80 + 50	80 + 63
Piping connections	Gas	Type	Brazing	Brazing	Brazing	Brazing
		Diameter	mm	41.3	41.3	41.3
	Liquid	Type	Brazing	Brazing	Brazing	Brazing
		Diameter	mm	22.2	22.2	22.2
Max. number of connected indoor units			70	71	72	73
Sound pressure level		Cooling	dB(A)	65.5	66.5	66.5
		Heating	dB(A)	70.5	70.5	70.5
Sound power level		Cooling	dB(A)	88.5	89.5	89.5
		Heating	dB(A)	93.0	93.5	93.5
Operation temperature range		Cooling	CDB	-5.0 to 52.0	-5.0 to 52.0	-5.0 to 52.0
		Heating(*6)	CWB	-25.0 to 15.5	-25.0 to 15.5	-25.0 to 15.5

Note
 (*1) Rated conditions Cooling : Indoor 27 degC Dry Bulb /19 degC Wet Bulb , Outdoor 35 degC Dry Bulb.
 Heating : Indoor 20 degC Dry Bulb, Outdoor 7 degC Dry Bulb / 6 degC WetBulb.
 Based on equivalent piping length of 7.5m and piping height difference of 0m.
 System combination : SMMS-u outdoor unit + MMU-UP***HP-E indoor units.
 (*2) Voltage range : Units are suitable for use on electrical systems where voltage supplied to unit terminal is not below or above listed range limits.
 (*3) Discharge temp. sensor / Suction temp. sensor / High-pressure sensor / Low-pressure sensor / Compressor case thermostat / PC board fuse
 (*4) Select wire size base on the larger value of MCA.
 MCA : Minimum Circuit Amps
 (*5) MOCP : Maximum Overcurrent Protection(Amps)
 (*6) Low ambient heating (-20degC or less) for extended periods of time is not allowed
 (*7) Low ambient cooling (-5 deg C or less) is limited to application.

Model	Name			MMY-UP5011HT8P-E	MMY-UP5211HT8P-E	MMY-UP5411HT8P-E
	Combination			MMY-MUP2401HT8P-E1	MMY-MUP2401HT8P-E1	MMY-MUP2001HT8P-E
				MMY-MUP1401HT8P-E	MMY-MUP1401HT8P-E	MMY-MUP2001HT8P-E
				MMY-MUP1201HT8P-E	MMY-MUP1401HT8P-E	MMY-MUP1401HT8P-E
Outdoor unit type				Inverter unit	Inverter unit	Inverter unit
Cooling capacity (*1)		kW	140.5	147.0	152.0	
Heating capacity (Rated. *1)		kW	135.0	141.5	152.0	
Heating capacity (Max. *1)		kW	152.5	160.0	171.0	
Capacity range		HP	50	52	54	
Power supply				3N~ 50Hz 400V(380-415V)	3N~ 50Hz 400V(380-415V)	3N~ 50Hz 400V(380-415V)
Voltage range (*2)		Minimum	V	342	342	
		Maximum	V	456	456	
Electrical characteristic (*1)	Cooling	Running current	A	75.7	82.3	
		Power input	kW	49.08	53.29	
		EER	kW/kW	2.86	2.76	
	Heating (Rated.)	Running current	A	56.7	60.1	
		Power input	kW	36.75	38.98	
		COP	kW/kW	3.67	3.63	
	Heating (Max.)	Running current	A	64.5	69.5	
		Power input	kW	41.77	45.03	
		COP	kW/kW	3.65	3.55	
	SEER			7.02	6.96	7.49
SCOP			4.44	4.41	4.47	
Starting current		A	Soft Start	Soft Start	Soft Start	
Weight	Heat pump	kg	356 + 228 + 228	356 + 228 + 228	334 + 334 + 228	
Colour				Silky shade (Munsell 1Y8.5/0.5)	Silky shade (Munsell 1Y8.5/0.5)	Silky shade (Munsell 1Y8.5/0.5)
Compressor	Type			Hermetic rotary compressor	Hermetic rotary compressor	Hermetic rotary compressor
	Motor output	kW	11.4x2 + 14.0 + 9.75	11.4x2 + 14.0 + 14.0	16.9 + 16.9 + 14.0	
Fan unit	Fan			Propeller fan	Propeller fan	Propeller fan
	Motor output	kW	2.0 + 1.0 + 1.0	2.0 + 1.0 + 1.0	2.0 + 2.0 + 1.0	
	Air volume	m3/h	16500 + 11880 + 11700	16500 + 11880 + 11880	15900 + 15900 + 11880	
Max. external static pressure		Pa	80	80	80	
Heat exchanger				Finned tube	Finned tube	Finned tube
Refrigerant	Name			R410A	R410A	R410A
	Charge	Heat pump	kg	9.0 + 6.0 + 6.0	9.0 + 6.0 + 6.0	9.0 + 9.0 + 6.0
High-pressure switch		Pa	OFF:3.2 ON:4.15	OFF:3.2 ON:4.15	OFF:3.2 ON:4.15	
Protective devices				(*3)	(*3)	(*3)
Power supply wiring		MCA (*4)	A	60 + 31 + 27	60 + 31 + 31	40 + 40 + 31
		MOCP (*5)	A	80 + 40 + 32	80 + 40 + 40	50 + 50 + 40
Piping connections	Gas	Type		Brazing	Brazing	Brazing
		Diameter	mm	41.3	41.3	41.3
	Liquid	Type		Brazing	Brazing	Brazing
		Diameter	mm	22.2	22.2	22.2
Max. number of connected indoor units				74	75	76
Sound pressure level		Cooling	dB(A)	65.5	65.5	67.0
		Heating	dB(A)	69.5	69.5	71.0
Sound power level		Cooling	dB(A)	87.5	87.5	89.5
		Heating	dB(A)	91.5	91.5	93.5
Operation temperature range		Cooling	CDB	-5.0 to 52.0	-5.0 to 52.0	-5.0 to 52.0
		Heating(*6)	CWB	-25.0 to 15.5	-25.0 to 15.5	-25.0 to 15.5

Note

- (*1) Rated conditions Cooling : Indoor 27 degC Dry Bulb /19 degC Wet Bulb , Outdoor 35 degC Dry Bulb.
Heating : Indoor 20 degC Dry Bulb, Outdoor 7 degC Dry Bulb / 6 degC WetBulb.
Based on equivalent piping length of 7.5m and piping height difference of 0m.
System combination : SMMS-u outdoor unit + MMU-UP***HP-E indoor units.
- (*2) Voltage range : Units are suitable for use on electrical systems where voltage supplied to unit terminal is not below or above listed range limits.
- (*3) Discharge temp. sensor / Suction temp. sensor / High-pressure sensor / Low-pressure sensor / Compressor case thermostat / PC board fuse
- (*4) Select wire size base on the larger value of MCA.
MCA : Minimum Circuit Amps
- (*5) MOCP : Maximum Overcurrent Protection(Amps)
- (*6) Low ambient heating (-20degC or less) for extended periods of time is not allowed
- (*7) Low ambient cooling (-5 deg C or less) is limited to application.

Model	Name		MMY-UP5611HT8P-E	MMY-UP5811HT8P-E	MMY-UP6011HT8P-E
	Combination		MMY-MUP2401HT8P-E1	MMY-MUP2401HT8P-E1	MMY-MUP2401HT8P-E1
			MMY-MUP2001HT8P-E	MMY-MUP2001HT8P-E	MMY-MUP2401HT8P-E1
			MMY-MUP1201HT8P-E	MMY-MUP1401HT8P-E	MMY-MUP1201HT8P-E
Outdoor unit type			Inverter unit	Inverter unit	Inverter unit
Cooling capacity (*1)		kW	156.5	163.0	167.5
Heating capacity (Rated. *1)		kW	151.0	157.5	156.5
Heating capacity (Max. *1)		kW	170.5	178.0	177.5
Capacity range		HP	56	58	60
Power supply			3N~ 50Hz 400V(380-415V)	3N~ 50Hz 400V(380-415V)	3N~ 50Hz 400V(380-415V)
Voltage range (*2)		Minimum	V	342	342
		Maximum	V	456	456
Electrical characteristic (*1)	Cooling	Running current	A	80.8	87.4
		Power input	kW	52.54	56.75
		EER	kW/kW	2.98	2.87
	Heating (Rated.)	Running current	A	64.1	67.5
		Power input	kW	41.68	43.91
		COP	kW/kW	3.62	3.59
	Heating (Max.)	Running current	A	72.9	77.9
		Power input	kW	47.34	50.60
		COP	kW/kW	3.60	3.52
	SEER			7.23	7.19
SCOP			4.41	4.37	
Starting current		A	Soft Start	Soft Start	
Weight	Heat pump	kg	356 + 334 + 228	356 + 334 + 228	356 + 356 + 228
Colour			Silky shade (Munsell 1Y8.5/0.5)	Silky shade (Munsell 1Y8.5/0.5)	Silky shade (Munsell 1Y8.5/0.5)
Compressor	Type		Hermetic rotary compressor	Hermetic rotary compressor	Hermetic rotary compressor
	Motor output	kW	11.4x2 + 16.9 + 9.75	11.4x2 + 16.9 + 14.0	11.4x2 + 11.4x2 + 9.75
Fan unit	Fan		Propeller fan	Propeller fan	Propeller fan
	Motor output	kW	2.0 + 2.0 + 1.0	2.0 + 2.0 + 1.0	2.0 + 2.0 + 1.0
	Air volume	m3/h	16500 + 15900 + 11700	16500 + 15900 + 11880	16500 + 16500 + 11700
Max. external static pressure		Pa	80	80	80
Heat exchanger			Finned tube	Finned tube	Finned tube
Refrigerant	Name		R410A	R410A	R410A
	Charge	Heat pump	kg	9.0 + 9.0 + 6.0	9.0 + 9.0 + 6.0
High-pressure switch		Pa	OFF:3.2 ON:4.15	OFF:3.2 ON:4.15	OFF:3.2 ON:4.15
Protective devices			(*3)	(*3)	(*3)
Power supply wiring		MCA (*4)	A	60 + 40 + 27	60 + 60 + 27
		MOCP (*5)	A	80 + 50 + 32	80 + 50 + 40
Piping connections	Gas	Type		Brazing	Brazing
		Diameter	mm	41.3	41.3
	Liquid	Type		Brazing	Brazing
		Diameter	mm	22.2	22.2
Max. number of connected indoor units			77	78	79
Sound pressure level		Cooling	dB(A)	67.0	67.0
		Heating	dB(A)	71.0	71.0
Sound power level		Cooling	dB(A)	89.5	89.5
		Heating	dB(A)	93.5	93.5
Operation temperature range		Cooling	CDB	-5.0 to 52.0	-5.0 to 52.0
		Heating(*6)	CWB	-25.0 to 15.5	-25.0 to 15.5

Note

- (*1) Rated conditions Cooling : Indoor 27 degC Dry Bulb /19 degC Wet Bulb , Outdoor 35 degC Dry Bulb.
Heating : Indoor 20 degC Dry Bulb, Outdoor 7 degC Dry Bulb / 6 degC WetBulb.
Based on equivalent piping length of 7.5m and piping height difference of 0m.
System combination : SMMS-u outdoor unit + MMU-UP***HP-E indoor units.
- (*2) Voltage range : Units are suitable for use on electrical systems where voltage supplied to unit terminal is not below or above listed range limits.
- (*3) Discharge temp. sensor / Suction temp. sensor / High-pressure sensor / Low-pressure sensor / Compressor case thermostat / PC board fuse
- (*4) Select wire size base on the larger value of MCA.
MCA : Minimum Circuit Amps
- (*5) MOCP : Maximum Overcurrent Protection(Amps)
- (*6) Low ambient heating (-20degC or less) for extended periods of time is not allowed
- (*7) Low ambient cooling (-5 deg C or less) is limited to application.

Model	Name		MMY-UP6211HT8P-E	MMY-UP6411HT8P-E	MMY-UP6611HT8P-E
	Combination		MMY-MUP2401HT8P-E1	MMY-MUP2401HT8P-E1	MMY-MUP2401HT8P-E1
			MMY-MUP2401HT8P-E1	MMY-MUP2001HT8P-E	MMY-MUP2201HT8P-E
			MMY-MUP1401HT8P-E	MMY-MUP2001HT8P-E	MMY-MUP2001HT8P-E
Outdoor unit type			Inverter unit	Inverter unit	Inverter unit
Cooling capacity (*1)		kW	174.0	179.0	184.5
Heating capacity (Rated. *1)		kW	163.0	173.5	179.0
Heating capacity (Max. *1)		kW	185.0	196.0	202.0
Capacity range		HP	62	64	66
Power supply			3N~ 50Hz 400V(380-415V)	3N~ 50Hz 400V(380-415V)	3N~ 50Hz 400V(380-415V)
Voltage range (*2)		Minimum	V	342	342
		Maximum	V	456	456
Electrical characteristic (*1)	Cooling	Running current	A	96.8	92.5
		Power input	kW	62.93	60.21
		EER	kW/kW	2.76	2.97
	Heating (Rated.)	Running current	A	73.7	74.9
		Power input	kW	47.96	48.84
		COP	kW/kW	3.40	3.55
	Heating (Max.)	Running current	A	82.6	86.3
		Power input	kW	53.67	56.17
		COP	kW/kW	3.45	3.49
	SEER			6.92	7.34
SCOP			4.27	4.34	
Starting current		A	Soft Start	Soft Start	
Weight	Heat pump	kg	356 + 356 + 228	356 + 334 + 334	356 + 356 + 334
Colour			Silky shade (Munsell 1Y8.5/0.5)	Silky shade (Munsell 1Y8.5/0.5)	Silky shade (Munsell 1Y8.5/0.5)
Compressor	Type		Hermetic rotary compressor	Hermetic rotary compressor	Hermetic rotary compressor
	Motor output	kW	11.4x2 + 11.4x2 + 14.0	11.4x2 + 16.9 + 16.9	11.4x2 + 9.61x2 + 16.9
Fan unit	Fan		Propeller fan	Propeller fan	Propeller fan
	Motor output	kW	2.0 + 2.0 + 1.0	2.0 + 2.0 + 2.0	2.0 + 2.0 + 2.0
	Air volume	m3/h	16500 + 16500 + 11880	16500 + 15900 + 15900	16500 + 16500 + 15900
Max. external static pressure		Pa	80	80	80
Heat exchanger			Finned tube	Finned tube	Finned tube
Refrigerant	Name		R410A	R410A	R410A
	Charge	Heat pump	kg	9.0 + 9.0 + 6.0	9.0 + 9.0 + 9.0
High-pressure switch		Pa	OFF:3.2 ON:4.15	OFF:3.2 ON:4.15	OFF:3.2 ON:4.15
Protective devices			(*3)	(*3)	(*3)
Power supply wiring		MCA (*4)	A	60 + 60 + 31	60 + 40 + 40
		MOCP (*5)	A	80 + 80 + 40	80 + 50 + 50
Piping connections	Gas	Type		Brazing	Brazing
		Diameter	mm	54.0	54.0
	Liquid	Type		Brazing	Brazing
		Diameter	mm	22.2	22.2
Max. number of connected indoor units			80	81	82
Sound pressure level		Cooling	dB(A)	67.0	68.0
		Heating	dB(A)	71.0	72.0
Sound power level		Cooling	dB(A)	89.5	91.0
		Heating	dB(A)	93.5	95.0
Operation temperature range		Cooling	CDB	-5.0 to 52.0	-5.0 to 52.0
		Heating(*6)	CWB	-25.0 to 15.5	-25.0 to 15.5

Note

(*1) Rated conditions Cooling : Indoor 27 degC Dry Bulb /19 degC Wet Bulb , Outdoor 35 degC Dry Bulb.
 Heating : Indoor 20 degC Dry Bulb, Outdoor 7 degC Dry Bulb / 6 degC WetBulb.
 Based on equivalent piping length of 7.5m and piping height difference of 0m.
 System combination : SMMS-u outdoor unit + MMU-UP***HP-E indoor units.

(*2) Voltage range : Units are suitable for use on electrical systems where voltage supplied to unit terminal is not below or above listed range limits.

(*3) Discharge temp. sensor / Suction temp. sensor / High-pressure sensor / Low-pressure sensor / Compressor case thermostat / PC board fuse

(*4) Select wire size base on the larger value of MCA.

MCA : Minimum Circuit Amps

(*5) MOCP : Maximum Overcurrent Protection(Amps)

(*6) Low ambient heating (-20degC or less) for extended periods of time is not allowed

(*7) Low ambient cooling (-5 deg C or less) is limited to application.

Model	Name			MMY-UP6811HT8P-E	MMY-UP7011HT8P-E	MMY-UP7211HT8P-E
	Combination			MMY-MUP2401HT8P-E1	MMY-MUP2401HT8P-E1	MMY-MUP2401HT8P-E1
				MMY-MUP2401HT8P-E1	MMY-MUP2401HT8P-E1	MMY-MUP2401HT8P-E1
				MMY-MUP2001HT8P-E	MMY-MUP2201HT8P-E	MMY-MUP2401HT8P-E1
Outdoor unit type				Inverter unit	Inverter unit	Inverter unit
Cooling capacity (*1)		kW	190.0	195.5	201.0	
Heating capacity (Rated. *1)		kW	179.0	184.5	184.5	
Heating capacity (Max. *1)		kW	203.0	209.0	210.0	
Capacity range		HP	68	70	72	
Power supply				3N~ 50Hz 400V(380-415V)	3N~ 50Hz 400V(380-415V)	3N~ 50Hz 400V(380-415V)
Voltage range (*2)		Minimum	V	342	342	342
		Maximum	V	456	456	456
Electrical characteristic (*1)	Cooling	Running current	A	101.9	105.6	111.3
		Power input	kW	66.39	68.81	72.57
		EER	kW/kW	2.86	2.84	2.77
	Heating (Rated.)	Running current	A	81.1	83.0	87.3
		Power input	kW	52.89	54.14	56.94
		COP	kW/kW	3.38	3.41	3.24
	Heating (Max.)	Running current	A	91.0	93.0	95.7
		Power input	kW	59.24	60.55	62.31
		COP	kW/kW	3.43	3.45	3.37
	SEER			7.09	6.98	6.87
SCOP			4.26	4.26	4.17	
Starting current		A	Soft Start	Soft Start	Soft Start	
Weight	Heat pump	kg	356 + 356 + 334	356 + 356 + 356	356 + 356 + 356	
Colour				Silky shade (Munsell 1Y8.5/0.5)	Silky shade (Munsell 1Y8.5/0.5)	Silky shade (Munsell 1Y8.5/0.5)
Compressor	Type			Hermetic rotary compressor	Hermetic rotary compressor	Hermetic rotary compressor
	Motor output	kW	11.4x2 + 11.4x2 + 16.9	11.4x2 + 11.4x2 + 9.61x2	11.4x2 + 11.4x2 + 11.4x2	
Fan unit	Fan			Propeller fan	Propeller fan	Propeller fan
	Motor output	kW	2.0 + 2.0 + 2.0	2.0 + 2.0 + 2.0	2.0 + 2.0 + 2.0	
	Air volume	m3/h	16500 + 16500 + 15900	16500 + 16500 + 16500	16500 + 16500 + 16500	
Max. external static pressure		Pa	80	80	80	
Heat exchanger				Finned tube	Finned tube	Finned tube
Refrigerant	Name			R410A	R410A	R410A
	Charge	Heat pump	kg	9.0 + 9.0 + 9.0	9.0 + 9.0 + 9.0	9.0 + 9.0 + 9.0
High-pressure switch		Pa	OFF:3.2 ON:4.15	OFF:3.2 ON:4.15	OFF:3.2 ON:4.15	
Protective devices				(*3)	(*3)	(*3)
Power supply wiring		MCA (*4)	A	60 + 60 +40	60 + 60 +57	60 + 60 +60
		MOCP (*5)	A	80 + 80 +50	80 + 80 +63	80 + 80 +80
Piping connections	Gas	Type		Brazing	Brazing	Brazing
		Diameter	mm	54.0	54.0	54.0
	Liquid	Type		Brazing	Brazing	Brazing
		Diameter	mm	22.2	22.2	22.2
Max. number of connected indoor units				83	84	85
Sound pressure level		Cooling	dB(A)	68.0	68.0	68.0
		Heating	dB(A)	72.0	72.0	72.0
Sound power level		Cooling	dB(A)	91.0	91.0	91.0
		Heating	dB(A)	95.0	95.0	95.0
Operation temperature range		Cooling	CDB	-5.0 to 52.0	-5.0 to 52.0	-5.0 to 52.0
		Heating(*6)	CWB	-25.0 to 15.5	-25.0 to 15.5	-25.0 to 15.5

Note

(*1) Rated conditions Cooling : Indoor 27 degC Dry Bulb /19 degC Wet Bulb , Outdoor 35 degC Dry Bulb.
 Heating : Indoor 20 degC Dry Bulb, Outdoor 7 degC Dry Bulb / 6 degC WetBulb.
 Based on equivalent piping length of 7.5m and piping height difference of 0m.
 System combination : SMMS-u outdoor unit + MMU-UP***HP-E indoor units.

(*2) Voltage range : Units are suitable for use on electrical systems where voltage supplied to unit terminal is not below or above listed range limits.

(*3) Discharge temp. sensor / Suction temp. sensor / High-pressure sensor / Low-pressure sensor / Compressor case thermostat / PC board fuse

(*4) Select wire size base on the larger value of MCA.

MCA : Minimum Circuit Amps

(*5) MOCP : Maximum Overcurrent Protection(Amps)

(*6) Low ambient heating (-20degC or less) for extended periods of time is not allowed

(*7) Low ambient cooling (-5 deg C or less) is limited to application.

Model	Name		MMY-UP7411HT8P-E	MMY-UP7611HT8P-E	MMY-UP7811HT8P-E
	Combination		MMY-MUP2401HT8P-E1	MMY-MUP2401HT8P-E1	MMY-MUP2401HT8P-E1
			MMY-MUP2401HT8P-E1	MMY-MUP2401HT8P-E1	MMY-MUP2001HT8P-E
			MMY-MUP1401HT8P-E	MMY-MUP1401HT8P-E	MMY-MUP2001HT8P-E
Outdoor unit type			Inverter unit	Inverter unit	Inverter unit
Cooling capacity (*1)		kW	207.5	214.0	219.0
Heating capacity (Rated. *1)		kW	196.5	203.0	213.5
Heating capacity (Max. *1)		kW	222.5	230.0	241.0
Capacity range		HP	74	76	78
Power supply			3N~ 50Hz 400V(380-415V)	3N~ 50Hz 400V(380-415V)	3N~ 50Hz 400V(380-415V)
Voltage range (*2)		Minimum	V	342	342
		Maximum	V	456	456
Electrical characteristic (*1)	Cooling	Running current	A	112.8	119.4
		Power input	kW	73.27	77.48
		EER	kW/kW	2.83	2.76
	Heating (Rated.)	Running current	A	85.8	89.2
		Power input	kW	55.73	57.96
		COP	kW/kW	3.53	3.50
	Heating (Max.)	Running current	A	96.4	101.4
		Power input	kW	62.54	65.80
		COP	kW/kW	3.56	3.50
	SEER			6.97	6.93
	SCOP			4.36	4.33
	Starting current		A	Soft Start	Soft Start
Weight	Heat pump	kg	356 + 356 + 228 + 228	356 + 356 + 228 + 228	356 + 334 + 334 + 228
Colour			Silky shade (Munsell 1Y8.5/0.5)	Silky shade (Munsell 1Y8.5/0.5)	Silky shade (Munsell 1Y8.5/0.5)
Compressor	Type	Hermetic rotary compressor			Hermetic rotary compressor
	Motor output	kW	11.4x2 + 11.4x2 + 14.0 + 9.75	11.4x2 + 11.4x2 + 14.0 + 14.0	11.4x2 + 16.9 + 16.9 + 14.0
Fan unit	Fan	Propeller fan			Propeller fan
	Motor output	kW	2.0 + 2.0 + 1.0 + 1.0	2.0 + 2.0 + 1.0 + 1.0	2.0 + 2.0 + 2.0 + 1.0
	Air volume	m ³ /h	16500 + 16500 + 11880 + 11700	16500 + 16500 + 11880 + 11880	16500 + 15900 + 15900 + 11880
Max. external static pressure		Pa	80	80	80
Heat exchanger			Finned tube	Finned tube	Finned tube
Refrigerant	Name	R410A			R410A
	Charge	Heat pump	kg	9.0 + 9.0 + 6.0 + 6.0	9.0 + 9.0 + 6.0 + 6.0
High-pressure switch		Pa	OFF:3.2 ON:4.15	OFF:3.2 ON:4.15	OFF:3.2 ON:4.15
Protective devices			(*3)	(*3)	(*3)
Power supply wiring		MCA (*4)	A	60 + 60 + 31 + 27	60 + 60 + 31 + 31
		MOCP (*5)	A	80 + 80 + 40 + 32	80 + 80 + 40 + 40
Piping connections	Gas	Type	Brazing		
		Diameter	mm	54.0	54.0
	Liquid	Type	Brazing		
		Diameter	mm	22.2	22.2
Max. number of connected indoor units			86	87	88
Sound pressure level		Cooling	dB(A)	67.5	68.5
		Heating	dB(A)	71.5	72.5
Sound power level		Cooling	dB(A)	90.0	91.5
		Heating	dB(A)	94.0	95.0
Operation temperature range		Cooling	CDB	-5.0 to 52.0	-5.0 to 52.0
		Heating(*6)	CWB	-25.0 to 15.5	-25.0 to 15.5

Note

- (*1) Rated conditions Cooling : Indoor 27 degC Dry Bulb /19 degC Wet Bulb , Outdoor 35 degC Dry Bulb.
Heating : Indoor 20 degC Dry Bulb, Outdoor 7 degC Dry Bulb / 6 degC WetBulb.
Based on equivalent piping length of 7.5m and piping height difference of 0m.
System combination : SMMS-u outdoor unit + MMU-UP***HP-E indoor units.
- (*2) Voltage range : Units are suitable for use on electrical systems where voltage supplied to unit terminal is not below or above listed range limits.
- (*3) Discharge temp. sensor / Suction temp. sensor / High-pressure sensor / Low-pressure sensor / Compressor case thermostat / PC board fuse
- (*4) Select wire size base on the larger value of MCA.
MCA : Minimum Circuit Amps
- (*5) MOCP : Maximum Overcurrent Protection(Amps)
- (*6) Low ambient heating (-20degC or less) for extended periods of time is not allowed
- (*7) Low ambient cooling (-5 deg C or less) is limited to application.

Model	Name		MMY-UP8011HT8P-E	MMY-UP8211HT8P-E	MMY-UP8411HT8P-E
	Combination		MMY-MUP2401HT8P-E1	MMY-MUP2401HT8P-E1	MMY-MUP2401HT8P-E1
			MMY-MUP2401HT8P-E1	MMY-MUP2401HT8P-E1	MMY-MUP2401HT8P-E1
			MMY-MUP2001HT8P-E	MMY-MUP2001HT8P-E	MMY-MUP2401HT8P-E1
			MMY-MUP1201HT8P-E	MMY-MUP1401HT8P-E	MMY-MUP1201HT8P-E
Outdoor unit type			Inverter unit	Inverter unit	Inverter unit
Cooling capacity (*1)		kW	223.5	230.0	234.5
Heating capacity (Rated.*1)		kW	212.5	219.0	218.0
Heating capacity (Max.*1)		kW	240.5	248.0	247.5
Capacity range		HP	80	82	84
Power supply			3N~ 50Hz 400V(380-415V)	3N~ 50Hz 400V(380-415V)	3N~ 50Hz 400V(380-415V)
Voltage range (*2)		Minimum	V	342	342
		Maximum	V	456	456
Electrical characteristic (*1)	Cooling	Running current	A	117.9	124.5
		Power input	kW	76.73	80.94
		EER	kW/kW	2.91	2.84
	Heating (Rated.)	Running current	A	93.2	96.6
		Power input	kW	60.66	62.89
		COP	kW/kW	3.50	3.48
	Heating (Max.)	Running current	A	104.8	109.8
		Power input	kW	68.11	71.37
		COP	kW/kW	3.53	3.47
	SEER				7.14
SCOP				4.34	4.32
Starting current		A	Soft Start		
Weight	Heat pump	kg	356 + 356 + 334 + 228	356 + 356 + 334 + 228	356 + 356 + 356 + 228
Colour			Silky shade (Munsell 1Y8.5/0.5)		
Compressor	Type	Hermetic rotary compressor			
	Motor output	kW	11.4x2 + 11.4x2 + 16.9 + 9.75	11.4x2 + 11.4x2 + 16.9 + 14.0	11.4x2 + 11.4x2 + 11.4x2 + 9.75
Fan unit	Fan	Propeller fan			
	Motor output	kW	2.0 + 2.0 + 2.0 + 1.0	2.0 + 2.0 + 2.0 + 1.0	2.0 + 2.0 + 2.0 + 1.0
	Air volume	m ³ /h	16500 + 16500 + 15900 + 11700	16500 + 16500 + 15900 + 11880	16500 + 16500 + 16500 + 11700
Max. external static pressure		Pa	80		
Heat exchanger			Finned tube		
Refrigerant	Name	R410A			
	Charge	Heat pump	kg	9.0 + 9.0 + 9.0 + 6.0	9.0 + 9.0 + 9.0 + 6.0
High-pressure switch		Pa	OFF:3.2 ON:4.15		
Protective devices			(*3)		
Power supply wiring		MCA (*4)	A	60 + 60 + 40 + 27	60 + 60 + 40 + 31
		MOCP (*5)	A	80 + 80 + 50 + 32	80 + 80 + 50 + 40
Piping connections	Gas	Type	Brazing		
		Diameter	mm	54.0	
	Liquid	Type	Brazing		
		Diameter	mm	22.2	
Max. number of connected indoor units			90		
Sound pressure level		Cooling	dB(A)	68.5	
		Heating	dB(A)	72.5	
Sound power level		Cooling	dB(A)	91.5	
		Heating	dB(A)	95.0	
Operation temperature range		Cooling	CDB	-5.0 to 52.0	
		Heating(*6)	CWB	-25.0 to 15.5	

Note
 (*1) Rated conditions Cooling : Indoor 27 degC Dry Bulb /19 degC Wet Bulb , Outdoor 35 degC Dry Bulb.
 Heating : Indoor 20 degC Dry Bulb, Outdoor 7 degC Dry Bulb / 6 degC WetBulb.
 Based on equivalent piping length of 7.5m and piping height difference of 0m.
 System combination : SMMS-u outdoor unit + MMU-UP***HP-E indoor units.
 (*2) Voltage range : Units are suitable for use on electrical systems where voltage supplied to unit terminal is not below or above listed range limits.
 (*3) Discharge temp. sensor / Suction temp. sensor / High-pressure sensor / Low-pressure sensor / Compressor case thermostat / PC board fuse
 (*4) Select wire size base on the larger value of MCA.
 MCA : Minimum Circuit Amps
 (*5) MOCP : Maximum Overcurrent Protection(Amps)
 (*6) Low ambient heating (-20degC or less) for extended periods of time is not allowed
 (*7) Low ambient cooling (-5 deg C or less) is limited to application.

Model	Name		MMY-UP8611HT8P-E	MMY-UP8811HT8P-E	MMY-UP9011HT8P-E	
	Combination		MMY-MUP2401HT8P-E1	MMY-MUP2401HT8P-E1	MMY-MUP2401HT8P-E1	
			MMY-MUP2401HT8P-E1	MMY-MUP2401HT8P-E1	MMY-MUP2401HT8P-E1	
			MMY-MUP2401HT8P-E1	MMY-MUP2001HT8P-E	MMY-MUP2201HT8P-E	
			MMY-MUP1401HT8P-E	MMY-MUP2001HT8P-E	MMY-MUP2001HT8P-E	
Outdoor unit type			Inverter unit	Inverter unit	Inverter unit	
Cooling capacity (*1)		kW	241.0	246.0	251.5	
Heating capacity (Rated. *1)		kW	224.5	235.0	240.5	
Heating capacity (Max. *1)		kW	255.0	266.0	272.0	
Capacity range		HP	86	88	90	
Power supply			3N~ 50Hz 400V(380-415V)	3N~ 50Hz 400V(380-415V)	3N~ 50Hz 400V(380-415V)	
Voltage range (*2)		Minimum	V	342	342	
		Maximum	V	456	456	
Electrical characteristic (*1)	Cooling	Running current	A	133.9	129.6	
		Power input	kW	87.12	84.40	
		EER	kW/kW	2.77	2.91	
	Heating (Rated.)	Running current	A	102.8	104.0	
		Power input	kW	66.94	67.82	
		COP	kW/kW	3.35	3.47	
	Heating (Max.)	Running current	A	114.5	118.2	
		Power input	kW	74.44	76.94	
		COP	kW/kW	3.43	3.46	
	SEER				6.91	7.21
	SCOP				4.25	4.30
	Starting current		A	Soft Start		
Weight	Heat pump	kg	356 + 356 + 356 + 228	356 + 356 + 334 + 334	356 + 356 + 356 + 334	
Colour			Silky shade (Munsell 1Y8.5/0.5)			
Compressor	Type	Hermetic rotary compressor				
	Motor output	kW	11.4x2 + 11.4x2 + 11.4x2 + 14.0	11.4x2 + 11.4x2 + 16.9 + 16.9	11.4x2 + 11.4x2 + 9.61x2 + 16.9	
Fan unit	Fan	Propeller fan				
	Motor output	kW	2.0 + 2.0 + 2.0 + 1.0	2.0 + 2.0 + 2.0 + 2.0	2.0 + 2.0 + 2.0 + 2.0	
	Air volume	m3/h	16500 + 16500 + 16500 + 11880	16500 + 16500 + 15900 + 15900	16500 + 16500 + 16500 + 15900	
Max. external static pressure		Pa	80			
Heat exchanger			Finned tube			
Refrigerant	Name	R410A				
	Charge	Heat pump	kg	9.0 + 9.0 + 9.0 + 6.0	9.0 + 9.0 + 9.0 + 9.0	
High-pressure switch		Pa	OFF:3.2 ON:4.15			
Protective devices			(*3)			
Power supply wiring		MCA (*4)	A	60 + 60 + 60 + 31	60 + 60 + 40 + 40	
		MOCP (*5)	A	80 + 80 + 80 + 40	80 + 80 + 50 + 50	
Piping connections	Gas	Type	Brazing			
		Diameter	mm	54.0	54.0	
	Liquid	Type	Brazing			
		Diameter	mm	22.2	22.2	
Max. number of connected indoor units			96	98	100	
Sound pressure level		Cooling	dB(A)	68.5	69.5	
		Heating	dB(A)	72.5	73.5	
Sound power level		Cooling	dB(A)	91.5	92.5	
		Heating	dB(A)	95.0	96.5	
Operation temperature range		Cooling	CDB	-5.0 to 52.0	-5.0 to 52.0	
		Heating(*6)	CWB	-25.0 to 15.5	-25.0 to 15.5	

Note

- (*1) Rated conditions Cooling : Indoor 27 degC Dry Bulb /19 degC Wet Bulb , Outdoor 35 degC Dry Bulb.
 Heating : Indoor 20 degC Dry Bulb, Outdoor 7 degC Dry Bulb / 6 degC WetBulb.
 Based on equivalent piping length of 7.5m and piping height difference of 0m.
 System combination : SMMS-u outdoor unit + MMU-UP***HP-E indoor units.
- (*2) Voltage range : Units are suitable for use on electrical systems where voltage supplied to unit terminal is not below or above listed range limits.
- (*3) Discharge temp. sensor / Suction temp. sensor / High-pressure sensor / Low-pressure sensor / Compressor case thermostat / PC board fuse
- (*4) Select wire size base on the larger value of MCA.
 MCA : Minimum Circuit Amps
- (*5) MOCP : Maximum Overcurrent Protection(Amps)
- (*6) Low ambient heating (-20degC or less) for extended periods of time is not allowed
- (*7) Low ambient cooling (-5 deg C or less) is limited to application.

Model	Name		MMY-UP9211HT8P-E	MMY-UP9411HT8P-E	MMY-UP9611HT8P-E	
	Combination		MMY-MUP2401HT8P-E1	MMY-MUP2401HT8P-E1	MMY-MUP2401HT8P-E1	
Outdoor unit type			Inverter unit	Inverter unit	Inverter unit	
Cooling capacity (*1)		kW	257.0	262.5	268.0	
Heating capacity (Rated. *1)		kW	240.5	246.0	246.0	
Heating capacity (Max. *1)		kW	273.0	279.0	280.0	
Capacity range		HP	92	94	96	
Power supply			3N~ 50Hz 400V(380-415V)	3N~ 50Hz 400V(380-415V)	3N~ 50Hz 400V(380-415V)	
Voltage range (*2)	Minimum	V	342	342	342	
	Maximum	V	456	456	456	
Electrical characteristic (*1)	Cooling	Running current	A	139.0	142.7	148.4
		Power input	kW	90.58	93.00	96.76
		EER	kW/kW	2.84	2.82	2.77
		Heating (Rated.)	Running current	A	110.2	112.1
	Power input		kW	71.87	73.12	75.92
	COP		kW/kW	3.35	3.36	3.24
	Heating (Max.)	Running current	A	122.9	124.9	127.6
		Power input	kW	80.01	81.32	83.08
		COP	kW/kW	3.41	3.43	3.37
	SEER			7.03	6.95	6.87
	SCOP			4.24	4.24	4.17
	Starting current	A	Soft Start			Soft Start
Weight	Heat pump	kg	356 + 356 + 356 + 334	356 + 356 + 356 + 356	356 + 356 + 356 + 356	
Colour			Silky shade (Munsell 1Y8.5/0.5)	Silky shade (Munsell 1Y8.5/0.5)	Silky shade (Munsell 1Y8.5/0.5)	
Compressor	Type	Hermetic rotary compressor			Hermetic rotary compressor	
	Motor output	kW	11.4x2 + 11.4x2 + 11.4x2 + 16.9	11.4x2 + 11.4x2 + 11.4x2 + 9.61x2	11.4x2 + 11.4x2 + 11.4x2 + 11.4x2	
Fan unit	Fan	Propeller fan			Propeller fan	
	Motor output	kW	2.0 + 2.0 + 2.0 + 2.0	2.0 + 2.0 + 2.0 + 2.0	2.0 + 2.0 + 2.0 + 2.0	
	Air volume	m3/h	16500 + 16500 + 16500 + 15900	16500 + 16500 + 16500 + 16500	16500 + 16500 + 16500 + 16500	
Max. external static pressure		Pa	80	80	80	
Heat exchanger			Finned tube	Finned tube	Finned tube	
Refrigerant	Name	R410A			R410A	
	Charge	Heat pump	kg	9.0 + 9.0 + 9.0 + 9.0	9.0 + 9.0 + 9.0 + 9.0	
High-pressure switch		Pa	OFF:3.2 ON:4.15	OFF:3.2 ON:4.15	OFF:3.2 ON:4.15	
Protective devices			(*3)	(*3)	(*3)	
Power supply wiring	MCA (*4)	A	60 + 60 + 60 + 40	60 + 60 + 60 + 57	60 + 60 + 60 + 60	
	MOCP (*5)	A	80 + 80 + 80 + 50	80 + 80 + 80 + 63	80 + 80 + 80 + 80	
Piping connections	Gas	Type	Brazing			
		Diameter	mm	54.0	54.0	54.0
	Liquid	Type	Brazing			
		Diameter	mm	22.2	22.2	22.2
Max. number of connected indoor units			102	104	106	
Sound pressure level	Cooling	dB(A)	69.5	69.5	69.5	
	Heating	dB(A)	73.5	73.5	73.5	
Sound power level	Cooling	dB(A)	92.5	92.5	92.5	
	Heating	dB(A)	96.5	96.5	96.5	
Operation temperature range	Cooling	CDB	-5.0 to 52.0	-5.0 to 52.0	-5.0 to 52.0	
	Heating(*6)	CWB	-25.0 to 15.5	-25.0 to 15.5	-25.0 to 15.5	

Note

- (*1) Rated conditions Cooling : Indoor 27 degC Dry Bulb /19 degC Wet Bulb , Outdoor 35 degC Dry Bulb.
Heating : Indoor 20 degC Dry Bulb, Outdoor 7 degC Dry Bulb / 6 degC WetBulb.
Based on equivalent piping length of 7.5m and piping height difference of 0m.
System combination : SMMS-u outdoor unit + MMU-UP***HP-E indoor units.
- (*2) Voltage range : Units are suitable for use on electrical systems where voltage supplied to unit terminal is not below or above listed range limits.
- (*3) Discharge temp. sensor / Suction temp. sensor / High-pressure sensor / Low-pressure sensor / Compressor case thermostat / PC board fuse
- (*4) Select wire size base on the larger value of MCA.
MCA : Minimum Circuit Amps
- (*5) MOCP : Maximum Overcurrent Protection(Amps)
- (*6) Low ambient heating (-20degC or less) for extended periods of time is not allowed
- (*7) Low ambient cooling (-5 deg C or less) is limited to application.

Model	Name		MMY-UP9811HT8P-E	MMY-UP10011HT8P-E	MMY-UP10211HT8P-E	
	Combination		MMY-MUP2401HT8P-E1	MMY-MUP2401HT8P-E1	MMY-MUP2401HT8P-E1	
			MMY-MUP2401HT8P-E1	MMY-MUP2401HT8P-E1	MMY-MUP2401HT8P-E1	
			MMY-MUP2401HT8P-E1	MMY-MUP2401HT8P-E1	MMY-MUP2001HT8P-E	
			MMY-MUP1401HT8P-E	MMY-MUP1401HT8P-E	MMY-MUP2001HT8P-E	
Outdoor unit type			Inverter unit	Inverter unit	Inverter unit	
Cooling capacity (*1)		kW	274.5	281.0	286.0	
Heating capacity (Rated. *1)		kW	258.0	264.5	275.0	
Heating capacity (Max. *1)		kW	292.5	300.0	311.0	
Capacity range		HP	98	100	102	
Power supply			3N~ 50Hz 400V(380-415V)	3N~ 50Hz 400V(380-415V)	3N~ 50Hz 400V(380-415V)	
Voltage range (*2)		Minimum	V	342	342	
		Maximum	V	456	456	
Electrical characteristic (*1)	Cooling	Running current	A	149.9	156.5	152.2
		Power input	kW	97.46	101.67	98.95
		EER	kW/kW	2.82	2.76	2.89
		Running current	A	114.9	118.3	119.5
	Heating (Rated.)	Power input	kW	74.71	76.94	77.82
		COP	kW/kW	3.45	3.44	3.53
		Running current	A	128.3	133.3	137.0
	Heating (Max.)	Power input	kW	83.31	86.57	89.07
		COP	kW/kW	3.51	3.47	3.49
		SEER		6.95	6.94	7.20
	SCOP			4.31	4.30	4.34
	Starting current		A	Soft Start	Soft Start	Soft Start
Weight	Heat pump	kg	356 + 356 + 356 + 228 + 228	356 + 356 + 356 + 228 + 228	356 + 356 + 334 + 334 + 228	
Colour			Silky shade (Munsell 1Y8.5/0.5)	Silky shade (Munsell 1Y8.5/0.5)	Silky shade (Munsell 1Y8.5/0.5)	
Compressor	Type		Hermetic rotary compressor	Hermetic rotary compressor	Hermetic rotary compressor	
	Motor output	kW	11.4x2 + 11.4x2 + 11.4x2 + 14.0 + 9.75	11.4x2 + 11.4x2 + 11.4x2 + 14.0 + 14.0	11.4x2 + 11.4x2 + 16.9 + 16.9 + 14.0	
Fan unit	Fan		Propeller fan	Propeller fan	Propeller fan	
	Motor output	kW	2.0 + 2.0 + 2.0 + 1.0 + 1.0	2.0 + 2.0 + 2.0 + 1.0 + 1.0	2.0 + 2.0 + 2.0 + 2.0 + 1.0	
	Air volume	m3/h	16500 + 16500 + 16500 + 11880 + 11700	16500 + 16500 + 16500 + 11880 + 11880	16500 + 16500 + 15900 + 15900 + 11880	
Max. external static pressure		Pa	80	80	80	
Heat exchanger			Finned tube	Finned tube	Finned tube	
Refrigerant	Name		R410A	R410A	R410A	
	Charge	kg	9.0 + 9.0 + 9.0 + 6.0 + 6.0	9.0 + 9.0 + 9.0 + 6.0 + 6.0	9.0 + 9.0 + 9.0 + 9.0 + 6.0	
High-pressure switch		Pa	OFF:3.2 ON:4.15	OFF:3.2 ON:4.15	OFF:3.2 ON:4.15	
Protective devices			(*3)	(*3)	(*3)	
Power supply wiring		MCA (*4)	A	60 + 60 + 60 + 31 + 27	60 + 60 + 60 + 31 + 31	60 + 60 + 40 + 40 + 31
		MOCP (*5)	A	80 + 80 + 80 + 40 + 32	80 + 80 + 80 + 40 + 40	80 + 80 + 50 + 50 + 40
Piping connections	Gas	Type		Brazing	Brazing	
		Diameter	mm	54.0	54.0	54.0
	Liquid	Type		Brazing	Brazing	Brazing
		Diameter	mm	22.2	22.2	22.2
Max. number of connected indoor units			108	110	112	
Sound pressure level	Cooling	dB(A)	69.0	69.0	69.5	
	Heating	dB(A)	73.0	73.0	73.5	
Sound power level	Cooling	dB(A)	91.5	91.5	92.5	
	Heating	dB(A)	95.5	95.5	96.5	
Operation temperature range	Cooling	CDB	-5.0 to 52.0	-5.0 to 52.0	-5.0 to 52.0	
	Heating(*6)	CWB	-25.0 to 15.5	-25.0 to 15.5	-25.0 to 15.5	

Note

(*1) Rated conditions Cooling : Indoor 27 degC Dry Bulb /19 degC Wet Bulb , Outdoor 35 degC Dry Bulb.
 Heating : Indoor 20 degC Dry Bulb, Outdoor 7 degC Dry Bulb / 6 degC WetBulb.
 Based on equivalent piping length of 7.5m and piping height difference of 0m.
 System combination : SMMS-u outdoor unit + MMU-UP***HP-E indoor units.

(*2) Voltage range : Units are suitable for use on electrical systems where voltage supplied to unit terminal is not below or above listed range limits.

(*3) Discharge temp. sensor / Suction temp. sensor / High-pressure sensor / Low-pressure sensor / Compressor case thermostat / PC board fuse

(*4) Select wire size base on the larger value of MCA.

MCA : Minimum Circuit Amps

(*5) MOCP : Maximum Overcurrent Protection(Amps)

(*6) Low ambient heating (-20degC or less) for extended periods of time is not allowed

(*7) Low ambient cooling (-5 deg C or less) is limited to application.

Model	Name		MMY-UP10411HT8P-E	MMY-UP10611HT8P-E	MMY-UP10811HT8P-E	
	Combination		MMY-MUP2401HT8P-E1	MMY-MUP2401HT8P-E1	MMY-MUP2401HT8P-E1	
			MMY-MUP2401HT8P-E1	MMY-MUP2401HT8P-E1	MMY-MUP2401HT8P-E1	
			MMY-MUP2401HT8P-E1	MMY-MUP2401HT8P-E1	MMY-MUP2401HT8P-E1	
			MMY-MUP2001HT8P-E	MMY-MUP2001HT8P-E	MMY-MUP2401HT8P-E1	
Outdoor unit type			Inverter unit	Inverter unit	Inverter unit	
Cooling capacity (*1)		kW	290.5	297.0	301.5	
Heating capacity (Rated. *1)		kW	274.0	280.5	279.5	
Heating capacity (Max. *1)		kW	310.5	318.0	317.5	
Capacity range		HP	104	106	108	
Power supply			3N~ 50Hz 400V(380-415V)	3N~ 50Hz 400V(380-415V)	3N~ 50Hz 400V(380-415V)	
Voltage range (*2)		Minimum	V	342	342	
		Maximum	V	456	456	
Electrical characteristic (*1)	Cooling	Running current	A	155.0	161.6	164.4
		Power input	kW	100.92	105.13	107.10
		EER	kW/kW	2.88	2.83	2.82
		Running current	A	122.3	125.7	128.5
	Heating (Rated.)	Power input	kW	79.64	81.87	83.69
		COP	kW/kW	3.44	3.43	3.34
		Running current	A	136.7	141.7	141.4
	Heating (Max.)	Power input	kW	88.88	92.14	91.95
		COP	kW/kW	3.49	3.45	3.45
		SEER		7.08	7.04	6.93
	SCOP			4.30	4.29	4.24
	Starting current		A	Soft Start	Soft Start	Soft Start
Weight	Heat pump	kg	356 + 356 + 356 + 334 + 228	356 + 356 + 356 + 334 + 228	356 + 356 + 356 + 356 + 228	
Colour			Silky shade (Munsell 1Y8.5/0.5)	Silky shade (Munsell 1Y8.5/0.5)	Silky shade (Munsell 1Y8.5/0.5)	
Compressor	Type		Hermetic rotary compressor	Hermetic rotary compressor	Hermetic rotary compressor	
	Motor output	kW	11.4x2 + 11.4x2 + 11.4x2 + 16.9 + 9.75	11.4x2 + 11.4x2 + 11.4x2 + 16.9 + 14.0	11.4x2 + 11.4x2 + 11.4x2 + 11.4x2 + 9.75	
Fan unit	Fan		Propeller fan	Propeller fan	Propeller fan	
	Motor output	kW	2.0 + 2.0 + 2.0 + 2.0 + 1.0	2.0 + 2.0 + 2.0 + 2.0 + 1.0	2.0 + 2.0 + 2.0 + 2.0 + 1.0	
	Air volume	m3/h	16500 + 16500 + 16500 + 15900 + 11700	16500 + 16500 + 16500 + 15900 + 11880	16500 + 16500 + 16500 + 16500 + 11700	
Max. external static pressure		Pa	80	80	80	
Heat exchanger			Finned tube	Finned tube	Finned tube	
Refrigerant	Name		R410A	R410A	R410A	
	Charge	kg	9.0 + 9.0 + 9.0 + 9.0 + 6.0	9.0 + 9.0 + 9.0 + 9.0 + 6.0	9.0 + 9.0 + 9.0 + 9.0 + 6.0	
High-pressure switch		Pa	OFF:3.2 ON:4.15	OFF:3.2 ON:4.15	OFF:3.2 ON:4.15	
Protective devices			(*3)	(*3)	(*3)	
Power supply wiring		MCA (*4)	A	60 + 60 + 60 + 40 + 27	60 + 60 + 60 + 40 + 27	
		MOCP (*5)	A	80 + 80 + 80 + 50 + 32	80 + 80 + 80 + 50 + 40	80 + 80 + 80 + 80 + 32
Piping connections	Gas	Type		Brazing	Brazing	
		Diameter	mm	54.0	54.0	54.0
	Liquid	Type		Brazing	Brazing	Brazing
		Diameter	mm	22.2	22.2	22.2
Max. number of connected indoor units			114	116	118	
Sound pressure level	Cooling	dB(A)	69.5	69.5	69.5	
	Heating	dB(A)	73.5	73.5	73.5	
Sound power level	Cooling	dB(A)	92.5	92.5	92.5	
	Heating	dB(A)	96.5	96.5	96.5	
Operation temperature range		Cooling	CDB	-5.0 to 52.0	-5.0 to 52.0	
		Heating(*6)	CWB	-25.0 to 15.5	-25.0 to 15.5	-25.0 to 15.5

Note

(*1) Rated conditions Cooling : Indoor 27 degC Dry Bulb /19 degC Wet Bulb , Outdoor 35 degC Dry Bulb.
 Heating : Indoor 20 degC Dry Bulb, Outdoor 7 degC Dry Bulb / 6 degC WetBulb.
 Based on equivalent piping length of 7.5m and piping height difference of 0m.
 System combination : SMMS-u outdoor unit + MMU-UP***HP-E indoor units.

(*2) Voltage range : Units are suitable for use on electrical systems where voltage supplied to unit terminal is not below or above listed range limits.

(*3) Discharge temp. sensor / Suction temp. sensor / High-pressure sensor / Low-pressure sensor / Compressor case thermostat / PC board fuse

(*4) Select wire size base on the larger value of MCA.

MCA : Minimum Circuit Amps

(*5) MOCP : Maximum Overcurrent Protection(Amps)

(*6) Low ambient heating (-20degC or less) for extended periods of time is not allowed

(*7) Low ambient cooling (-5 deg C or less) is limited to application.

Model	Name		MMY-UP11011HT8P-E	MMY-UP11211HT8P-E	MMY-UP11411HT8P-E	
	Combination		MMY-MUP2401HT8P-E1	MMY-MUP2401HT8P-E1	MMY-MUP2401HT8P-E1	
			MMY-MUP2401HT8P-E1	MMY-MUP2401HT8P-E1	MMY-MUP2401HT8P-E1	
			MMY-MUP2401HT8P-E1	MMY-MUP2401HT8P-E1	MMY-MUP2401HT8P-E1	
			MMY-MUP2401HT8P-E1	MMY-MUP2001HT8P-E	MMY-MUP2001HT8P-E	
Outdoor unit type			Inverter unit	Inverter unit	Inverter unit	
Cooling capacity (*1)		kW	308.0	313.0	318.5	
Heating capacity (Rated. *1)		kW	286.0	296.5	302.0	
Heating capacity (Max. *1)		kW	325.0	336.0	342.0	
Capacity range		HP	110	112	114	
Power supply			3N~ 50Hz 400V(380-415V)	3N~ 50Hz 400V(380-415V)	3N~ 50Hz 400V(380-415V)	
Voltage range (*2)		Minimum	V	342	342	
		Maximum	V	456	456	
Electrical characteristic (*1)	Cooling	Running current	A	171.0	166.7	170.4
		Power input	kW	111.31	108.59	111.01
		EER	kW/kW	2.77	2.88	2.87
	Heating (Rated.)	Running current	A	131.9	133.1	135.0
		Power input	kW	85.92	86.80	88.05
		COP	kW/kW	3.33	3.42	3.43
	Heating (Max.)	Running current	A	146.4	150.1	152.1
		Power input	kW	95.21	97.71	99.02
		COP	kW/kW	3.41	3.44	3.45
	SEER			6.90	7.13	7.07
	SCOP			4.23	4.28	4.28
	Starting current		A	Soft Start	Soft Start	Soft Start
Weight	Heat pump	kg	356 + 356 + 356 + 356 + 228	356 + 356 + 356 + 334 + 334	356 + 356 + 356 + 356 + 334	
Colour			Silky shade (Munsell 1Y8.5/0.5)	Silky shade (Munsell 1Y8.5/0.5)	Silky shade (Munsell 1Y8.5/0.5)	
Compressor	Type		Hermetic rotary compressor	Hermetic rotary compressor	Hermetic rotary compressor	
	Motor output	kW	11.4x2 + 11.4x2 + 11.4x2 + 11.4x2 + 14.0	11.4x2 + 11.4x2 + 11.4x2 + 16.9 + 16.9	11.4x2 + 11.4x2 + 11.4x2 + 9.61x2 + 16.9	
Fan unit	Fan		Propeller fan	Propeller fan	Propeller fan	
	Motor output	kW	2.0 + 2.0 + 2.0 + 2.0 + 1.0	2.0 + 2.0 + 2.0 + 2.0 + 2.0	2.0 + 2.0 + 2.0 + 2.0 + 2.0	
	Air volume	m ³ /h	16500 + 16500 + 16500 + 16500 + 11880	16500 + 16500 + 16500 + 15900 + 15900	16500 + 16500 + 16500 + 16500 + 15900	
Max. external static pressure		Pa	80	80	80	
Heat exchanger			Finned tube	Finned tube	Finned tube	
Refrigerant	Name		R410A	R410A	R410A	
	Charge	kg	9.0 + 9.0 + 9.0 + 9.0 + 6.0	9.0 + 9.0 + 9.0 + 9.0 + 9.0	9.0 + 9.0 + 9.0 + 9.0 + 9.0	
High-pressure switch		Pa	OFF:3.2 ON:4.15	OFF:3.2 ON:4.15	OFF:3.2 ON:4.15	
Protective devices			(*3)	(*3)	(*3)	
Power supply wiring		MCA (*4)	A	60 + 60 + 60 + 60 + 31	60 + 60 + 60 + 40 + 40	60 + 60 + 60 + 57 + 40
		MOCP (*5)	A	80 + 80 + 80 + 80 + 40	80 + 80 + 80 + 50 + 50	80 + 80 + 80 + 63 + 50
Piping connections	Gas	Type	Brazing	Brazing	Brazing	
		Diameter	mm	54.0	54.0	54.0
	Liquid	Type	Brazing	Brazing	Brazing	
		Diameter	mm	22.2	22.2	22.2
Max. number of connected indoor units			120	122	124	
Sound pressure level		Cooling	dB(A)	69.5	70.0	70.0
		Heating	dB(A)	73.5	74.0	74.0
Sound power level		Cooling	dB(A)	92.5	93.0	93.0
		Heating	dB(A)	96.5	97.0	97.0
Operation temperature range		Cooling	CDB	-5.0 to 52.0	-5.0 to 52.0	-5.0 to 52.0
		Heating(*6)	CWB	-25.0 to 15.5	-25.0 to 15.5	-25.0 to 15.5

Note

(*1) Rated conditions Cooling : Indoor 27 degC Dry Bulb / 19 degC Wet Bulb , Outdoor 35 degC Dry Bulb.
 Heating : Indoor 20 degC Dry Bulb, Outdoor 7 degC Dry Bulb / 6 degC WetBulb.
 Based on equivalent piping length of 7.5m and piping height difference of 0m.
 System combination : SMMS-u outdoor unit + MMU-UP***HP-E indoor units.

(*2) Voltage range : Units are suitable for use on electrical systems where voltage supplied to unit terminal is not below or above listed range limits.

(*3) Discharge temp. sensor / Suction temp. sensor / High-pressure sensor / Low-pressure sensor / Compressor case thermostat / PC board fuse

(*4) Select wire size base on the larger value of MCA.

MCA : Minimum Circuit Amps

(*5) MOCP : Maximum Overcurrent Protection(Amps)

(*6) Low ambient heating (-20degC or less) for extended periods of time is not allowed

(*7) Low ambient cooling (-5 deg C or less) is limited to application.

Model	Name		MMY-UP11611HT8P-E	MMY-UP11811HT8P-E	MMY-UP12011HT8P-E	
	Combination		MMY-MUP2401HT8P-E1	MMY-MUP2401HT8P-E1	MMY-MUP2401HT8P-E1	
			MMY-MUP2401HT8P-E1	MMY-MUP2401HT8P-E1	MMY-MUP2401HT8P-E1	
			MMY-MUP2401HT8P-E1	MMY-MUP2401HT8P-E1	MMY-MUP2401HT8P-E1	
			MMY-MUP2401HT8P-E1	MMY-MUP2401HT8P-E1	MMY-MUP2401HT8P-E1	
Outdoor unit type			Inverter unit	Inverter unit	Inverter unit	
Cooling capacity (*1)		kW	324.0	329.5	335.0	
Heating capacity (Rated. *1)		kW	302.0	307.5	307.5	
Heating capacity (Max. *1)		kW	343.0	349.0	350.0	
Capacity range		HP	116	118	120	
Power supply			3N~ 50Hz 400V(380-415V)	3N~ 50Hz 400V(380-415V)	3N~ 50Hz 400V(380-415V)	
Voltage range (*2)		Minimum	V	342	342	
		Maximum	V	456	456	
Electrical characteristic (*1)	Cooling	Running current	A	176.1	179.8	185.5
		Power input	kW	114.77	117.19	120.95
		EER	kW/kW	2.82	2.81	2.77
		Running current	A	139.3	141.2	145.5
	Heating (Rated.)	Power input	kW	90.85	92.10	94.90
		COP	kW/kW	3.32	3.34	3.24
		Running current	A	154.8	156.8	159.5
	Heating (Max.)	Power input	kW	100.78	102.09	103.85
		COP	kW/kW	3.40	3.42	3.37
	SEER			7.00	6.93	6.87
	SCOP			4.22	4.23	4.17
	Starting current		A	Soft Start	Soft Start	Soft Start
Weight	Heat pump	kg	356 + 356 + 356 + 356 + 334	356 + 356 + 356 + 356 + 356	356 + 356 + 356 + 356 + 356	
Colour			Silky shade (Munsell 1Y8.5/0.5)	Silky shade (Munsell 1Y8.5/0.5)	Silky shade (Munsell 1Y8.5/0.5)	
Compressor	Type		Hermetic rotary compressor	Hermetic rotary compressor	Hermetic rotary compressor	
	Motor output	kW	11.4x2 + 11.4x2 + 11.4x2 + 11.4x2 + 16.9	11.4x2 + 11.4x2 + 11.4x2 + 11.4x2 + 9.61x2	11.4x2 + 11.4x2 + 11.4x2 + 11.4x2 + 11.4x2	
Fan unit	Fan		Propeller fan	Propeller fan	Propeller fan	
	Motor output	kW	2.0 + 2.0 + 2.0 + 2.0 + 2.0	2.0 + 2.0 + 2.0 + 2.0 + 2.0	2.0 + 2.0 + 2.0 + 2.0 + 2.0	
	Air volume	m3/h	16500 + 16500 + 16500 + 16500 + 15900	16500 + 16500 + 16500 + 16500 + 16500	16500 + 16500 + 16500 + 16500 + 16500	
Max. external static pressure		Pa	80	80	80	
Heat exchanger			Finned tube	Finned tube	Finned tube	
Refrigerant	Name		R410A	R410A	R410A	
	Charge	Heat pump	kg	9.0 + 9.0 + 9.0 + 9.0 + 9.0	9.0 + 9.0 + 9.0 + 9.0 + 9.0	
High-pressure switch		Pa	OFF:3.2 ON:4.15	OFF:3.2 ON:4.15	OFF:3.2 ON:4.15	
Protective devices			(*3)	(*3)	(*3)	
Power supply wiring		MCA (*4)	A	60 + 60 + 60 + 60 + 40	60 + 60 + 60 + 60 + 57	
		MOCP (*5)	A	80 + 80 + 80 + 80 + 50	80 + 80 + 80 + 80 + 63	
Piping connections	Gas	Type		Brazing	Brazing	
		Diameter	mm	54.0	54.0	
	Liquid	Type		Brazing	Brazing	
		Diameter	mm	22.2	22.2	
Max. number of connected indoor units			126	128	128	
Sound pressure level	Cooling	dB(A)	70.0	70.0	70.0	
	Heating	dB(A)	74.0	74.0	74.0	
Sound power level	Cooling	dB(A)	93.0	93.0	93.0	
	Heating	dB(A)	97.0	97.0	97.0	
Operation temperature range		Cooling	CDB	-5.0 to 52.0	-5.0 to 52.0	
		Heating(*6)	CWB	-25.0 to 15.5	-25.0 to 15.5	

Note

(*1) Rated conditions Cooling : Indoor 27 degC Dry Bulb /19 degC Wet Bulb , Outdoor 35 degC Dry Bulb.
 Heating : Indoor 20 degC Dry Bulb, Outdoor 7 degC Dry Bulb / 6 degC WetBulb.
 Based on equivalent piping length of 7.5m and piping height difference of 0m.
 System combination : SMMS-u outdoor unit + MMU-UP***HP-E indoor units.

(*2) Voltage range : Units are suitable for use on electrical systems where voltage supplied to unit terminal is not below or above listed range limits.

(*3) Discharge temp. sensor / Suction temp. sensor / High-pressure sensor / Low-pressure sensor / Compressor case thermostat / PC board fuse

(*4) Select wire size base on the larger value of MCA.

MCA : Minimum Circuit Amps

(*5) MOCP : Maximum Overcurrent Protection(Amps)

(*6) Low ambient heating (-20degC or less) for extended periods of time is not allowed

(*7) Low ambient cooling (-5 deg C or less) is limited to application.

5-2. Dimensional drawing

Single unit

Model : MMY-MUP0801HT8P-E, MMY-MUP1001HT8P-E
 MMY-MUP1201HT8P-E, MMY-MUP1401HT8P-E

(Note)

1. If there is an obstacle at the upper side of the outdoor unit, set the top end of the outdoor unit 2000mm apart from the obstacle.
2. Draw out the pipe procured locally to the front of the outdoor unit horizontally, and keep 500mm or more between the outdoor unit and traversing pipe if placing pipe transversely.

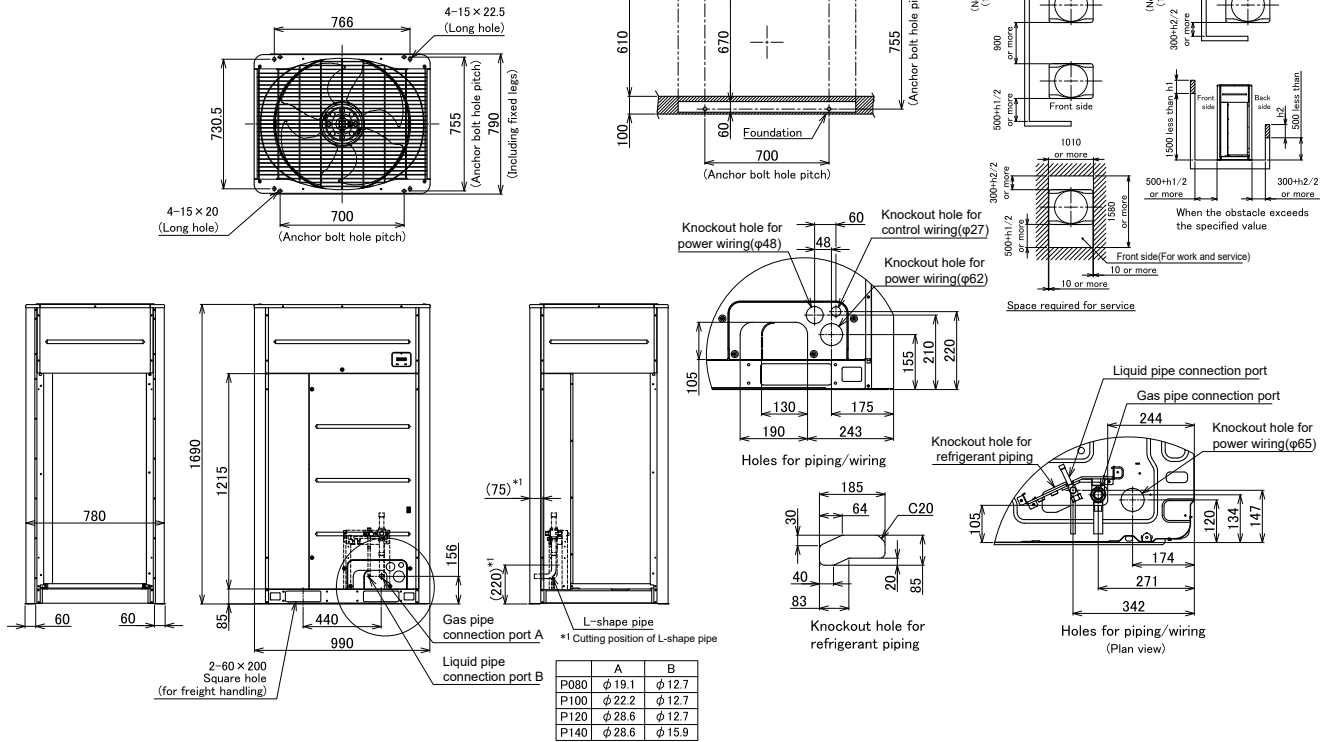

(Unit : mm)

**Model : MMY-MUP1601HT8P-E, MMY-MUP1801HT8P-E
 MMY-MUP2001HT8P-E, MMY-MUP2201HT8P-E,
 MMY-MUP2401HT8P-E1**

(Note)

1. If there is an obstacle at the upper side of the outdoor unit, set the top end of the outdoor unit 2000mm apart from the obstacle.
2. Draw out the pipe procured locally to the front of the outdoor unit horizontally, and keep 500mm or more between the outdoor unit and traversing pipe if placing pipe transversely.

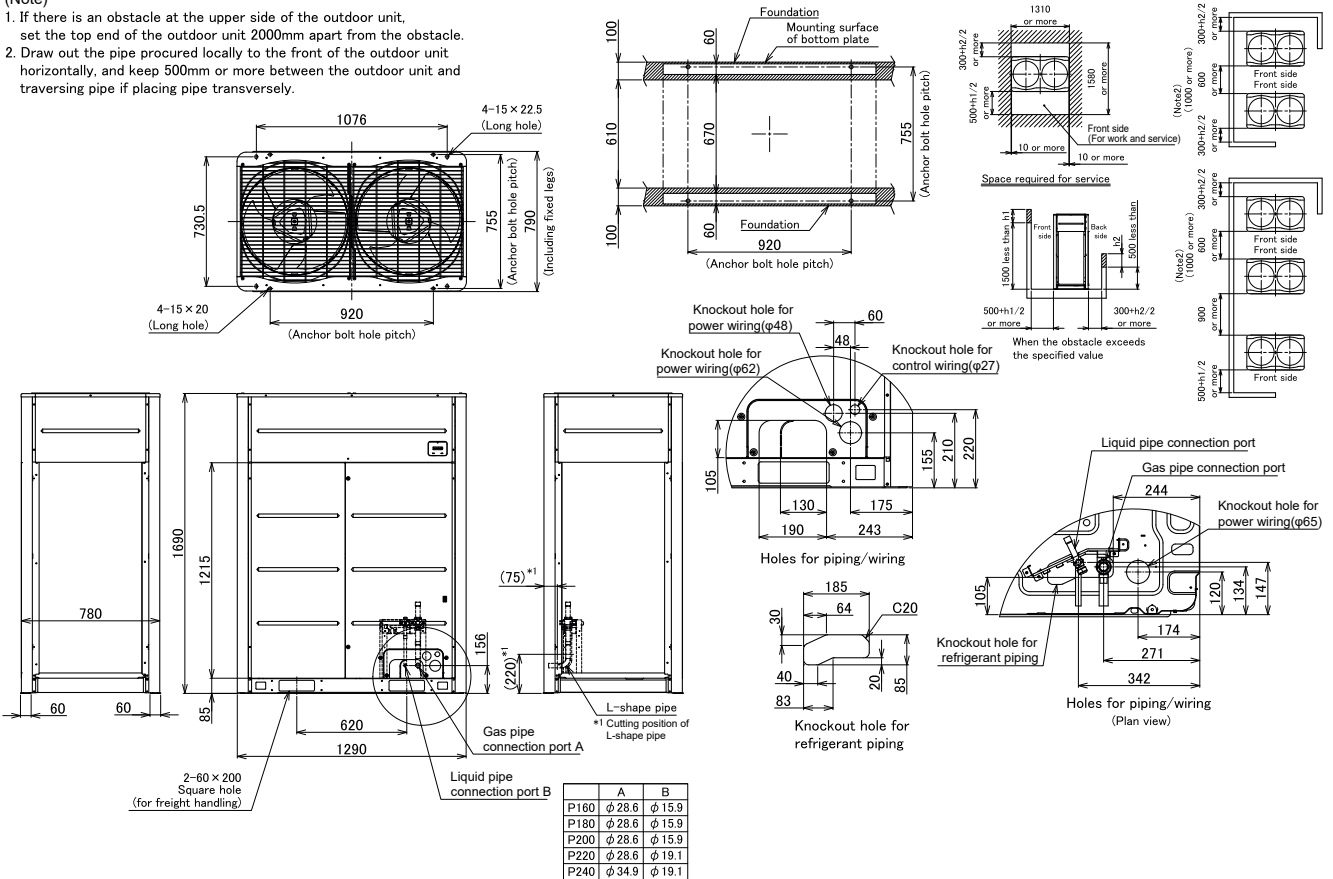

(Unit : mm)

Combination

Model	Outdoor unit	
	(1) Header unit	(2) Follower unit
MMY-UP2611HT8P-E	MMY-MUP1401HT8P-E	MMY-MUP1201HT8P-E
MMY-UP2811HT8P-E	MMY-MUP1401HT8P-E	MMY-MUP1401HT8P-E

Two units connected

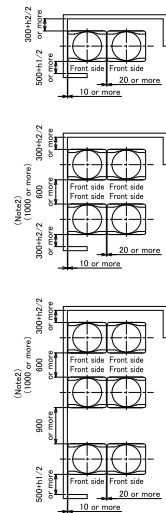
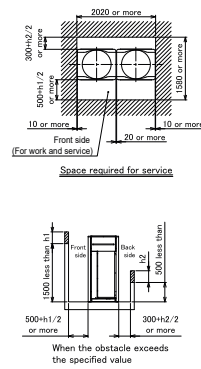
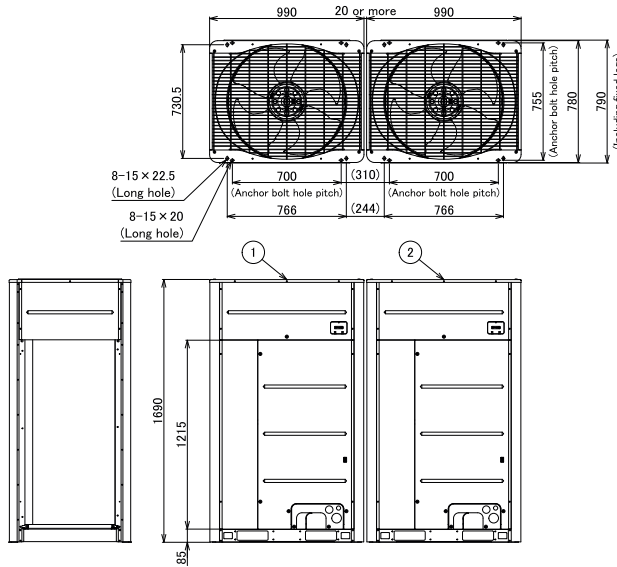

- (Note)
1. If there is an obstacle at the upper side of the outdoor unit, set the top end of the outdoor unit 2000mm apart from the obstacle.
 2. Draw out the pipe procured locally to the front of the outdoor unit horizontally, and keep 500mm or more between the outdoor unit and traversing pipe if placing pipe transversely.
 3. Arrange each outdoor unit in order of its capacity.
(Header unit ① ≥ Follower unit ②)

(Unit:mm)

Model	Outdoor unit	
	(1) Header unit	(2) Follower unit
MMY-UP3011HT8P-E	MMY-MUP1801HT8P-E	MMY-MUP1201HT8P-E
MMY-UP3211HT8P-E	MMY-MUP2001HT8P-E	MMY-MUP1201HT8P-E
MMY-UP3411HT8P-E	MMY-MUP2001HT8P-E	MMY-MUP1401HT8P-E
MMY-UP3611HT8P-E	MMY-MUP2401HT8P-E1	MMY-MUP1201HT8P-E
MMY-UP3811HT8P-E	MMY-MUP2401HT8P-E1	MMY-MUP1401HT8P-E

Two units connected

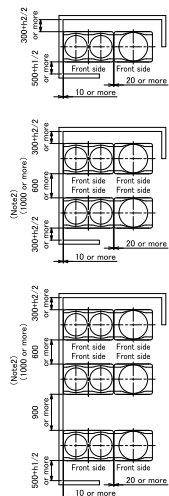
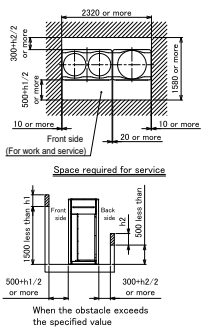
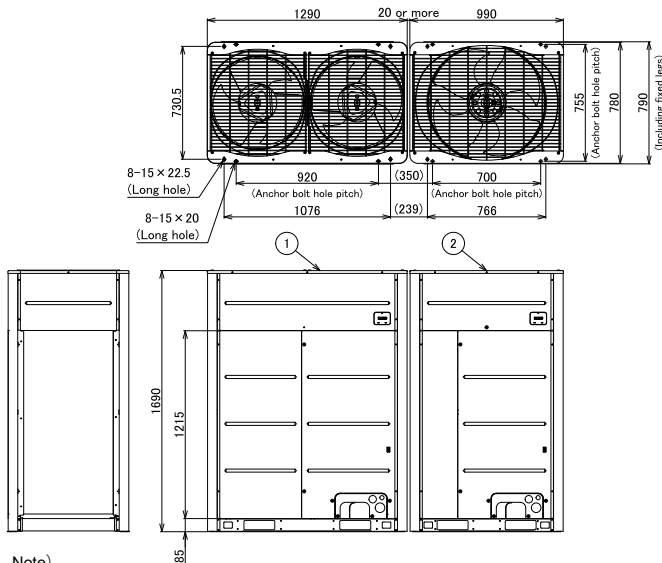

- (Note)
1. If there is an obstacle at the upper side of the outdoor unit, set the top end of the outdoor unit 2000mm apart from the obstacle.
 2. Draw out the pipe procured locally to the front of the outdoor unit horizontally, and keep 500mm or more between the outdoor unit and traversing pipe if placing pipe transversely.
 3. Arrange each outdoor unit in order of its capacity.
(Header unit ① ≥ Follower unit ②)

(Unit:mm)

Combination

Model	Outdoor unit	
	(1) Header unit	(2) Follower unit
MMY-UP4011HT8P-E	MMY-MUP2001HT8P-E	MMY-MUP2001HT8P-E
MMY-UP4211HT8P-E	MMY-MUP2401HT8P-E1	MMY-MUP1801HT8P-E
MMY-UP4411HT8P-E	MMY-MUP2401HT8P-E1	MMY-MUP2001HT8P-E
MMY-UP4611HT8P-E	MMY-MUP2401HT8P-E1	MMY-MUP2201HT8P-E
MMY-UP4811HT8P-E	MMY-MUP2401HT8P-E1	MMY-MUP2401HT8P-E1

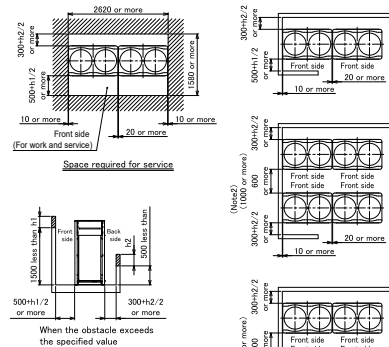
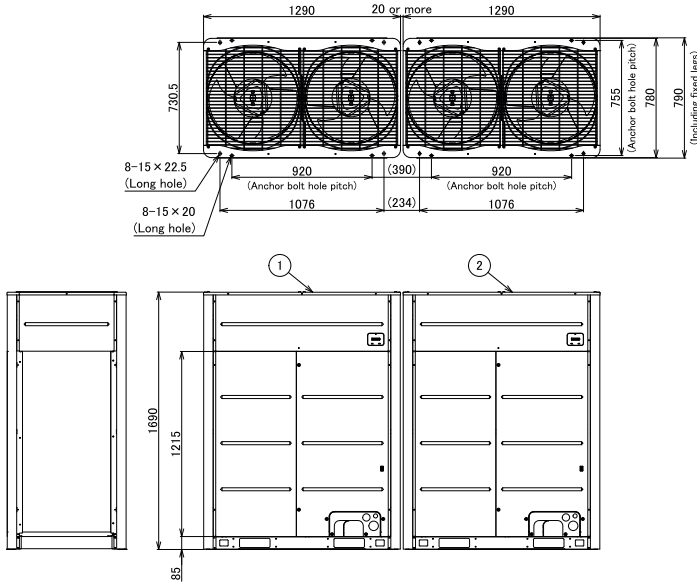

Two units connected

- (Note)
1. If there is an obstacle at the upper side of the outdoor unit, set the top end of the outdoor unit 2000mm apart from the obstacle.
 2. Draw out the pipe procured locally to the front of the outdoor unit horizontally, and keep 500mm or more between the outdoor unit and traversing pipe if placing pipe transversely.
 3. Arrange each outdoor unit in order of its capacity.
(Header unit ① ≥ Follower unit ②)

(Unit:mm)

Model	Outdoor unit		
	(1) Header unit	(2) Follower unit	(3) Follower unit
MMY-UP5011HT8P-E	MMY-MUP2401HT8P-E1	MMY-MUP1401HT8P-E	MMY-MUP1201HT8P-E
MMY-UP5211HT8P-E	MMY-MUP2401HT8P-E1	MMY-MUP1401HT8P-E	MMY-MUP1401HT8P-E

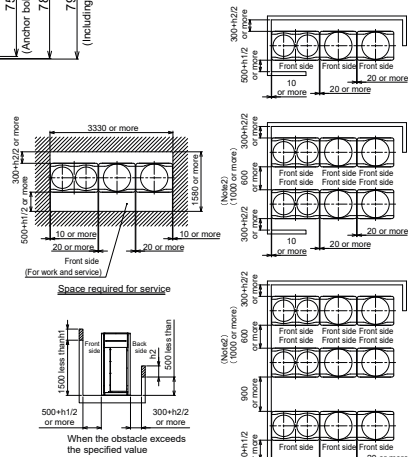
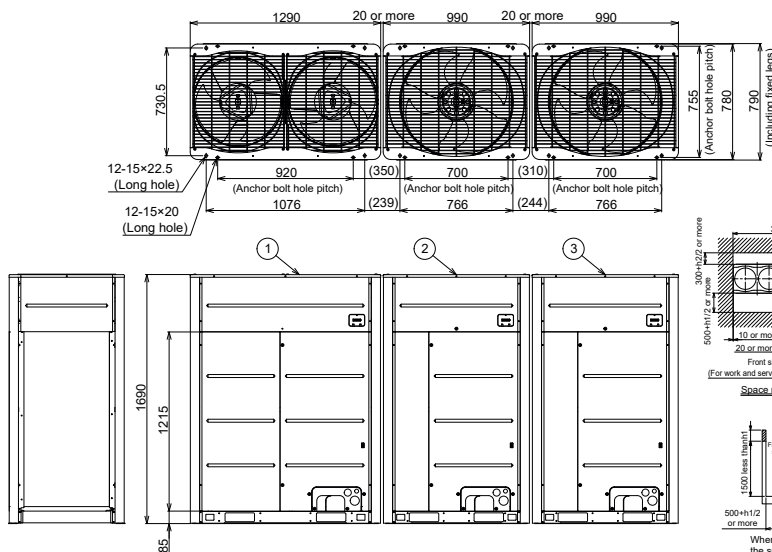

Three units connected

- (Note)
1. If there is an obstacle at the upper side of the outdoor unit, set the top end of the outdoor unit 2000mm apart from the obstacle.
 2. Draw out the pipe procured locally to the front of the outdoor unit horizontally, and keep 500mm or more between the outdoor unit and traversing pipe if placing pipe transversely.
 3. Arrange each outdoor unit in order of its capacity.
(Header unit ① ≥ Follower unit ② ≥ Follower unit ③)

(Unit:mm)

Model	Outdoor unit		
	(1) Header unit	(2) Follower unit	(3) Follower unit
MMY-UP5411HT8P-E	MMY-MUP2001HT8P-E	MMY-MUP2001HT8P-E	MMY-MUP1401HT8P-E
MMY-UP5611HT8P-E	MMY-MUP2401HT8P-E1	MMY-MUP2001HT8P-E	MMY-MUP1201HT8P-E
MMY-UP5811HT8P-E	MMY-MUP2401HT8P-E1	MMY-MUP2401HT8P-E1	MMY-MUP1401HT8P-E
MMY-UP6011HT8P-E	MMY-MUP2401HT8P-E1	MMY-MUP2401HT8P-E1	MMY-MUP1201HT8P-E
MMY-UP6211HT8P-E	MMY-MUP2401HT8P-E1	MMY-MUP2401HT8P-E1	MMY-MUP1401HT8P-E

Three units connected

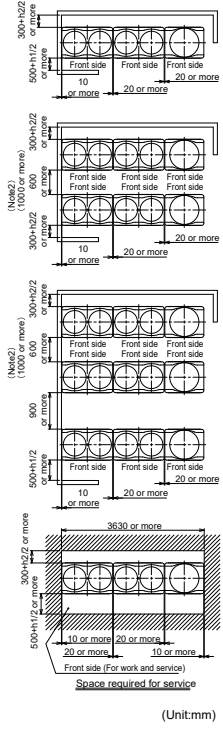
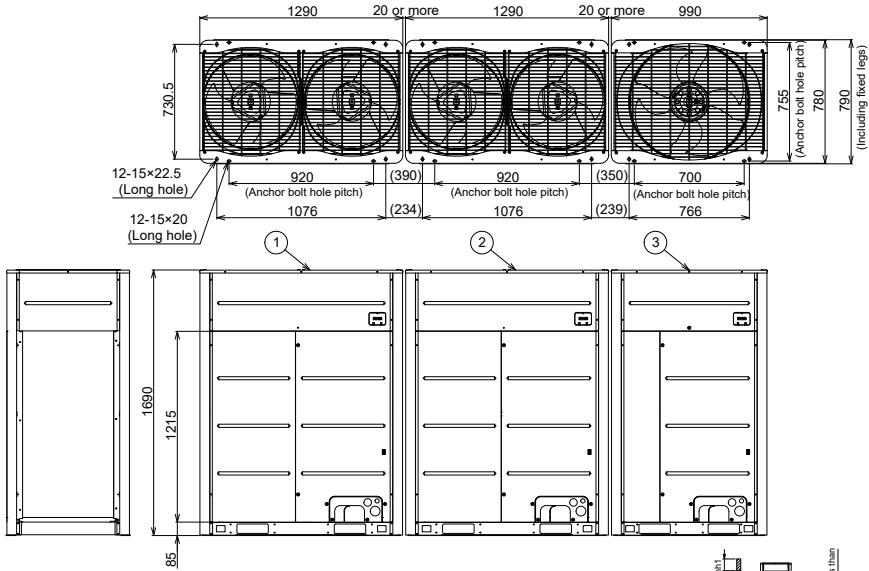

- (Note)
1. If there is an obstacle at the upper side of the outdoor unit, set the top end of the outdoor unit 2000mm apart from the obstacle.
 2. Draw out the pipe procured locally to the front of the outdoor unit horizontally, and keep 500mm or more between the outdoor unit and traversing pipe if placing pipe transversely.
 3. Arrange each outdoor unit in order of its capacity.
(Header unit ① ≥ Follower unit ② ≥ Follower unit ③)

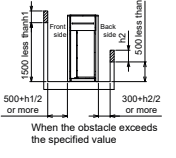

(Unit:mm)

Model	Outdoor unit		
	(1) Header unit	(2) Follower unit	(3) Header unit
MMY-UP6411HT8P-E	MMY-MUP2401HT8P-E1	MMY-MUP2001HT8P-E	MMY-MUP2001HT8P-E
MMY-UP6611HT8P-E	MMY-MUP2401HT8P-E1	MMY-MUP2201HT8P-E	MMY-MUP2001HT8P-E
MMY-UP6811HT8P-E	MMY-MUP2401HT8P-E1	MMY-MUP2401HT8P-E1	MMY-MUP2001HT8P-E
MMY-UP7011HT8P-E	MMY-MUP2401HT8P-E1	MMY-MUP2401HT8P-E1	MMY-MUP2201HT8P-E
MMY-UP7211HT8P-E	MMY-MUP2401HT8P-E1	MMY-MUP2401HT8P-E1	MMY-MUP2401HT8P-E1

Three units connected

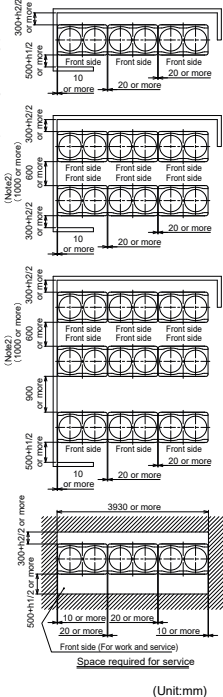
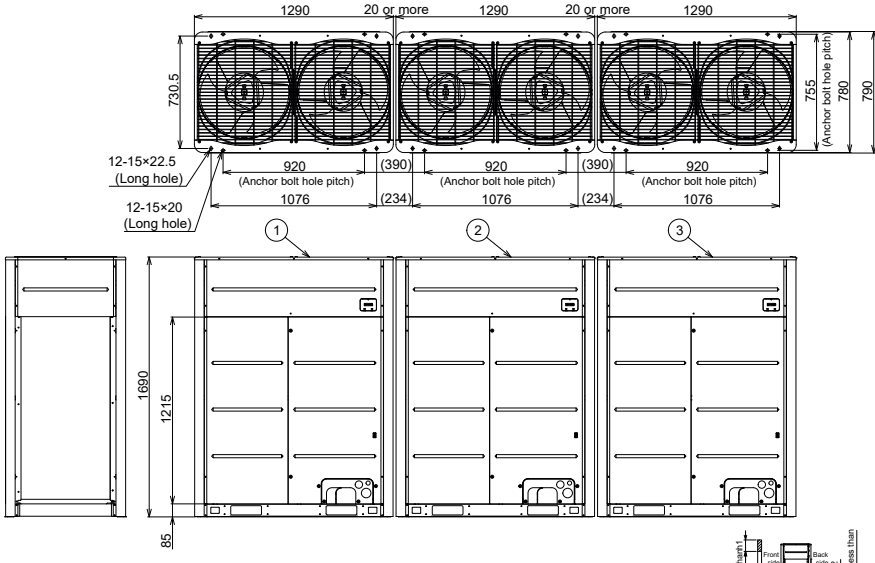

- (Note)
1. If there is an obstacle at the upper side of the outdoor unit, set the top end of the outdoor unit 2000mm apart from the obstacle.
 2. Draw out the pipe procured locally to the front of the outdoor unit horizontally, and keep 500mm or more between the outdoor unit and traversing pipe if placing pipe transversely.
 3. Arrange each outdoor unit in order of its capacity.
(Header unit ① ≥ Follower unit ② ≥ Follower unit ③)

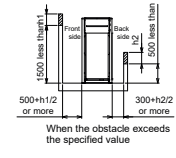

(Unit:mm)

Model	Outdoor unit			
	(1) Header unit	(2) Follower unit	(3) Follower unit	(4) Follower unit
MMY-UP7411HT8P-E	MMY-MUP2401HT8P-E1	MMY-MUP2401HT8P-E1	MMY-MUP1401HT8P-E	MMY-MUP1201HT8P-E
MMY-UP7611HT8P-E	MMY-MUP2401HT8P-E1	MMY-MUP2401HT8P-E1	MMY-MUP1401HT8P-E	MMY-MUP1401HT8P-E

Four units connected

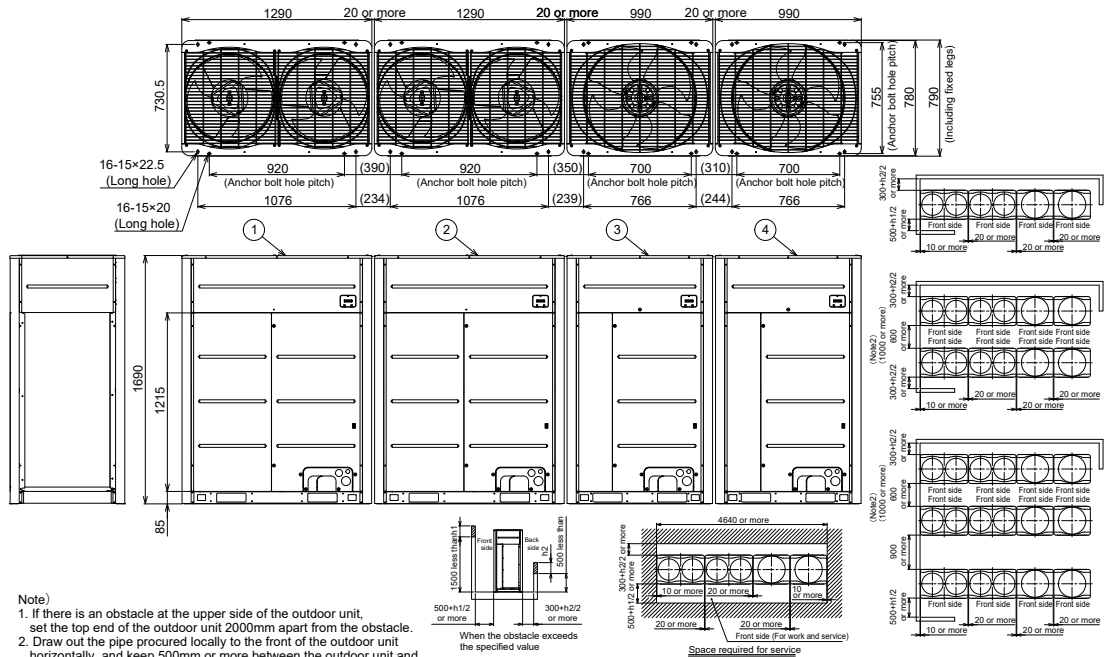

- Note
- If there is an obstacle at the upper side of the outdoor unit, set the top end of the outdoor unit 200mm apart from the obstacle.
 - Draw out the pipe procured locally to the front of the outdoor unit horizontally, and keep 500mm or more between the outdoor unit and traversing pipe if placing pipe transversely.
 - Arrange each outdoor unit in order of its capacity.
(Header unit ① > Follower unit ② > Follower unit ③ > Follower unit ④)

(Unit:mm)

Model	Outdoor unit			
	(1) Header unit	(2) Follower unit	(3) Follower unit	(4) Follower unit
MMY-UP7811HT8P-E	MMY-MUP2401HT8P-E1	MMY-MUP2001HT8P-E	MMY-MUP2001HT8P-E	MMY-MUP1401HT8P-E
MMY-UP8011HT8P-E	MMY-MUP2401HT8P-E1	MMY-MUP2401HT8P-E1	MMY-MUP2001HT8P-E	MMY-MUP1201HT8P-E
MMY-UP8211HT8P-E	MMY-MUP2401HT8P-E1	MMY-MUP2401HT8P-E1	MMY-MUP2001HT8P-E	MMY-MUP1401HT8P-E
MMY-UP8411HT8P-E	MMY-MUP2401HT8P-E1	MMY-MUP2401HT8P-E1	MMY-MUP2401HT8P-E1	MMY-MUP1201HT8P-E
MMY-UP8611HT8P-E	MMY-MUP2401HT8P-E1	MMY-MUP2401HT8P-E1	MMY-MUP2401HT8P-E1	MMY-MUP1401HT8P-E

Four units connected

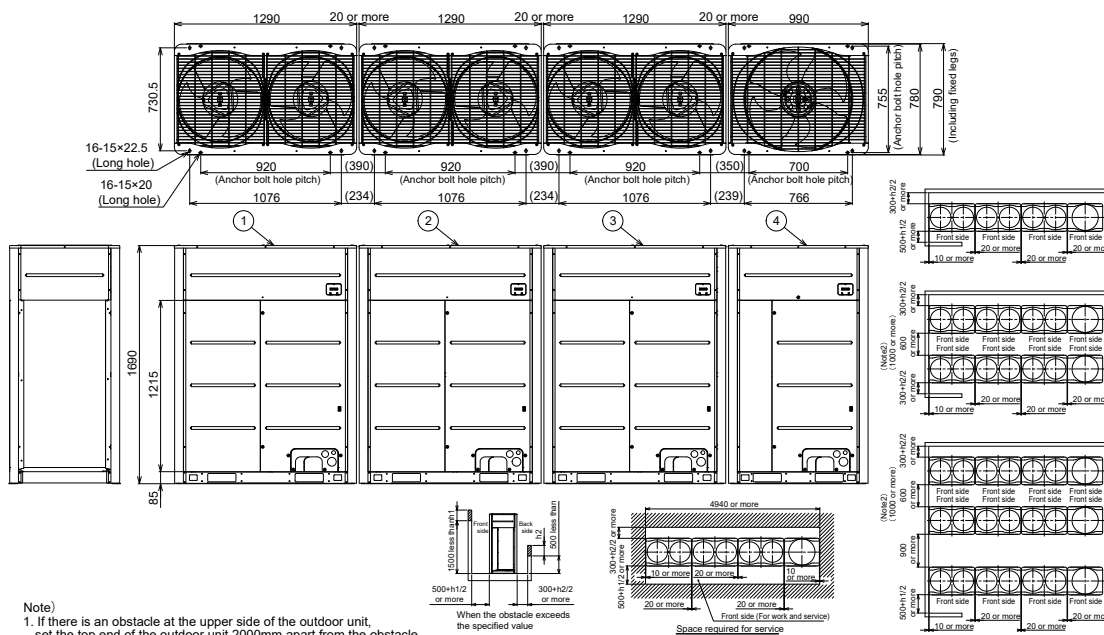

- Note
- If there is an obstacle at the upper side of the outdoor unit, set the top end of the outdoor unit 200mm apart from the obstacle.
 - Draw out the pipe procured locally to the front of the outdoor unit horizontally, and keep 500mm or more between the outdoor unit and traversing pipe if placing pipe transversely.
 - Arrange each outdoor unit in order of its capacity.
(Header unit ① > Follower unit ② > Follower unit ③ > Follower unit ④)

(Unit:mm)

Model	Outdoor unit			
	(1) Header unit	(2) Follower unit	(3) Follower unit	(4) Follower unit
MMY-UP8811HT8P-E	MMY-MUP2401HT8P-E1	MMY-MUP2401HT8P-E1	MMY-MUP2001HT8P-E	MMY-MUP2001HT8P-E
MMY-UP9011HT8P-E	MMY-MUP2401HT8P-E1	MMY-MUP2401HT8P-E1	MMY-MUP2201HT8P-E	MMY-MUP2001HT8P-E
MMY-UP9211HT8P-E	MMY-MUP2401HT8P-E1	MMY-MUP2401HT8P-E1	MMY-MUP2401HT8P-E1	MMY-MUP2001HT8P-E
MMY-UP9411HT8P-E	MMY-MUP2401HT8P-E1	MMY-MUP2401HT8P-E1	MMY-MUP2401HT8P-E1	MMY-MUP2201HT8P-E
MMY-UP9611HT8P-E	MMY-MUP2401HT8P-E1	MMY-MUP2401HT8P-E1	MMY-MUP2401HT8P-E1	MMY-MUP2401HT8P-E1

Four units connected

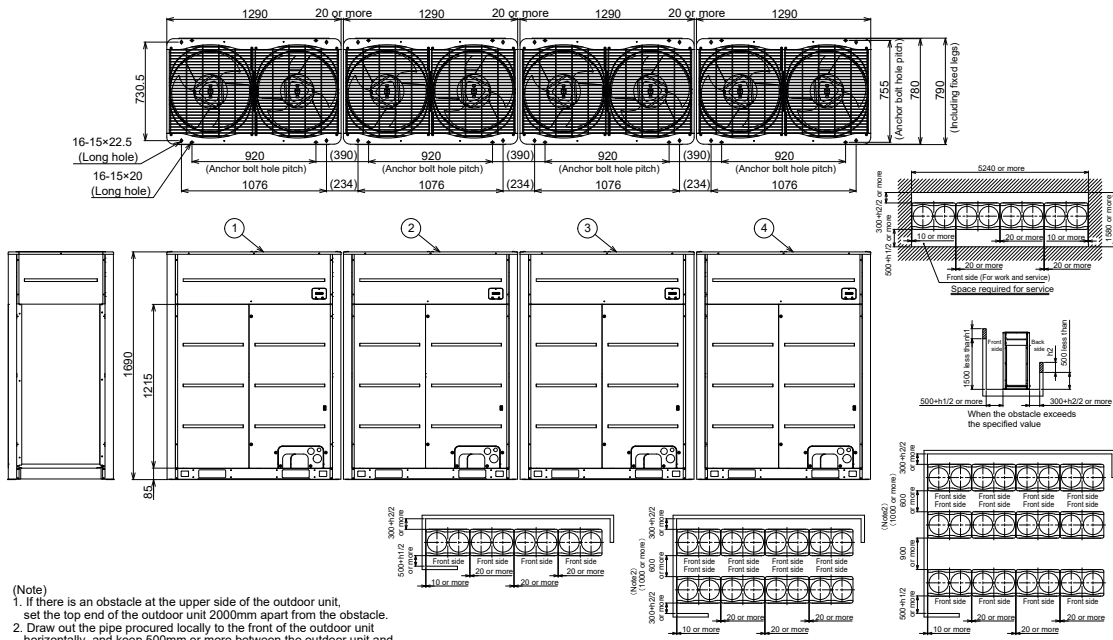

(Note)
 1. If there is an obstacle at the upper side of the outdoor unit, set the top end of the outdoor unit 2000mm apart from the obstacle.
 2. Draw out the pipe procured locally to the front of the outdoor unit horizontally, and keep 500mm or more between the outdoor unit and traversing pipe if placing pipe transversely.
 3. Arrange each outdoor unit in order of its capacity.
 (Header unit ① > Follower unit ② > Follower unit ③ > Follower unit ④)

(Unit:mm)

Model	Outdoor unit				
	(1) Header unit	(2) Follower unit	(3) Follower unit	(4) Follower unit	(5) Follower unit
MMY-UP9811HT8P-E	MMY-MUP2401HT8P-E1	MMY-MUP2401HT8P-E1	MMY-MUP2401HT8P-E1	MMY-MUP1401HT8P-E	MMY-MUP1201HT8P-E
MMY-UP10011HT8P-E	MMY-MUP2401HT8P-E1	MMY-MUP2401HT8P-E1	MMY-MUP2401HT8P-E1	MMY-MUP1401HT8P-E	MMY-MUP1401HT8P-E

Five units connected

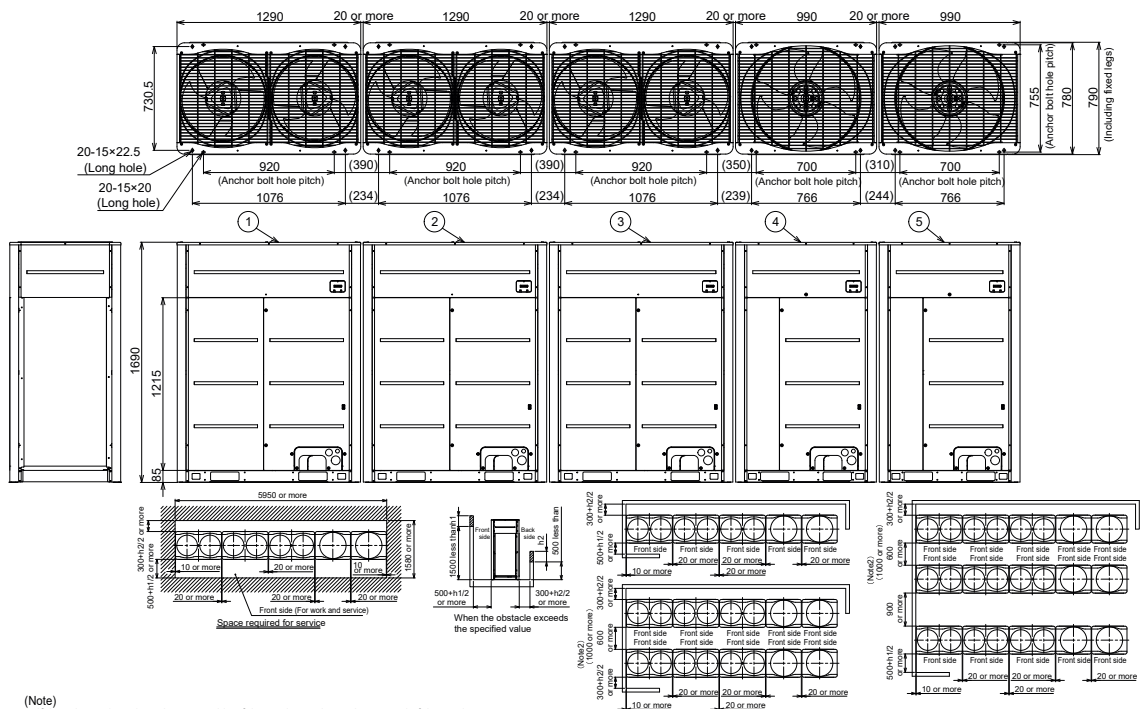

(Note)
 1. If there is an obstacle at the upper side of the outdoor unit, set the top end of the outdoor unit 2000mm apart from the obstacle.
 2. Draw out the pipe procured locally to the front of the outdoor unit horizontally, and keep 500mm or more between the outdoor unit and traversing pipe if placing pipe transversely.
 3. Arrange each outdoor unit in order of its capacity.
 (Header unit ① > Follower unit ② > Follower unit ③ > Follower unit ④ > Follower unit ⑤)

(Unit:mm)

Model	Outdoor unit				
	(1) Header unit	(2) Follower unit	(3) Follower unit	(4) Follower unit	(5) Follower unit
MMY-UP10211HT8P-E	MMY-MUP2401HT8P-E1	MMY-MUP2401HT8P-E1	MMY-MUP2001HT8P-E	MMY-MUP2001HT8P-E	MMY-MUP1401HT8P-E
MMY-UP10411HT8P-E	MMY-MUP2401HT8P-E1	MMY-MUP2401HT8P-E1	MMY-MUP2401HT8P-E1	MMY-MUP2401HT8P-E1	MMY-MUP1201HT8P-E
MMY-UP10611HT8P-E	MMY-MUP2401HT8P-E1	MMY-MUP2401HT8P-E1	MMY-MUP2401HT8P-E1	MMY-MUP2001HT8P-E	MMY-MUP1401HT8P-E
MMY-UP10811HT8P-E	MMY-MUP2401HT8P-E1	MMY-MUP2401HT8P-E1	MMY-MUP2401HT8P-E1	MMY-MUP2401HT8P-E1	MMY-MUP1201HT8P-E
MMY-UP11011HT8P-E	MMY-MUP2401HT8P-E1	MMY-MUP2401HT8P-E1	MMY-MUP2401HT8P-E1	MMY-MUP2401HT8P-E1	MMY-MUP1401HT8P-E

Five units connected

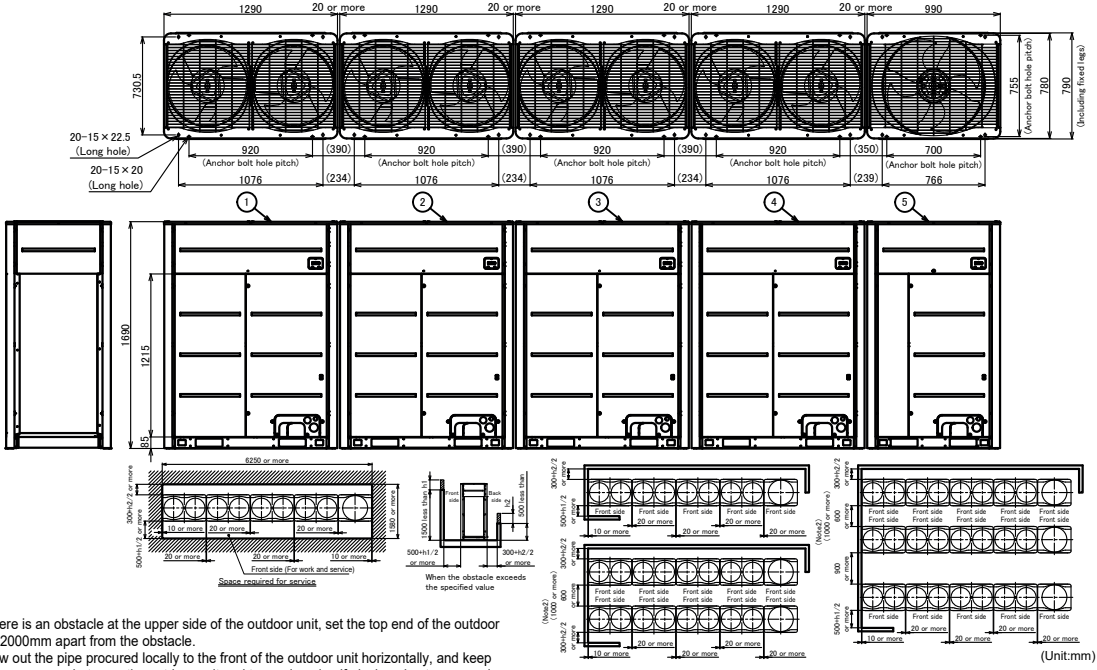

- Note
1. If there is an obstacle at the upper side of the outdoor unit, set the top end of the outdoor unit 2000mm apart from the obstacle.
 2. Draw out the pipe procured locally to the front of the outdoor unit horizontally, and keep 500mm or more between the outdoor unit and traversing pipe if placing pipe transversely.
 3. Arrange each outdoor unit in order of its capacity.
(Header unit ① ≥ Follower unit ② ≥ Follower unit ③ ≥ Follower unit ④ ≥ Follower unit ⑤)

Model	Outdoor unit				
	(1) Header unit	(2) Follower unit	(3) Follower unit	(4) Follower unit	(5) Follower unit
MMY-UP11211HT8P-E	MMY-MUP2401HT8P-E1	MMY-MUP2401HT8P-E1	MMY-MUP2401HT8P-E1	MMY-MUP2001HT8P-E	MMY-MUP2001HT8P-E
MMY-UP11411HT8P-E	MMY-MUP2401HT8P-E1	MMY-MUP2401HT8P-E1	MMY-MUP2401HT8P-E1	MMY-MUP2201HT8P-E	MMY-MUP2001HT8P-E
MMY-UP11611HT8P-E	MMY-MUP2401HT8P-E1	MMY-MUP2401HT8P-E1	MMY-MUP2401HT8P-E1	MMY-MUP2401HT8P-E1	MMY-MUP2001HT8P-E
MMY-UP11811HT8P-E	MMY-MUP2401HT8P-E1	MMY-MUP2401HT8P-E1	MMY-MUP2401HT8P-E1	MMY-MUP2401HT8P-E1	MMY-MUP2201HT8P-E
MMY-UP12011HT8P-E	MMY-MUP2401HT8P-E1	MMY-MUP2401HT8P-E1	MMY-MUP2401HT8P-E1	MMY-MUP2401HT8P-E1	MMY-MUP2401HT8P-E1

Five units connected

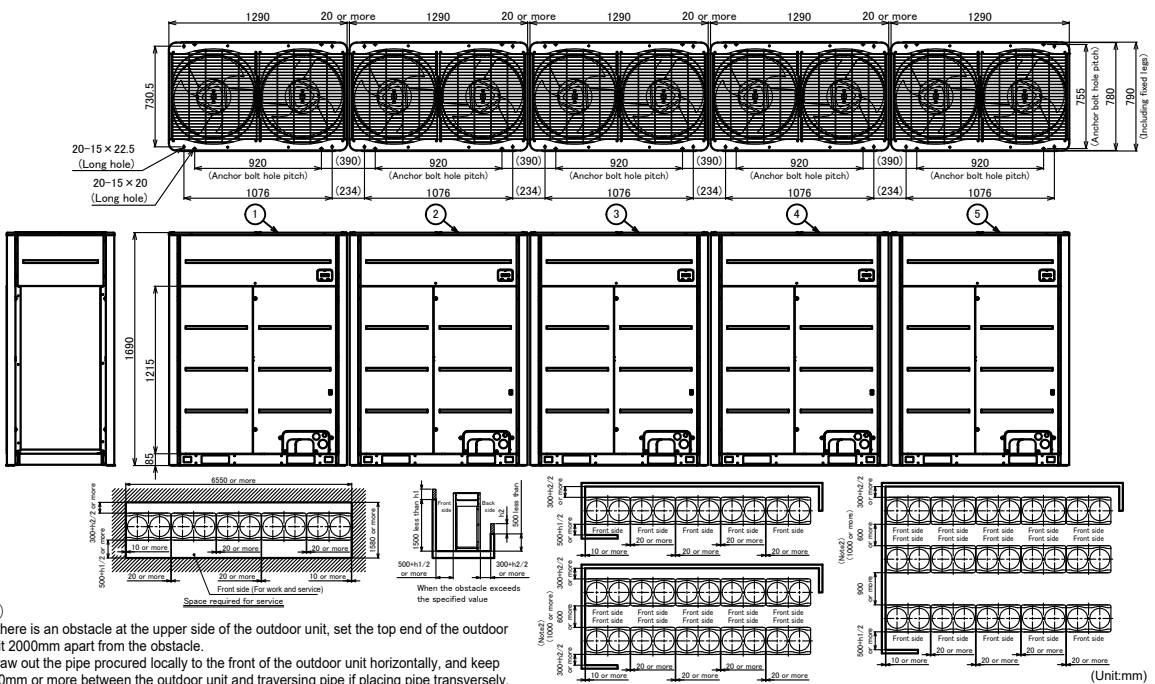

- Note
1. If there is an obstacle at the upper side of the outdoor unit, set the top end of the outdoor unit 2000mm apart from the obstacle.
 2. Draw out the pipe procured locally to the front of the outdoor unit horizontally, and keep 500mm or more between the outdoor unit and traversing pipe if placing pipe transversely.
 3. Arrange each outdoor unit in order of its capacity.
(Header unit ① ≥ Follower unit ② ≥ Follower unit ③ ≥ Follower unit ④ ≥ Follower unit ⑤)

5-3. Center of gravity

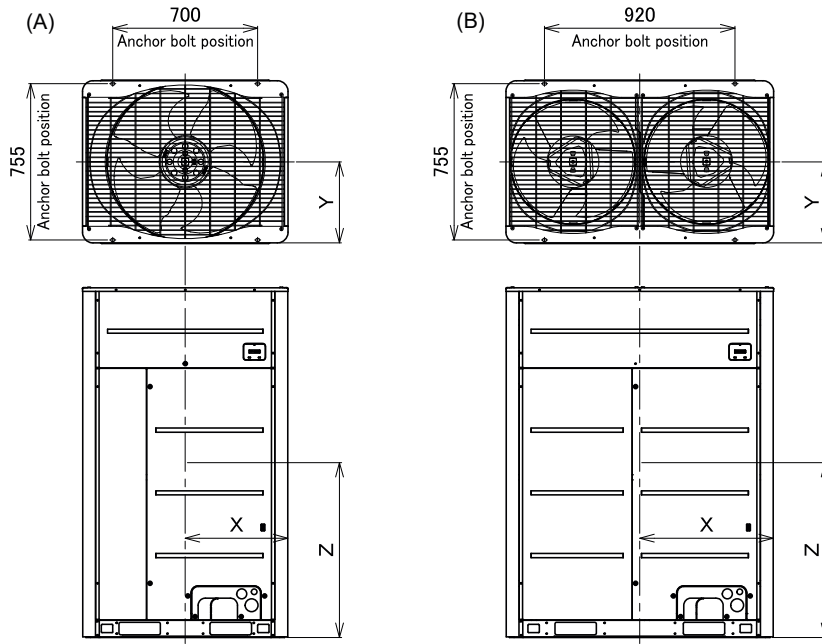

(Unit : mm)

No.	HP	Model type	X (mm)	Y (mm)	Z (mm)	Mass (kg)
(A)	08	MMY-MUP0801HT8P-E	500	400	675	228
	10	MMY-MUP1001HT8P-E	500	400	675	228
	12	MMY-MUP1201HT8P-E	500	400	675	228
	14	MMY-MUP1401HT8P-E	500	400	675	228
(B)	16	MMY-MUP1601HT8P-E	650	370	605	312
	18	MMY-MUP1801HT8P-E	650	370	605	312
	20	MMY-MUP2001HT8P-E	650	370	605	334
	22	MMY-MUP2201HT8P-E	650	360	680	356
	24	MMY-MUP2401HT8P-E1	650	360	680	356

5-4. Branch header / branch joint

• Branch header

RBM-HY1043E, HY1083E, HY2043E, HY2083E

Gas side

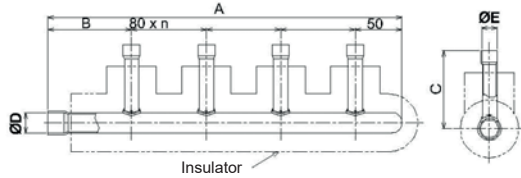

Liquid side

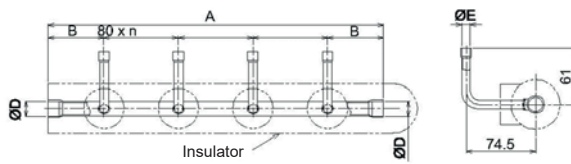

								(Unit : mm)
Model		A	B	C	øD	øE	n	Accessory socket Qty
RBM-HY1043E	Gas side	380	90	83.6	22.2	15.9	3	⑥x 4, ⑨x 4, ⑭x 1, ⑱x 1, ⑳x 1
	Liquid side	360	60	-	15.9	9.5	3	①x 4, ⑥x 1, ⑨x 1
RBM-HY1083E	Gas side	700	90	83.6	22.2	15.9	7	⑥x 8, ⑨x 8, ⑭x 1, ⑱x 1, ⑳x 1
	Liquid side	680	60	-	15.9	9.5	7	①x 8, ⑥x 1, ⑨x 1
RBM-HY2043E	Gas side	385.5	95.5	89.3	31.8	15.9	3	⑥x 2, ⑨x 2, ⑳x 1, ㉑x 1
	Liquid side	360	60	-	15.9	9.5	3	①x 2
RBM-HY2083E	Gas side	705.5	95.5	89.3	31.8	15.9	7	⑥x 7, ⑨x 7, ⑳x 1, ㉑x 1
	Liquid side	680	60	-	15.9	9.5	7	①x 7

• Y-shape branch joint

RBM-BY55E, BY105E, BY205E, BY305E, BY405E

Gas side

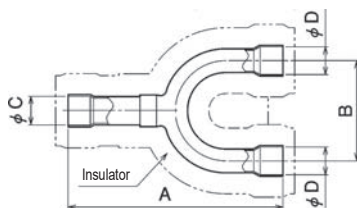

Liquid side

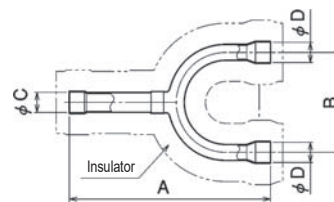

						(Unit:mm)
Model		A	B	øC	øD	Accessory socket Qty
RBM-BY55E	Gas side	160	80	15.9	15.9	⑨x 1, ⑤①x 2, ⑨①x 2
	Liquid side	130	70	9.5	9.5	①x 2
RBM-BY105E	Gas side	170	80	22.2	22.2	⑭x 2, ⑳x 2, ⑨①x 1
	Liquid side	160	80	15.9	15.9	⑥x 1, ⑨x 1, ⑨①x 1, ⑨②x 1
RBM-BY205E	Gas side	200	80	31.8	28.6	⑱x 1, ⑳x 1, ④③x 2, ⑤③x 1, ⑤④x 1, ⑨①x 1
	Liquid side	160	80	15.9	15.9	⑨x 1, ⑤①x 2, ⑨②x 1
RBM-BY305E	Gas side	220	80	38.1	38.1	④③x 1, ⑥①x 3, ⑥②x 2, ⑦①x 2, ⑦⑤x 1, ⑨①x 1
	Liquid side	170	80	22.2	22.2	⑨②x 1, ⑨④x 3
RBM-BY405E	Gas side	254	80	44.6	38.1	④③x 1, ⑥①x 2, ⑥②x 2, ⑦①x 1, ⑦⑤x 1, ⑨①x 1, ⑨①x 1, ⑩①x 2
	Liquid side	170	80	22.2	22.2	⑨②x 1, ⑨④x 1, ⑱x 1, ⑥⑨x 2

• **Branching joint for connection of outdoor units (Set of three kinds of joint)**
RBM-BT14E

Gas side

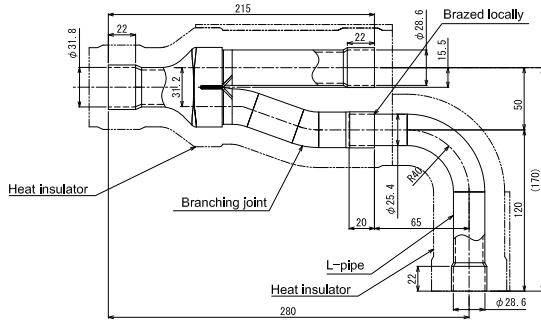

Liquid side

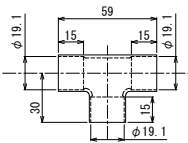

Balance pipe

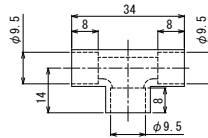

	Accessory socket Qty
Gas side	②⑦ x 1, ④③ x 2, ⑤⑨ x 1, ②① x 2
Liquid side	⑩ x 3, ⑬ x 1, ⑦ x 2

RBM-BT24E

Gas side

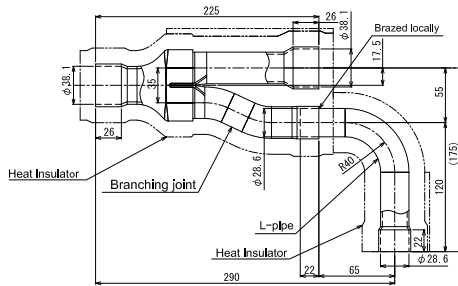

Liquid side

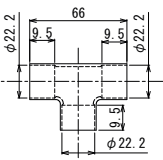

Balance pipe

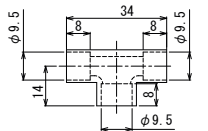

	Accessory socket Qty
Gas side	④③ x 1, ⑥① x 2, ⑥② x 2, ⑦① x 1, ⑦③ x 1, ⑤⑧ x 1, ⑦④ x 1
Liquid side	⑭ x 3, ⑱ x 3, ⑥⑤ x 2, ⑥⑥ x 1

RBM-BT34E

Gas side

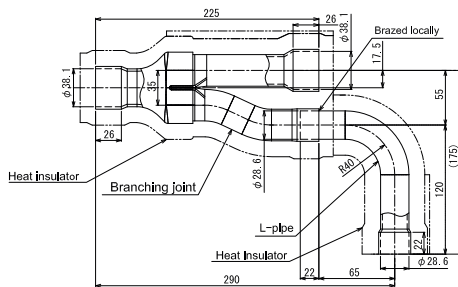

Liquid side

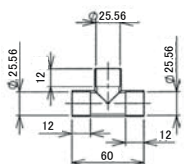

	Accessory socket Qty
Gas side	④③ x 1, ⑥② x 2, ⑦① x 1, ⑦③ x 1, ⑤⑧ x 1, ⑦④ x 1, ⑨① x 2, ⑩① x 2
Liquid side	⑭ x 1, ⑱ x 1, ⑥⑤ x 1

(Unit : mm)

• Accessory socket

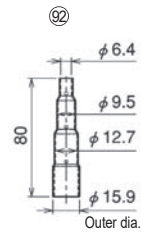
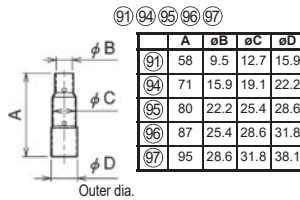
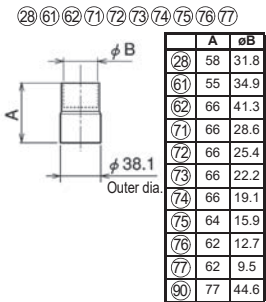
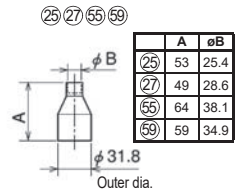
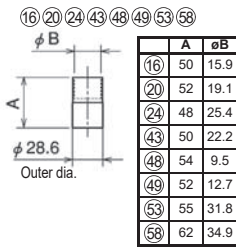
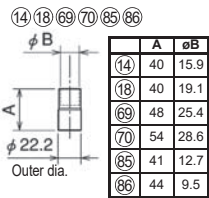
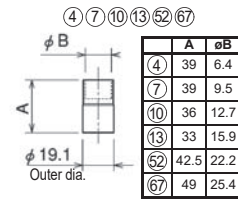
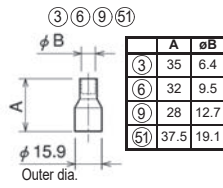
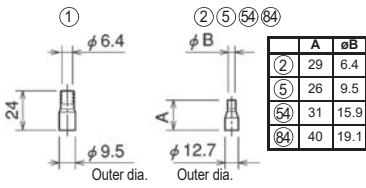

Closure tube

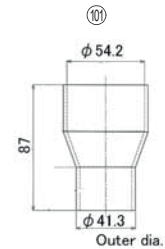
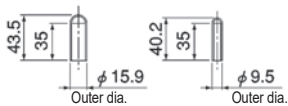

(Unit : mm)

5-5. Refrigerant cycle diagram

Model : MMY-MUP0801HT8P-E, MMY-MUP1001HT8P-E, MMY-MUP1201HT8P-E, MMY-MUP1401HT8P-E

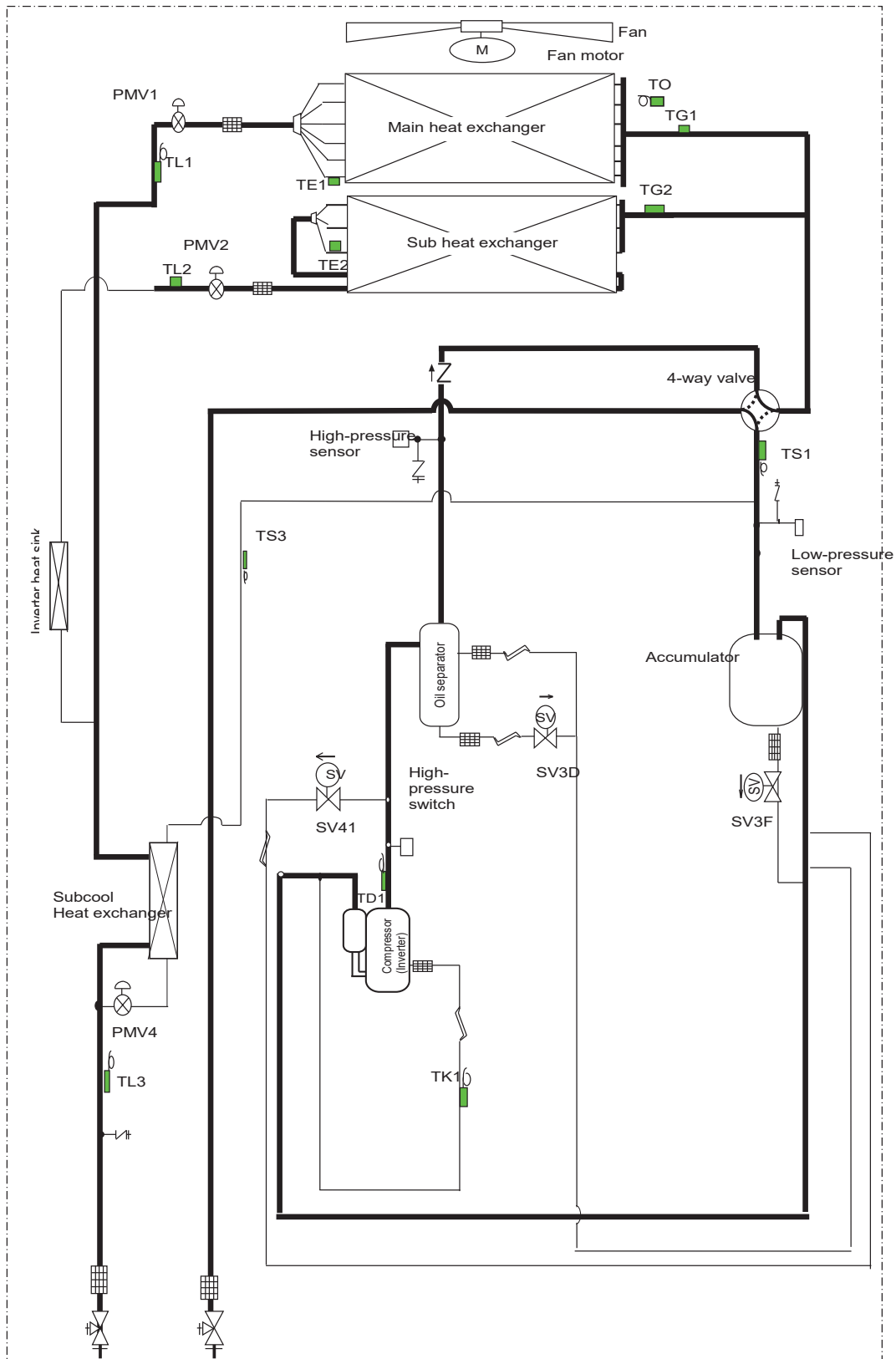

Liquid side Service valve Gas side Service valve

Symbol						
Solenoid valve	Capillary tube	Check valve	Check joint	Strainer	Temperature sensor	Distributor

Model : MMY-MUP1601HT8P-E, MMY-MUP1801HT8P-E, MMY-MUP2001HT8P-E

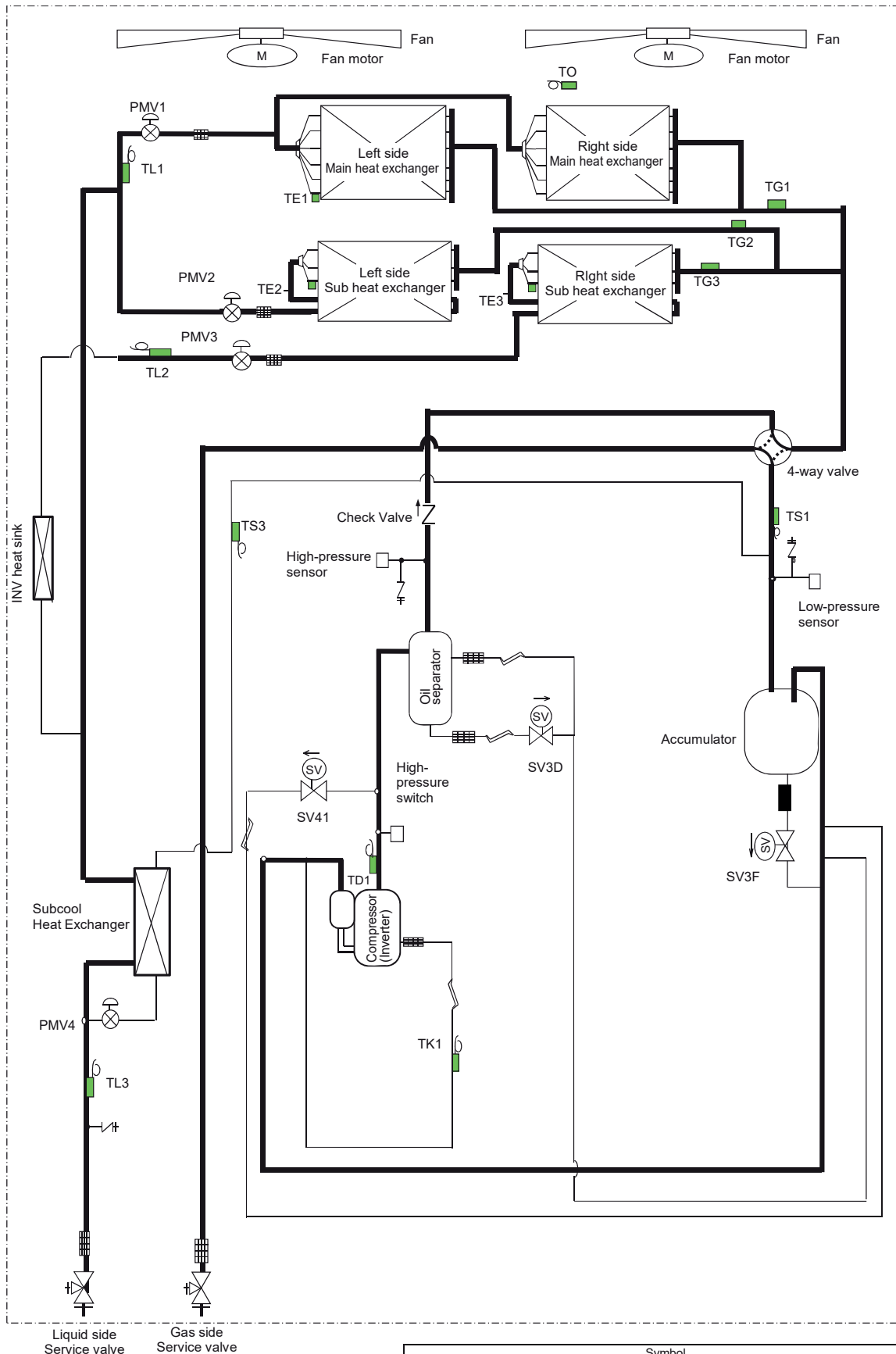

Symbol						
Solenoid valve	Capillary tube	Check valve	Check joint	Strainer	Temperature sensor	Distributor

Model : MMY-MUP2201HT8P-E, MMY-MUP2401HT8P-E1

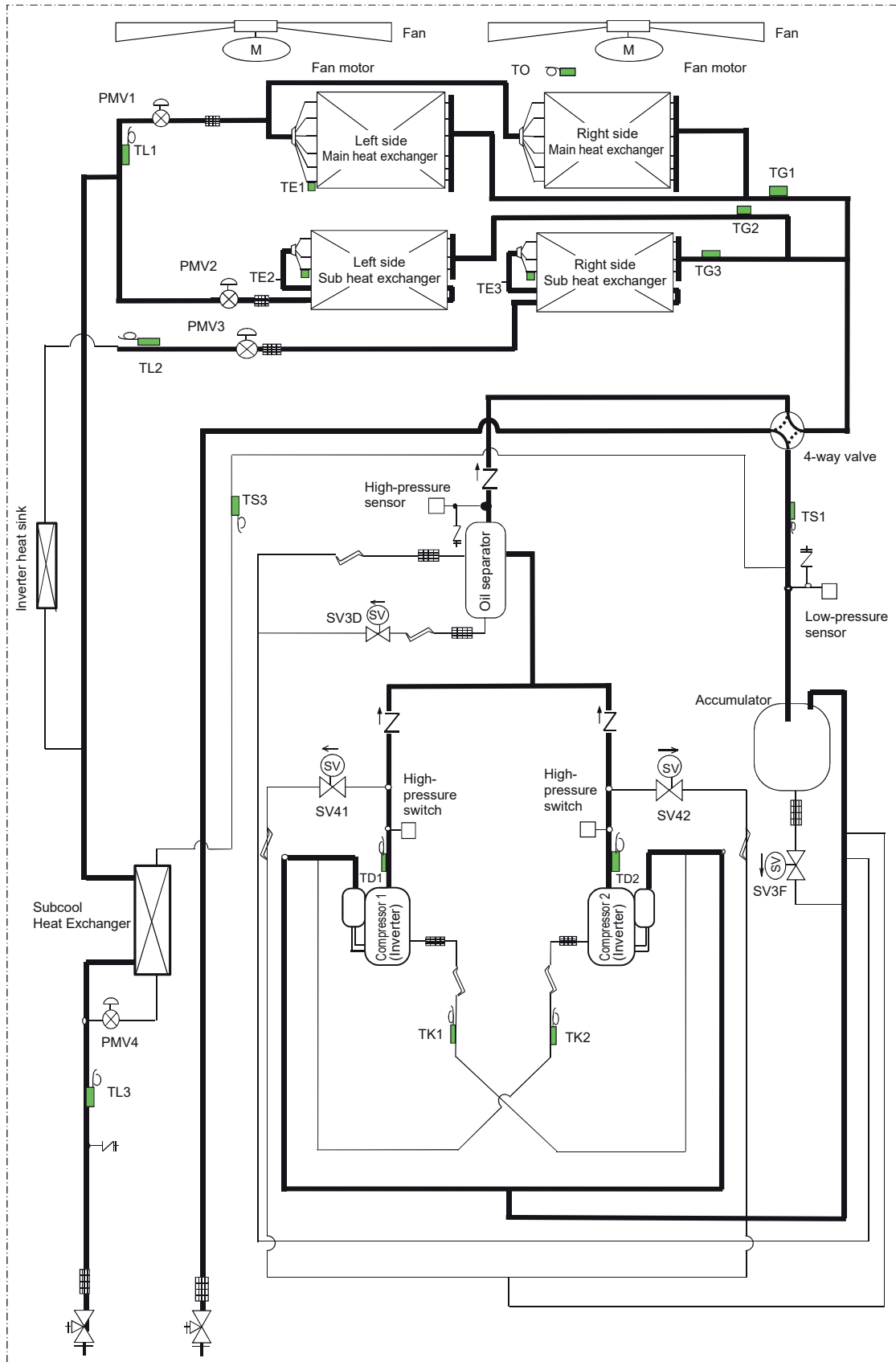

Liquid side Service valve
Gas side Service valve

Symbol						
Solenoid valve	Capillary tube	Check valve	Check joint	Strainer	Temperature sensor	Distributor

5-6. Wiring diagram

Model : MMY-MUP0801HT8P-E, MMY-MUP1001HT8P-E, MMY-MUP1201HT8P-E, MMY-MUP1401HT8P-E

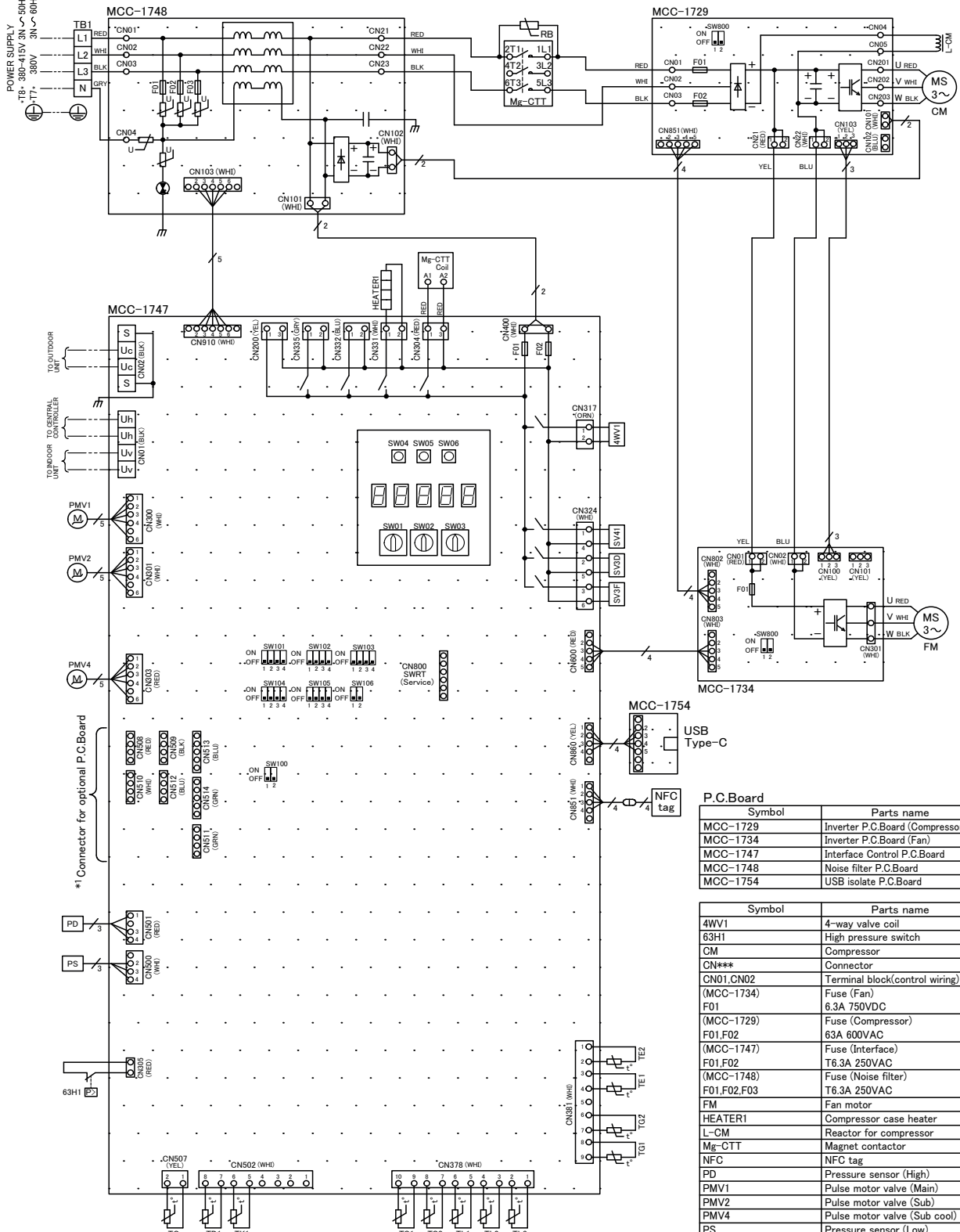

*1 The installation of the optional board is up to four pieces.

	Field wiring
	Protective earth
	Terminal block
	Terminal
	Connector
	P.C. Board

Color indication	
RED	RED
WHI	WHITE
YEL	YELLOW
BLU	BLUE
BLK	BLACK
GRY	GRAY
ORN	ORANGE
GRN	GREEN

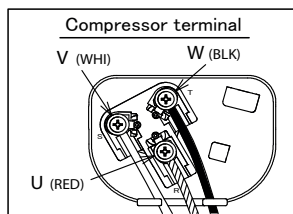

Symbol	Parts name
MCC-1729	Inverter P.C. Board (Compressor)
MCC-1734	Inverter P.C. Board (Fan)
MCC-1747	Interface Control P.C. Board
MCC-1748	Noise filter P.C. Board
MCC-1754	USB isolate P.C. Board

Symbol	Parts name
4WV1	4-way valve coil
63H1	High pressure switch
CM	Compressor
CN***	Connector
CN01, CN02	Terminal block (control wiring)
(MCC-1734) F01	Fuse (Fan) 6.3A 750VDC
(MCC-1729) F01, F02	Fuse (Compressor) 6.3A 600VAC
(MCC-1747) F01, F02	Fuse (Interface) T6.3A 250VAC
(MCC-1748) F01, F02, F03	Fuse (Noise filter) T6.3A 250VAC
FM	Fan motor
HEATER1	Compressor case heater
L-CM	Reactor for compressor
Mg-CTT	Magnet contactor
NFC	NFC tag
PD	Pressure sensor (High)
PMV1	Pulse motor valve (Main)
PMV2	Pulse motor valve (Sub)
PMV4	Pulse motor valve (Sub cool)
PS	Pressure sensor (Low)
RB	Rush current protect resistor
SV3D, SV3F, SV41	2-way valve coil
SW01, SW02, SW03	Rotary switch
SW04, SW05, SW06	Push button switch
SW100, SW101, SW102, SW103	Dip switch
SW104, SW105, SW106	Dip switch
TB1	Terminal block (Power supply)
TD1	Discharge temp. sensor
TE1, TE2	Heat exchange temp. sensor
TG1, TG2	Gas temp. sensor
TK1	Oil temp. sensor
TL1, TL2, TL3	Liquid temp. sensor
TO	Air temp. sensor
TS1, TS3	Suction temp. sensor

Model : MMY-MUP1601HT8P-E, MMY-MUP1801HT8P-E, MMY-MUP2001HT8P-E

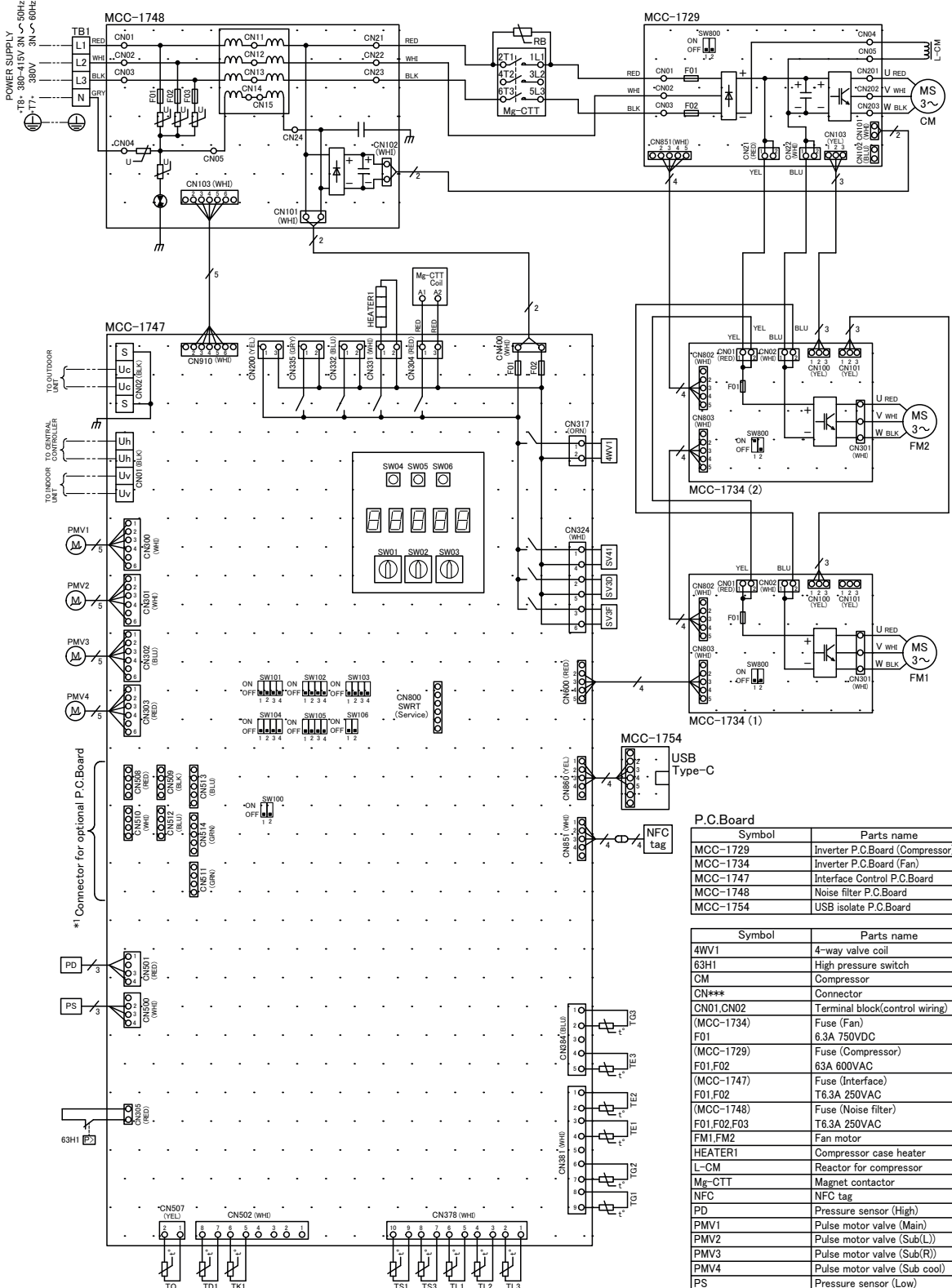

*1 Connector for optional P.C.Board

*1 The installation of the optional board is up to four pieces.

Symbol	Parts name
MCC-1729	Inverter P.C.Board (Compressor)
MCC-1734	Inverter P.C.Board (Fan)
MCC-1747	Interface Control P.C.Board
MCC-1748	Noise filter P.C.Board
MCC-1754	USB isolate P.C.Board

Symbol	Parts name
4WV1	4-way valve coil
63H1	High pressure switch
CM	Compressor
CN***	Connector
CN01,CN02	Terminal block(control wiring)
(MCC-1734)	Fuse (Fan)
F01	6.3A 750VDC
(MCC-1729)	Fuse (Compressor)
F01,F02	63A 600VAC
(MCC-1747)	Fuse (Interface)
F01,F02	T6.3A 250VAC
(MCC-1748)	Fuse (Noise filter)
F01,F02,F03	T6.3A 250VAC
FM1,FM2	Fan motor
HEATER1	Compressor case heater
L-CM	Reactor for compressor
Mg-CTT	Magnet contactor
NFC	NFC tag
PD	Pressure sensor (High)
PMV1	Pulse motor valve (Main)
PMV2	Pulse motor valve (Sub(L))
PMV3	Pulse motor valve (Sub(R))
PMV4	Pulse motor valve (Sub cool)
PS	Pressure sensor (Low)
RB	Rush current protect resistor
SV3D,SV3F,SV41	2-way valve coil
SW01,SW02,SW03	Rotary switch
SW04,SW05,SW06	Push button switch
SW100,SW101,SW102,SW103	Dip switch
SW104,SW105,SW106	Dip switch
TB1	Terminal block(Power supply)
TD1	Discharge temp. sensor
TE1,TE2,TE3	Heat exchange temp. sensor
TG1,TG2,TG3	Gas temp. sensor
TK1	Oil temp. sensor
TL1,TL2,TL3	Liquid temp. sensor
TO	Air temp. sensor
TS1,TS3	Suction temp. sensor

---	Field wiring
⊕	Protective earth
□	Terminal block
○	Terminal
⊞	Connector
⋯	P.C.Board

Color indication	
RED	RED
WH	WHITE
YEL	YELLOW
BLU	BLUE
BLK	BLACK
GRY	GRAY
ORN	ORANGE
GRN	GREEN

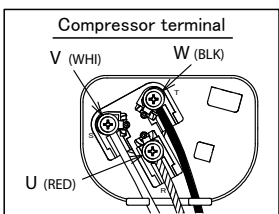

Model : MMY-MUP2201HT8P-E, MMY-MUP2401HT8P-E1

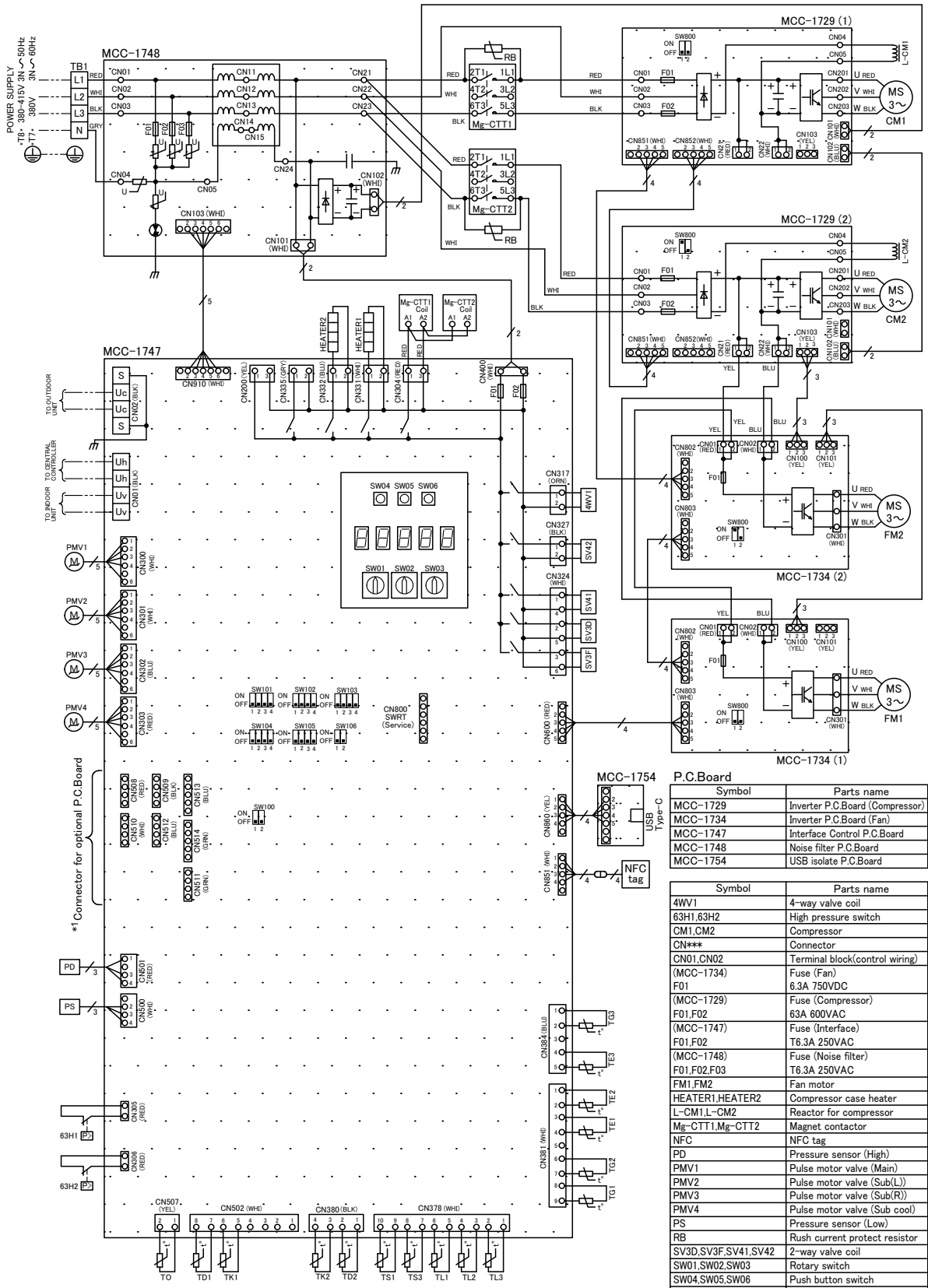

*1 The installation of the optional board is up to four pieces.

	Field wiring
	Protective earth
	Terminal block
	Terminal
	Connector
	P.C. Board

Color indication	
RED	RED
WHI	WHITE
YEL	YELLOW
BLU	BLUE
BLK	BLACK
GRY	GRAY
ORN	ORANGE
GRN	GREEN

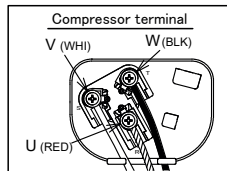

Symbol	Parts name
MCC-1729	Inverter P.C. Board (Compressor)
MCC-1734	Inverter P.C. Board (Fan)
MCC-1747	Interface Control P.C. Board
MCC-1748	Noise filter P.C. Board
MCC-1754	USB isolate P.C. Board

Symbol	Parts name
4WV1	4-way valve coil
63H1,63H2	High pressure switch
CM1,CM2	Compressor
CN***	Connector
CN01,CN02	Terminal block(control wiring)
(MCC-1734)	Fuse (Fan)
F01	6.3A 750VDC
(MCC-1729)	Fuse (Compressor)
F01,F02	63A 600VAC
(MCC-1747)	Fuse (Interface)
F01,F02	T6.3A 250VAC
(MCC-1748)	Fuse (Noise filter)
F01,F02,F03	T6.3A 250VAC
FM1,FM2	Fan motor
HEATER1,HEATER2	Compressor case heater
L-CM1,L-CM2	Reactor for compressor
Mg-CTT1,Mg-CTT2	Magnet contactor
NFC	NFC tag
PD	Pressure sensor (High)
PMV1	Pulse motor valve (Main)
PMV2	Pulse motor valve (Sub(L))
PMV3	Pulse motor valve (Sub(R))
PMV4	Pulse motor valve (Sub cool)
PS	Pressure sensor (Low)
RB	Rush current protect resistor
SV3D,SV3F,SV41,SV42	2-way valve coil
SW01,SW02,SW03	Rotary switch
SW04,SW05,SW06	Push button switch
SW100,SW101,SW102,SW103	Dip switch
SW104,SW105,SW106	Terminal block(Power supply)
TB1	Terminal block(Power supply)
TD1,TD2	Discharge temp. sensor
TE1,TE2,TE3	Heat exchange temp. sensor
TG1,TG2,TG3	Gas temp. sensor
TK1,TK2	Oil temp. sensor
TL1,TL2,TL3	Liquid temp. sensor
TO	Air temp. sensor
TS1,TS3	Suction temp. sensor

5-7. Connecting diagram

Single unit connected

Model : MMY-MUP***1HT8P-E / E1

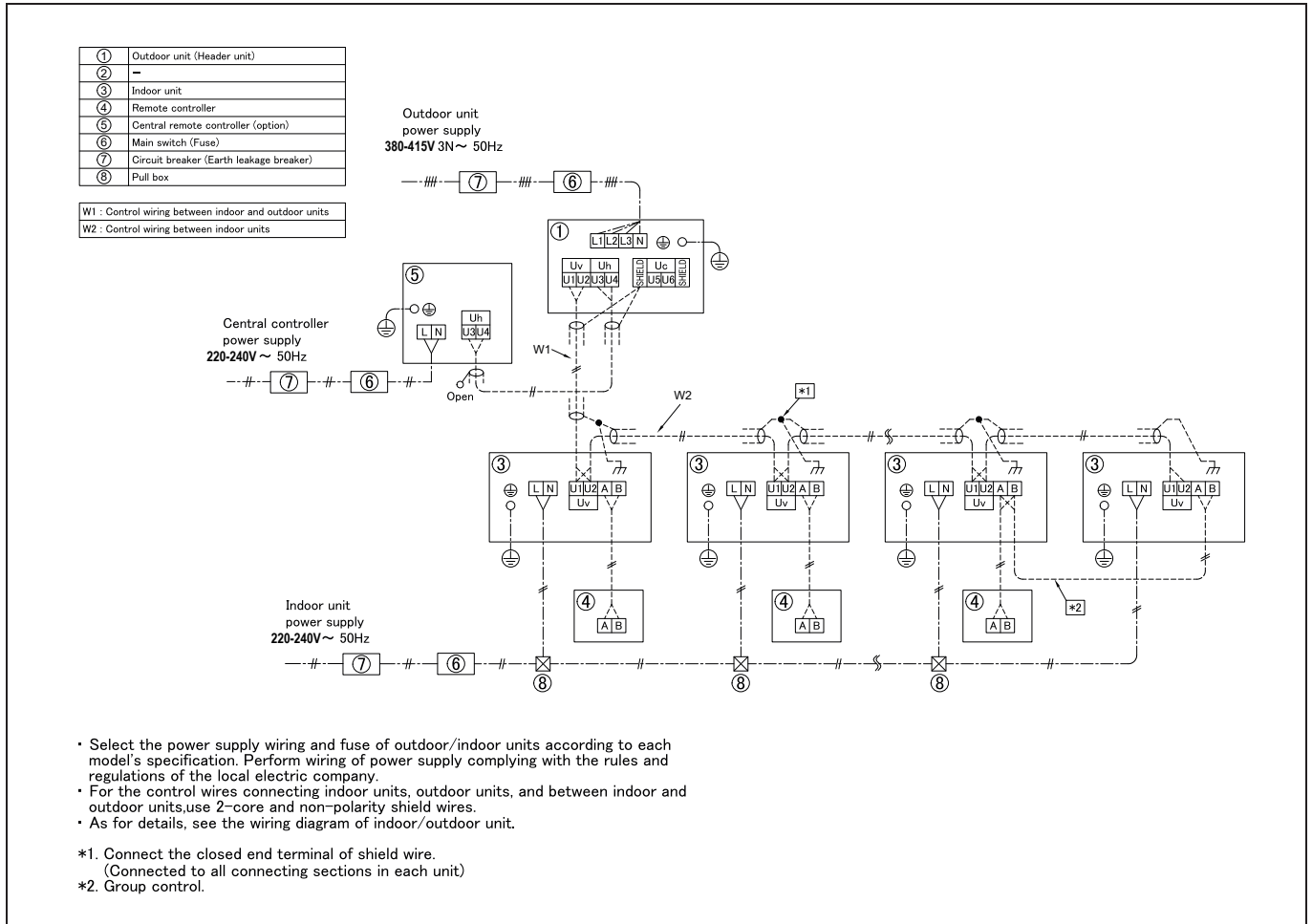

Two units connected
Model : MMY-UP*1HT8P-E / E1**

①	Outdoor unit (Header unit)
②	Outdoor unit (Follower unit)
③	Indoor unit
④	Remote controller
⑤	Central remote controller (option)
⑥	Main switch (Fuse)
⑦	Circuit breaker (Earth leakage breaker)
⑧	Pull box

W1 : Control wiring between indoor and outdoor units
 W2 : Control wiring between indoor units
 W3 : Control wiring between outdoor units

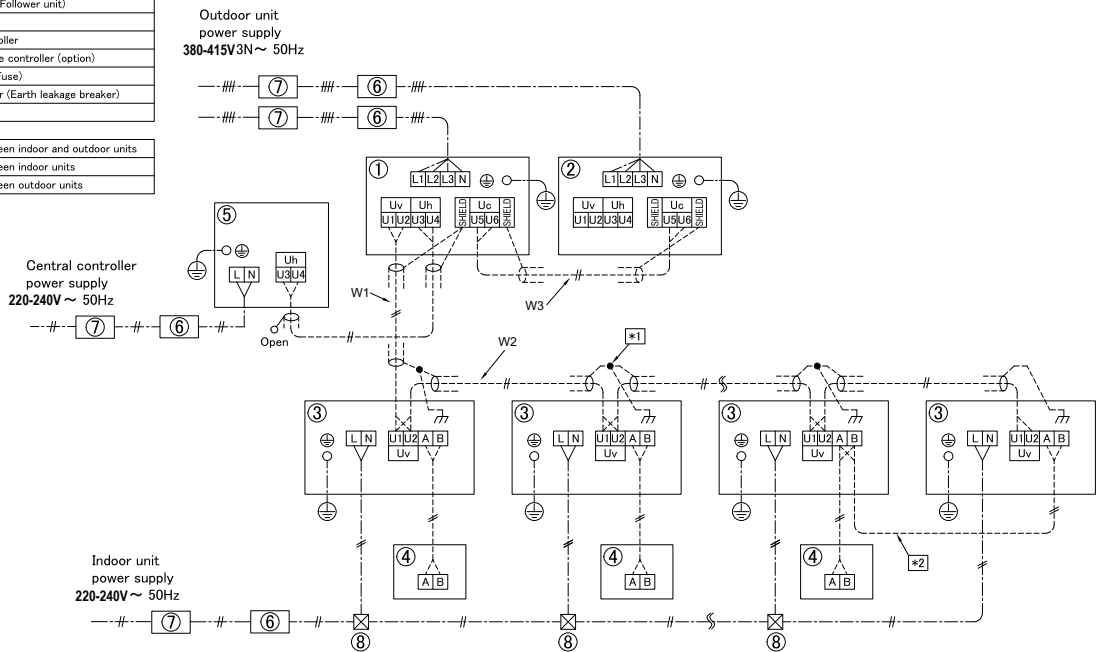

- Select the power supply wiring and fuse of outdoor/indoor units according to each model's specification. Perform wiring of power supply complying with the rules and regulations of the local electric company.
- For the control wires connecting indoor units, outdoor units, and between indoor and outdoor units, use 2-core and non-polarity shield wires.
- As for details, see the wiring diagram of indoor/outdoor unit.

- *1. Connect the closed end terminal of shield wire.
 (Connected to all connecting sections in each unit)
- *2. Group control.

Three units connected

Model : MMY-UP***1HT8P-E / E1

①	Outdoor unit (Header unit)
②	Outdoor unit (Follower unit)
③	Indoor unit
④	Remote controller
⑤	Central remote controller (option)
⑥	Main switch (Fuse)
⑦	Circuit breaker (Earth leakage breaker)
⑧	Pull box

W1 : Control wiring between indoor and outdoor units
 W2 : Control wiring between indoor units
 W3 : Control wiring between outdoor units

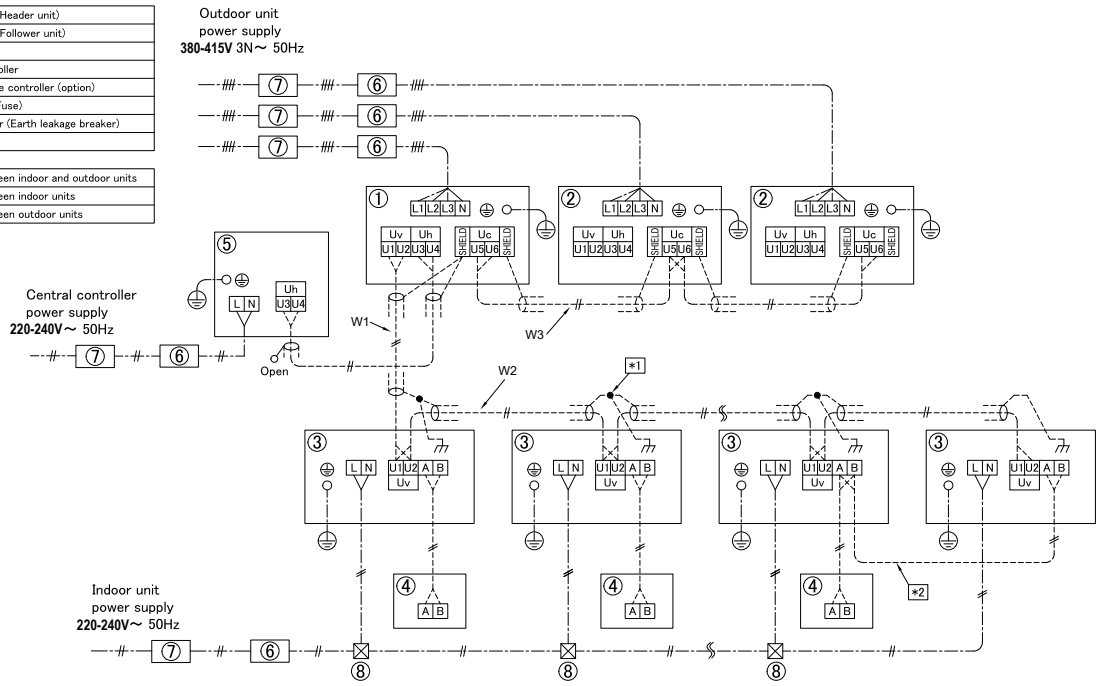

- Select the power supply wiring and fuse of outdoor/indoor units according to each model's specification. Perform wiring of power supply complying with the rules and regulations of the local electric company.
 - For the control wires connecting indoor units, outdoor units, and between indoor and outdoor units, use 2-core and non-polarity shield wires.
 - As for details, see the wiring diagram of indoor/outdoor unit.
- *1. Connect the closed end terminal of shield wire.
 (Connected to all connecting sections in each unit)
- *2. Group control.

Four units connected

Model : MMY-UP*1HT8P-E / E1**

①	Outdoor unit (Header unit)
②	Outdoor unit (Follower unit)
③	Indoor unit
④	Remote controller
⑤	Central remote controller (option)
⑥	Main switch (Fuse)
⑦	Circuit breaker (Earth leakage breaker)
⑧	Pull box

W1 : Control wiring between indoor and outdoor units
 W2 : Control wiring between indoor units
 W3 : Control wiring between outdoor units

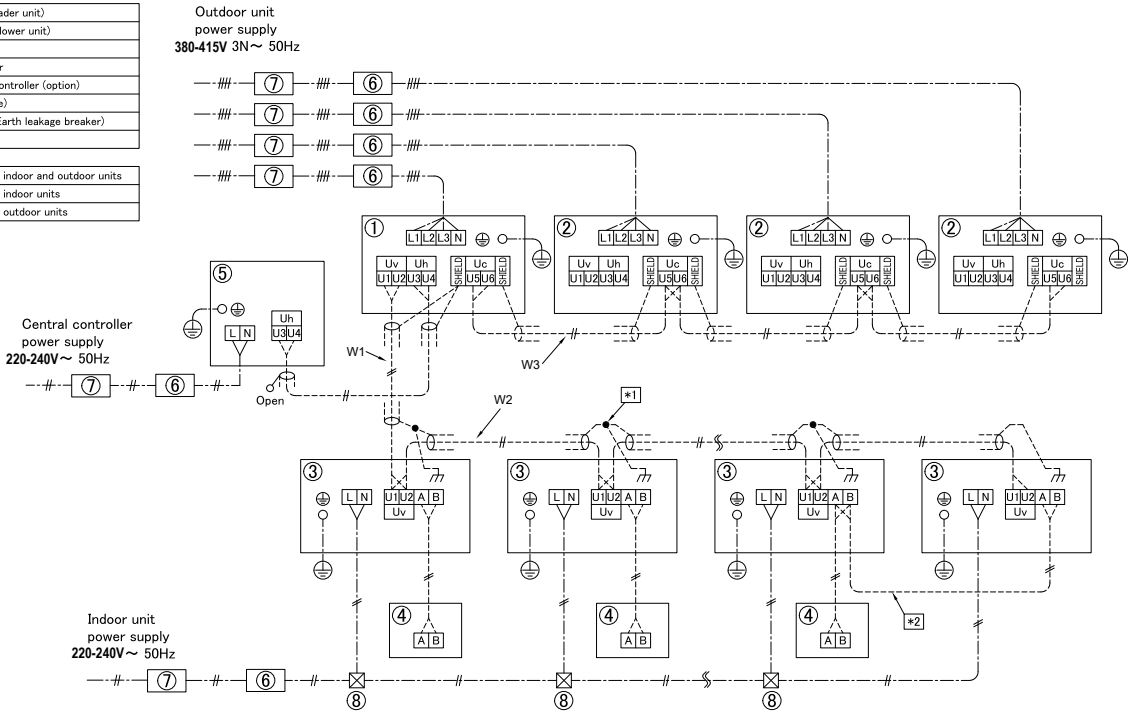

- Select the power supply wiring and fuse of outdoor/indoor units according to each model's specification. Perform wiring of power supply complying with the rules and regulations of the local electric company.
- For the control wires connecting indoor units, outdoor units, and between indoor and outdoor units, use 2-core and non-polarity shield wires.
- As for details, see the wiring diagram of indoor/outdoor unit.

*1. Connect the closed end terminal of shield wire.
 (Connected to all connecting sections in each unit)
 *2. Group control.

Five units connected

Model : MMY-UP***1HT8P-E / E1

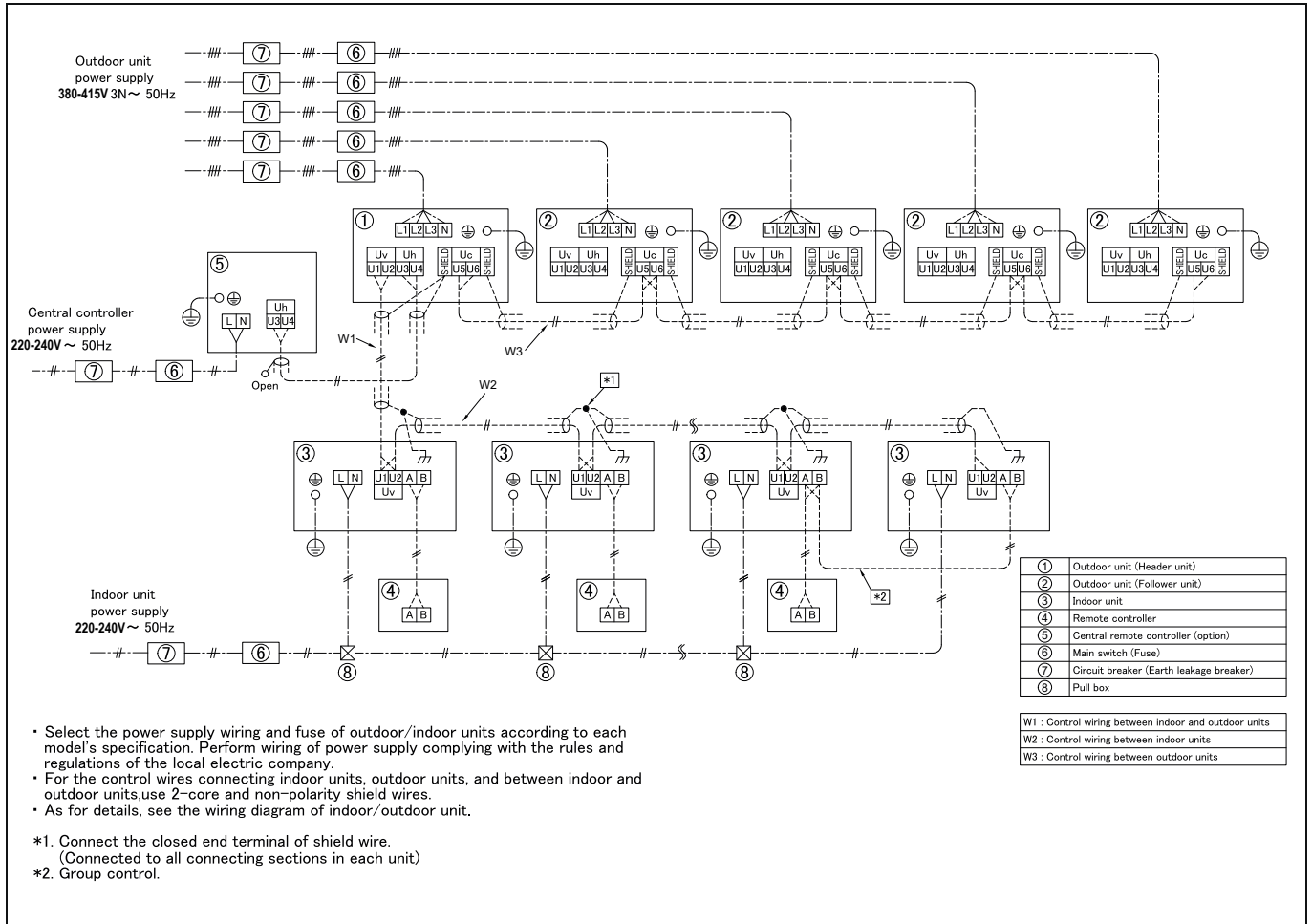

5-8. Applied control for Outdoor Unit

The outdoor fan high static pressure support and priority operation mode setting (cooling / heating / number of units / or priority indoor unit) functions are made available by setting relevant switches provided on the interface P.C. board of the outdoor unit.

5-8-1. Outdoor Fan High Static Pressure Shift

Purpose/characteristics

This function is used when connecting a duct to the discharge port of an outdoor unit (as part of, for example, unit installation on the floor by floor installation).

Setup

Change the outdoor DN code [019] setting to 0001.

0000 : Usual 0001 : High Static Pressure Operation

This function must be enabled with every discharge duct connected outdoor unit both of the header and follower units.

Specification

Increase the speed of the propeller fan units on the outdoor fan to allow the installation of a duct with a maximum external static pressure not greater than specified in the table below. If a discharge duct with a resistance greater than 15 Pa (1.5 mmAq) is to be used, enable this function. The maximum external static pressures of base units are shown below (Table 1). In the case of combined use of multiple outdoor units, set all the units to the same maximum external static pressure as the one with the lowest pressure (see Table 2).

Table 1: Maximum External Static Pressure of Base Outdoor Units

MMY-MUP	0801HT8P-E	1001HT8P-E	1201HT8P-E	1401HT8P-E	1601HT8P-E	1801HT8P-E	2001HT8P-E	2201HT8P-E	2401HT8P-E1
Pa	80	80	80	80	80	80	80	80	80
m ³ /h	9900	10500	11700	11880	15300	16800	15900	16500	16500

(*) Calculate duct resistance from outdoor unit air flow.

Table 2: Maximum External Static Pressure for Combined Use of Base Units

Basic models

System	Combination				Maximum external static pressure
HP	HP				Pa
8	8				80
10	10				80
12	12				80
14	14				80
16	16				80
18	18				80
20	20				80
22	22				80
24	24				80
26	14	12			80
28	14	14			80
30	18	12			80
32	20	12			80
34	20	14			80
36	24	12			80
38	24	14			80
40	20	20			80
42	24	18			80
44	24	20			80
46	24	22			80
48	24	24			80
50	24	14	12		80
52	24	14	14		80
54	20	20	14		80
56	24	20	12		80
58	24	20	14		80
60	24	24	12		80
62	24	24	14		80
64	24	20	20		80
66	24	22	20		80
68	24	24	20		80
70	24	24	22		80

System	Combination					Maximum external static pressure
72	24	24	24			80
74	24	24	14	12		80
76	24	24	14	14		80
78	24	24	20	12		80
80	24	24	20	12		80
82	24	24	20	14		80
84	24	24	24	12		80
86	24	24	24	14		80
88	24	24	20	20		80
90	24	24	22	20		80
92	24	24	24	20		80
94	24	24	24	22		80
96	24	24	24	24		80
98	24	24	24	14	12	80
100	24	24	24	14	14	80
102	24	24	20	20	14	80
104	24	24	24	20	12	80
106	24	24	24	20	14	80
108	24	24	24	24	12	80
110	24	24	24	24	14	80
112	24	24	24	20	20	80
114	24	24	24	22	20	80
116	24	24	24	24	20	80
118	24	24	24	24	22	80
120	24	24	24	24	24	80

5-8-2. Priority Operation Mode Setting

Purpose/characteristics

This function allows switching between priority cooling and priority heating. Four patterns of priority operation mode setting are available as shown in the table below. Select a suitable priority mode according to the needs of the customer.

Setup

CAUTION

In the case of the priority indoor unit mode, it is necessary to set up the specific indoor unit chosen for priority operation (a single unit only).

(1) Outdoor unit setup method (header unit)

Outdoor DN Code (O.DN) Setting	Operation
O.DN [18] = 0	Priority heating (factory default)
O.DN [18] = 1	Priority cooling
O.DN [18] = 2	Priority operation based on No. of units in operation (priority given to the operation mode with the largest share of units in operation)
O.DN [18] = 3	Priority indoor unit (priority given to the operation mode of the specific indoor unit set up for priority operation)

(2) Indoor unit setup method for priority indoor unit mode

The setting can be changed only when the system is at rest. (Be sure to turn off the system prior to this operation.)

Indoor unit setup method for priority indoor unit mode

The setting can be changed only when the system is at rest. (Be sure to turn off the system prior to this operation.)

1 Push and hold menu button and [▽] setting button simultaneously for 10 seconds or more.

(If 2 or more indoor units are controlled in a group, the first indicated UNIT No. is that of the head unit.)

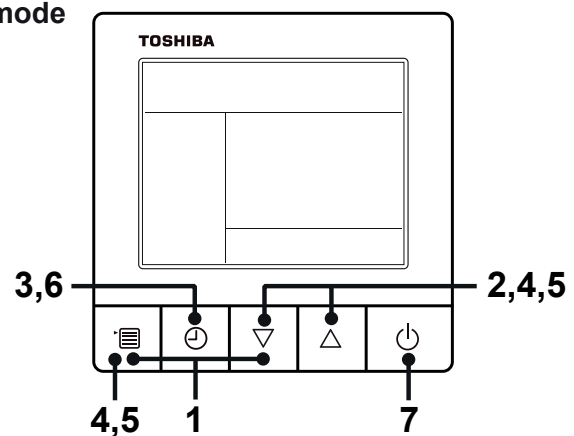
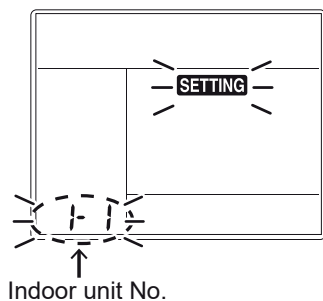

2 Each time [▽] [△] setting button is pushed, indoor unit numbers in the group control change cyclically. Select the indoor unit to change settings for. (The fan and louvers of the selected indoor unit are activated.)

3 Push the Timer off button.

4 Push the menu button to make Code No. flash. Change Code No. To 04 with [▽][△] setting button.

5 Push the menu button to make Set data [****] flash. Use the [▽] [△] buttons to select the SET DATA 0001. Priority set 0001 No priority set 0000

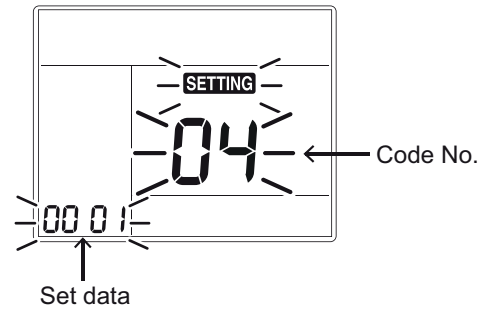

6 Push the Timer off button.

(When the display changes from [— —] to Set data [****] flashing, the setup is completed.)

7 When all the settings have been completed, push ON/OFF button to determine the settings. " **SETTING** " flashes and then the display content disappears and the air conditioner enters the normal stop mode. (The remote controller is unavailable while " **SETTING** " is flashing.)

NOTE

Priority can be given to only one indoor unit. If more than one indoor unit is accidentally set to priority, an error code (L05 or L06: Duplicated in door unit priority setting) will be displayed.

All units displaying L05 have been set to 0001 (priority). Keep the unit to which priority should be given as it is, and change the value back to 0000 (no priority) for all the rest.

Error code	Description
L05	Duplicated indoor unit priority setting (The unit is set to 0001.)
L06	Duplicated indoor unit priority setting (The unit is set to 0000.)

5-9. Optional printed circuit board (PCB) of outdoor unit

Optional control P.C. boards provide access to a range of functions as listed below.

No.	Function	Outdoor unit for control P.C. board Connection	Control P.C. board be used			Outdoor unit interface P.C. board setting*				
			TCB-PCDM4E	TCB-PCMO4E	TCB-PCIN4E	Connector No.	DIP SW No.	Bit ON	Outdoor DN Code (O.DN)	
1	Power peak-cut Control (Standard)	Threshold capacity setting	Header unit	✓	-	-	CN513 (blue)	-	-	[009] = 0 (factory default)
	Power peak-cut Control (Standard)	Threshold power consumption setting	Header unit	✓	-	-	CN513 (blue)	-	-	[009] = 1
	Power peak-cut Control (For one input function)	Threshold capacity setting	Header unit	✓	-	-	CN513 (blue)	SW105	1	[009] = 0 (factory default)
	Power peak-cut Control (For one input function)	Threshold power consumption setting	Header unit	✓	-	-	CN513 (blue)	SW105	1	[009] = 1
2	Power peak-cut Control (Enhanced Function)	Threshold capacity setting	Header unit	✓	-	-	CN513 (blue)	SW105	2	[009] = 0 (factory default)
	Power peak-cut Control (Enhanced Function)	Threshold power consumption setting	Header unit	✓	-	-	CN513 (blue)	SW105	2	[009] = 1
3	Snowfall fan Control		Header unit	-	✓	-	CN509 (black)	-	-	-
4	External master ON/OFF Control		Header unit	-	✓	-	CN512 (blue)	-	-	-
5	Night operation (Sound reduction) Control		Header unit	-	✓	-	CN508 (red)	-	-	-
6	Operation Mode Selection Control		Header unit	-	✓	-	CN510 (white)	-	-	[008] = 0 (factory default)
	Operation Mode Selection Control (forced choice)		Header unit	-	✓	-	CN510 (white)	-	-	[008] = 1
7	Error/Operation output		Header unit	-	-	✓	CN511 (green)	-	-	-
8	Compressor Operation Output		Individual outdoor unit	-	-	✓	CN514 (green)	-	-	[012] = 0 (factory default)
9	Operating Rate Output		Header unit	-	-	✓	CN514 (green)	-	-	[012] = 1

To limit a maximum power, set the outdoor unit O.DN code to [009]=1, and set the criteria value of a maximum power consumption with O.DN code [00A], [00B], [00C] and [00D]. Input the values for both cooling and heating.

Outdoor unit DN Code (O.DN) [00C], [00D]

Criteria value setting for a maximum cooling power

(e.g.) When the maximum standard value of cooling power consumption is set as 19.35 kW = 19.35kW

Outdoor unit DN Code (O.DN)	[00C]	[00D]
Value	19	35

Outdoor unit DN Code (O.DN) [00A], [00B]

Criteria value setting for a maximum heating power

(e.g.) When the maximum standard value of heating power consumption is set as 14.00 kW = 14.00kW

Outdoor unit DN Code (O.DN)	[00A]	[00B]
Value	14	00

Layout of Outdoor Unit Interface P.C. Board

* DIP switch settings vary from function to function.

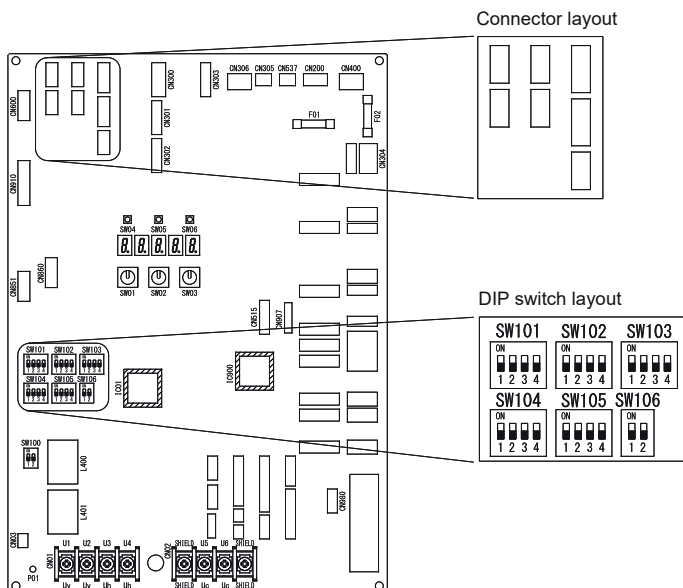

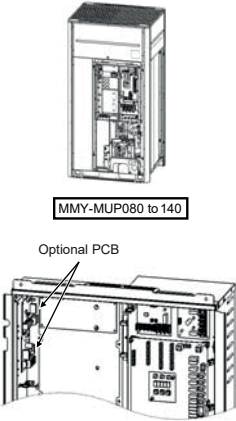
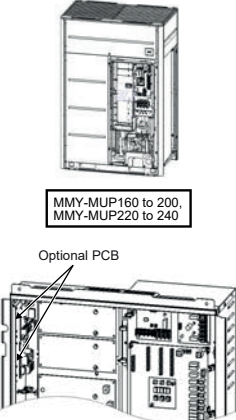
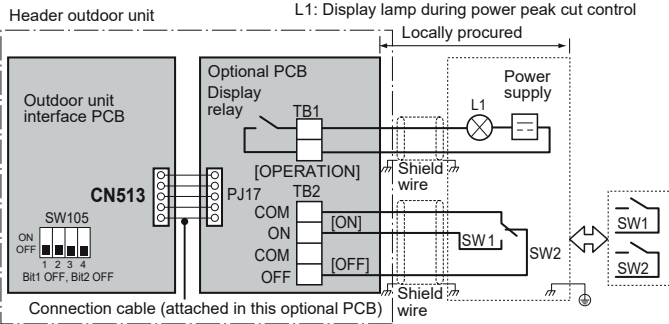
Model name	Appearance	Function																																																																		
TCB-PCDM4E	 <p>Size: 71 x 85 (mm)</p>	<p>[1] Power peak-cut Control</p> <ul style="list-style-type: none"> Purpose: Limiting air conditioning performance with external signals and decreasing the peak power consumption. Feature The upper limit capacity of the outdoor unit is restricted based on the outdoor power peak selected setting. <p>Standard Specifications (Wiring example)</p>																																																																		
	<p>Application</p>  <p>MMY-MUP080 to 140</p> <p>Optional PCB</p>  <p>MMY-MUP160 to 200, MMY-MUP220 to 240</p> <p>Optional PCB</p> <p>(max. number installed: 1pc)</p> <p>* Install the optional PCB in the outdoor header unit.</p>	 <p>Header outdoor unit</p> <p>L1: Display lamp during power peak cut control</p> <p>Locally procured</p> <p>Power supply</p> <p>Shield wire</p> <p>For SW1 and SW2, be sure to provide no-voltage contacts for each terminal. The input signals of SW1 and SW2 may be pulse input (100 msec or more) or continuous make. Do not turn on [SW1] and [SW2] simultaneously.</p> <p>[2-stage switching] < SW105 bit1 OFF, bit2 OFF ></p> <table border="1" data-bbox="564 1088 1485 1279"> <thead> <tr> <th rowspan="3"></th> <th colspan="3">Optional PCB</th> <th colspan="4">Outdoor unit interface PCB</th> </tr> <tr> <th colspan="2">Input</th> <th>Display relay</th> <th colspan="2">SW105</th> <th colspan="2">Outdoor DN Code [00E]</th> </tr> <tr> <th>SW1</th> <th>SW2</th> <th>(L1)</th> <th>Bit1</th> <th>Bit2</th> <th>factory default [00E]=15</th> <th>[00E]=0~10</th> </tr> </thead> <tbody> <tr> <td>Input demand OFF signal to release the demand</td> <td>OFF</td> <td>ON</td> <td>OFF</td> <td>OFF</td> <td>OFF</td> <td>100% (normal operation)</td> <td>100% (normal operation)</td> </tr> <tr> <td>Input demand ON signal to control the demand</td> <td>ON</td> <td>OFF</td> <td>ON</td> <td>OFF</td> <td>OFF</td> <td>0% (forced stop)</td> <td>Approx. X% (50%~100%) (upper limit regulated)</td> </tr> </tbody> </table> <p>* The upper limit Z% can be regulated with the outdoor DN Code (O.DN) [00E]</p> <table border="1" data-bbox="564 1312 948 1697"> <thead> <tr> <th>Outdoor unit DN Code (O.DN) [00E]</th> <th>X</th> </tr> </thead> <tbody> <tr><td>0</td><td>100%</td></tr> <tr><td>1</td><td>95%</td></tr> <tr><td>2</td><td>90%</td></tr> <tr><td>3</td><td>85%</td></tr> <tr><td>4</td><td>80%</td></tr> <tr><td>5</td><td>75%</td></tr> <tr><td>6</td><td>70%</td></tr> <tr><td>7</td><td>65%</td></tr> <tr><td>8</td><td>60%</td></tr> <tr><td>9</td><td>55%</td></tr> <tr><td>10</td><td>50%</td></tr> <tr><td>15 (factory default)</td><td>0% (forced stop)</td></tr> </tbody> </table> <p>Note1: Specifications of display relay contact</p> <ul style="list-style-type: none"> The terminal for display output ([Operation] terminal) must satisfy the following electrical rating. <table border="1" data-bbox="596 1760 1485 1832"> <thead> <tr> <th><Electrical Rating></th> </tr> </thead> <tbody> <tr> <td>220 to 240 VAC, 10 mA or more, 1 A or less</td> </tr> <tr> <td>24 VAC, 10 mA or more, 1 A or less (non-conductive load)</td> </tr> </tbody> </table> <p>When connecting a conductive load (e.g. relay coil) to the display relay load, insert a surge killer CR (for an AC power supply) or a diode for preventing back electromotive force (for a DC power supply) on the bypass circuit. The optional P.C. board should be connected to the header outdoor unit (U1).</p> <p>Note2: Specifications of COM terminal</p> <ol style="list-style-type: none"> For SW*, be sure to use non-voltage contacts for each terminal. COM terminals are DC12 V output with a basic insulation. Use a switch (relay or photocoupler) isolated from a controller (locally procured) for CO (Change-Over) contact or NO (normally-open) contact. DC12 V has a current-limiting resistor of 3.3 Ω. To use the relay, confirm a minimum applicable load for each relay and select the suitable relay to avoid a poor contact. 		Optional PCB			Outdoor unit interface PCB				Input		Display relay	SW105		Outdoor DN Code [00E]		SW1	SW2	(L1)	Bit1	Bit2	factory default [00E]=15	[00E]=0~10	Input demand OFF signal to release the demand	OFF	ON	OFF	OFF	OFF	100% (normal operation)	100% (normal operation)	Input demand ON signal to control the demand	ON	OFF	ON	OFF	OFF	0% (forced stop)	Approx. X% (50%~100%) (upper limit regulated)	Outdoor unit DN Code (O.DN) [00E]	X	0	100%	1	95%	2	90%	3	85%	4	80%	5	75%	6	70%	7	65%	8	60%	9	55%	10	50%	15 (factory default)	0% (forced stop)	<Electrical Rating>	220 to 240 VAC, 10 mA or more, 1 A or less
	Optional PCB			Outdoor unit interface PCB																																																																
	Input			Display relay	SW105		Outdoor DN Code [00E]																																																													
	SW1	SW2	(L1)	Bit1	Bit2	factory default [00E]=15	[00E]=0~10																																																													
Input demand OFF signal to release the demand	OFF	ON	OFF	OFF	OFF	100% (normal operation)	100% (normal operation)																																																													
Input demand ON signal to control the demand	ON	OFF	ON	OFF	OFF	0% (forced stop)	Approx. X% (50%~100%) (upper limit regulated)																																																													
Outdoor unit DN Code (O.DN) [00E]	X																																																																			
0	100%																																																																			
1	95%																																																																			
2	90%																																																																			
3	85%																																																																			
4	80%																																																																			
5	75%																																																																			
6	70%																																																																			
7	65%																																																																			
8	60%																																																																			
9	55%																																																																			
10	50%																																																																			
15 (factory default)	0% (forced stop)																																																																			
<Electrical Rating>																																																																				
220 to 240 VAC, 10 mA or more, 1 A or less																																																																				
24 VAC, 10 mA or more, 1 A or less (non-conductive load)																																																																				

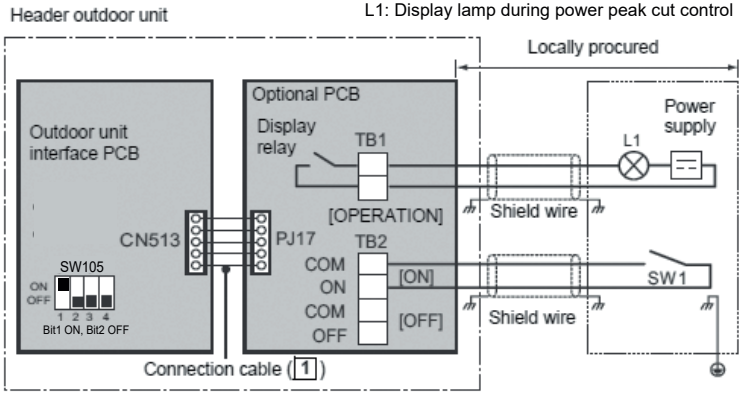
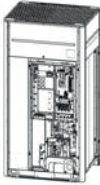
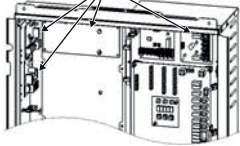
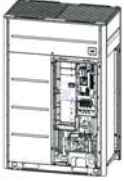
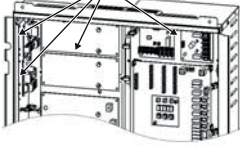
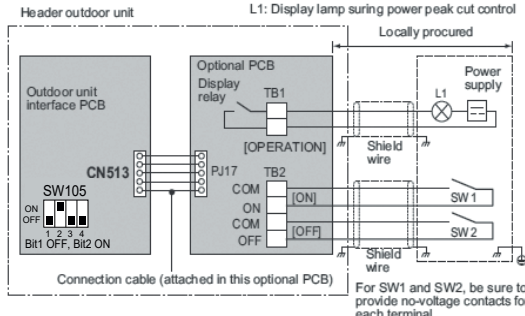
Model name	Appearance	Function																																		
TCB-PCDM4E	 <p>Size: 71 x 85 (mm)</p>	<p>For one input function (This function is possible only on the SMMS-u) Setting SW105 bit1 on I/F P.C.board of the header outdoor unit to ON allows ON/OFF power peak-cut control to be switched using [ON] terminal input (SW1) alone. (Wiring example)</p>  <p>Header outdoor unit L1: Display lamp during power peak cut control</p> <p>Locally procured</p> <p>Outdoor unit interface PCB Optional PCB</p> <p>Display relay TB1</p> <p>[OPERATION]</p> <p>Shield wire</p> <p>Power supply</p> <p>L1</p> <p>COM ON [ON]</p> <p>COM OFF [OFF]</p> <p>SW1</p> <p>Shield wire</p> <p>Connection cable (1)</p>																																		
	<p>Application</p>																																			
	 <p>MMY-MUP080 to 140</p> <p>Optional PCB</p>   <p>MMY-MUP160 to 200 MMY-MUP220 to 240</p> <p>Optional PCB</p>  <p>(max. number installed: 1pc)</p> <p>* Install the optional PCB in the outdoor header unit.</p>	<p>[2-stage switching] <SW105 bit1 ON, bit2 OFF> Power peak-cut control turns ON when SW 1 in the wiring example is ON (continuous make).</p> <table border="1" data-bbox="544 976 1469 1167"> <thead> <tr> <th rowspan="2"></th> <th colspan="2">Optional PCB</th> <th colspan="4">Outdoor unit interface PCB</th> </tr> <tr> <th>Input</th> <th>Display relay</th> <th colspan="2">SW105</th> <th colspan="2">Outdoor DN Code [00E]</th> </tr> </thead> <tbody> <tr> <td></td> <td>SW1</td> <td>(L1)</td> <td>Bit1</td> <td>Bit2</td> <td>factory default [00E]=15</td> <td>[00E]=0~10</td> </tr> <tr> <td>Input demand OFF signal to release the demand</td> <td>OFF</td> <td>OFF</td> <td>ON</td> <td>OFF</td> <td>100% (normal operation)</td> <td>100 % (normal operation)</td> </tr> <tr> <td>Input demand ON signal to control the demand</td> <td>ON</td> <td>ON</td> <td>ON</td> <td>OFF</td> <td>0% (forced stop)</td> <td>Approx. X% (50%~100%) (upper limit regulated)</td> </tr> </tbody> </table> <p>* The upper limit Z% can be regulated with the outdoor DN Code (O.DN) [00E].</p>		Optional PCB		Outdoor unit interface PCB				Input	Display relay	SW105		Outdoor DN Code [00E]			SW1	(L1)	Bit1	Bit2	factory default [00E]=15	[00E]=0~10	Input demand OFF signal to release the demand	OFF	OFF	ON	OFF	100% (normal operation)	100 % (normal operation)	Input demand ON signal to control the demand	ON	ON	ON	OFF	0% (forced stop)	Approx. X% (50%~100%) (upper limit regulated)
		Optional PCB		Outdoor unit interface PCB																																
Input		Display relay	SW105		Outdoor DN Code [00E]																															
	SW1	(L1)	Bit1	Bit2	factory default [00E]=15	[00E]=0~10																														
Input demand OFF signal to release the demand	OFF	OFF	ON	OFF	100% (normal operation)	100 % (normal operation)																														
Input demand ON signal to control the demand	ON	ON	ON	OFF	0% (forced stop)	Approx. X% (50%~100%) (upper limit regulated)																														
	<p>Enhanced Specifications (Wiring example)</p>  <p>Header outdoor unit L1: Display lamp during power peak cut control</p> <p>Locally procured</p> <p>Outdoor unit interface PCB Optional PCB</p> <p>Display relay TB1</p> <p>[OPERATION]</p> <p>Shield wire</p> <p>Power supply</p> <p>L1</p> <p>COM ON [ON]</p> <p>COM OFF [OFF]</p> <p>SW 1</p> <p>Shield wire</p> <p>SW 2</p> <p>Connection cable (attached in this optional PCB)</p> <p>For SW1 and SW2, be sure to provide no-voltage contacts for each terminal.</p> <p>Note1: Specifications of display relay contact</p> <ul style="list-style-type: none"> The terminal for display output ([Operation] terminal) must satisfy the following electrical rating. <table border="1" data-bbox="576 1659 1461 1727"> <thead> <tr> <th><Electrical Rating></th> </tr> </thead> <tbody> <tr> <td>220 to 240 VAC, 10 mA or more, 1 A or less</td> </tr> <tr> <td>24 VAC, 10 mA or more, 1 A or less (non-conductive load)</td> </tr> </tbody> </table> <p>When connecting a conductive load (e.g. relay coil) to the display relay load, insert a surge killer CR (for an AC power supply) or a diode for preventing back electromotive force (for a DC power supply) on the bypass circuit. The optional P.C. board should be connected to the header outdoor unit (U1).</p> <p>Note2: Specifications of COM terminal</p> <ol style="list-style-type: none"> For SW*, be sure to use non-voltage contacts for each terminal. COM terminals are DC12 V output with a basic insulation. Use a switch (relay or photocoupler) isolated from a controller (locally procured) for CO (Change-Over) contact or NO (normally-open) contact. DC12 V has a current-limiting resistor of 3.3 Ω. To use the relay, confirm a minimum applicable load for each relay and select the suitable relay to avoid a poor contact. 	<Electrical Rating>	220 to 240 VAC, 10 mA or more, 1 A or less	24 VAC, 10 mA or more, 1 A or less (non-conductive load)																																
<Electrical Rating>																																				
220 to 240 VAC, 10 mA or more, 1 A or less																																				
24 VAC, 10 mA or more, 1 A or less (non-conductive load)																																				

Model name	Appearance	Function																																																																																																																																					
TCB-PCDM4E		<p>[4-stage switching] <SW105 Bit1 ON, Bit2 ON></p> <table border="1" data-bbox="549 349 1469 573"> <thead> <tr> <th rowspan="2"></th> <th colspan="3">Optional PCB</th> <th colspan="2">SW105</th> <th colspan="2">Outdoor unit interface PCB</th> </tr> <tr> <th>Input</th> <th>SW2</th> <th>Display relay (L1)</th> <th>Bit1</th> <th>Bit2</th> <th>factory default</th> <th>Outdoor DN Code [**]</th> </tr> </thead> <tbody> <tr> <td>Input demand OFF signal to release the demand</td> <td>OFF</td> <td>OFF</td> <td>OFF</td> <td rowspan="4" style="text-align: center;">OFF</td> <td rowspan="4" style="text-align: center;">ON</td> <td>[00E]=15, [00F]=8, [010]=4</td> <td>[00E]=X, [00F]=Y, [010]=Z</td> </tr> <tr> <td>Input demand ON signal to control the demand</td> <td>ON</td> <td>OFF</td> <td>ON</td> <td>100% (normal operation)</td> <td>100% (normal operation)</td> </tr> <tr> <td>Input demand ON signal to control the demand</td> <td>OFF</td> <td>ON</td> <td>ON</td> <td>Approx. 80% (upper limit regulated)</td> <td>Approx. Z% (50%~100%) (upper limit regulated)</td> </tr> <tr> <td>Input demand ON signal to control the demand</td> <td>ON</td> <td>ON</td> <td>ON</td> <td>Approx. 60% (upper limit regulated)</td> <td>Approx. Y% (50%~100%) (upper limit regulated)</td> </tr> <tr> <td></td> <td></td> <td></td> <td></td> <td></td> <td></td> <td>0% (forced stop)</td> <td>Approx. X% (50%~100%) (upper limit regulated)</td> </tr> </tbody> </table> <p style="text-align: center; font-size: small;">* The upper limit X%, Y%, Z% can be regulated with the outdoor DN Code (O.DN) [00E] [00F] [010].</p> <table border="1" data-bbox="549 613 735 891" style="display: inline-table; margin-right: 20px;"> <thead> <tr> <th>Outdoor DN Code (O.DN)</th> <th>X</th> </tr> </thead> <tbody> <tr><td>[00E]</td><td></td></tr> <tr><td>0</td><td>100%</td></tr> <tr><td>1</td><td>95%</td></tr> <tr><td>2</td><td>90%</td></tr> <tr><td>3</td><td>85%</td></tr> <tr><td>4</td><td>80%</td></tr> <tr><td>5</td><td>75%</td></tr> <tr><td>6</td><td>70%</td></tr> <tr><td>7</td><td>65%</td></tr> <tr><td>8</td><td>60%</td></tr> <tr><td>9</td><td>55%</td></tr> <tr><td>10</td><td>50%</td></tr> <tr><td>15 (factory default)</td><td>0% (forced stop)</td></tr> </tbody> </table> <table border="1" data-bbox="794 613 981 891" style="display: inline-table; margin-right: 20px;"> <thead> <tr> <th>Outdoor DN Code (O.DN)</th> <th>Y</th> </tr> </thead> <tbody> <tr><td>[00F]</td><td></td></tr> <tr><td>0</td><td>100%</td></tr> <tr><td>1</td><td>95%</td></tr> <tr><td>2</td><td>90%</td></tr> <tr><td>3</td><td>85%</td></tr> <tr><td>4</td><td>80%</td></tr> <tr><td>5</td><td>75%</td></tr> <tr><td>6</td><td>70%</td></tr> <tr><td>7</td><td>65%</td></tr> <tr><td>8 (factory default)</td><td>60%</td></tr> <tr><td>9</td><td>55%</td></tr> <tr><td>10</td><td>50%</td></tr> <tr><td>15</td><td>0% (forced stop)</td></tr> </tbody> </table> <table border="1" data-bbox="1040 613 1227 891" style="display: inline-table;"> <thead> <tr> <th>Outdoor DN Code (O.DN)</th> <th>Z</th> </tr> </thead> <tbody> <tr><td>[010]</td><td></td></tr> <tr><td>0</td><td>100%</td></tr> <tr><td>1</td><td>95%</td></tr> <tr><td>2</td><td>90%</td></tr> <tr><td>3</td><td>85%</td></tr> <tr><td>4 (factory default)</td><td>80%</td></tr> <tr><td>5</td><td>75%</td></tr> <tr><td>6</td><td>70%</td></tr> <tr><td>7</td><td>65%</td></tr> <tr><td>8</td><td>60%</td></tr> <tr><td>9</td><td>55%</td></tr> <tr><td>10</td><td>50%</td></tr> <tr><td>15</td><td>0% (forced stop)</td></tr> </tbody> </table>		Optional PCB			SW105		Outdoor unit interface PCB		Input	SW2	Display relay (L1)	Bit1	Bit2	factory default	Outdoor DN Code [**]	Input demand OFF signal to release the demand	OFF	OFF	OFF	OFF	ON	[00E]=15, [00F]=8, [010]=4	[00E]=X, [00F]=Y, [010]=Z	Input demand ON signal to control the demand	ON	OFF	ON	100% (normal operation)	100% (normal operation)	Input demand ON signal to control the demand	OFF	ON	ON	Approx. 80% (upper limit regulated)	Approx. Z% (50%~100%) (upper limit regulated)	Input demand ON signal to control the demand	ON	ON	ON	Approx. 60% (upper limit regulated)	Approx. Y% (50%~100%) (upper limit regulated)							0% (forced stop)	Approx. X% (50%~100%) (upper limit regulated)	Outdoor DN Code (O.DN)	X	[00E]		0	100%	1	95%	2	90%	3	85%	4	80%	5	75%	6	70%	7	65%	8	60%	9	55%	10	50%	15 (factory default)	0% (forced stop)	Outdoor DN Code (O.DN)	Y	[00F]		0	100%	1	95%	2	90%	3	85%	4	80%	5	75%	6	70%	7	65%	8 (factory default)	60%	9	55%	10	50%	15	0% (forced stop)	Outdoor DN Code (O.DN)	Z	[010]		0	100%	1	95%	2	90%	3	85%	4 (factory default)	80%	5	75%	6	70%	7	65%	8	60%	9	55%	10	50%	15	0% (forced stop)
				Optional PCB			SW105		Outdoor unit interface PCB																																																																																																																														
			Input	SW2	Display relay (L1)	Bit1	Bit2	factory default	Outdoor DN Code [**]																																																																																																																														
		Input demand OFF signal to release the demand	OFF	OFF	OFF	OFF	ON	[00E]=15, [00F]=8, [010]=4	[00E]=X, [00F]=Y, [010]=Z																																																																																																																														
		Input demand ON signal to control the demand	ON	OFF	ON			100% (normal operation)	100% (normal operation)																																																																																																																														
		Input demand ON signal to control the demand	OFF	ON	ON			Approx. 80% (upper limit regulated)	Approx. Z% (50%~100%) (upper limit regulated)																																																																																																																														
		Input demand ON signal to control the demand	ON	ON	ON			Approx. 60% (upper limit regulated)	Approx. Y% (50%~100%) (upper limit regulated)																																																																																																																														
								0% (forced stop)	Approx. X% (50%~100%) (upper limit regulated)																																																																																																																														
		Outdoor DN Code (O.DN)	X																																																																																																																																				
		[00E]																																																																																																																																					
0	100%																																																																																																																																						
1	95%																																																																																																																																						
2	90%																																																																																																																																						
3	85%																																																																																																																																						
4	80%																																																																																																																																						
5	75%																																																																																																																																						
6	70%																																																																																																																																						
7	65%																																																																																																																																						
8	60%																																																																																																																																						
9	55%																																																																																																																																						
10	50%																																																																																																																																						
15 (factory default)	0% (forced stop)																																																																																																																																						
Outdoor DN Code (O.DN)	Y																																																																																																																																						
[00F]																																																																																																																																							
0	100%																																																																																																																																						
1	95%																																																																																																																																						
2	90%																																																																																																																																						
3	85%																																																																																																																																						
4	80%																																																																																																																																						
5	75%																																																																																																																																						
6	70%																																																																																																																																						
7	65%																																																																																																																																						
8 (factory default)	60%																																																																																																																																						
9	55%																																																																																																																																						
10	50%																																																																																																																																						
15	0% (forced stop)																																																																																																																																						
Outdoor DN Code (O.DN)	Z																																																																																																																																						
[010]																																																																																																																																							
0	100%																																																																																																																																						
1	95%																																																																																																																																						
2	90%																																																																																																																																						
3	85%																																																																																																																																						
4 (factory default)	80%																																																																																																																																						
5	75%																																																																																																																																						
6	70%																																																																																																																																						
7	65%																																																																																																																																						
8	60%																																																																																																																																						
9	55%																																																																																																																																						
10	50%																																																																																																																																						
15	0% (forced stop)																																																																																																																																						

Power peak-cut control by power consumption

Peak cut control by power consumption can be set with Outdoor DN CODE (O.DN) [009].

Peak cut control by power consumption adjusts the outdoor unit output so that the power consumption does not exceed the upper limit control value.

[1] Setting “Outdoor DN [009] = 1” changes the control method to peak cut control by power consumption. (Setting “Outdoor DN [009] = 0” returns the control method to normal peak cut control.)

[2] Check Outdoor DN [00A] to [00D] to make sure that upper power limit reference values for cooling and heating are registered.

Outdoor unit DN Code (O.DN) [00C], [00D] Cooling upper limit power standard setting

Ex. The upper limit of cooling power consumption setting = 19.35kw

Outdoor DN Code (O.DN)	[00C]	[00D]
Value	19	35

Outdoor unit DN Code (O.DN) [00A], [00B] Heating upper limit power standard setting

Ex. The upper limit of heating power consumption setting = 14.00kw

Outdoor DN Code (O.DN)	[00A]	[00B]
Value	14	00

[3] When an ON signal is input from the optional PCB, peak cut control by power consumption is enabled. The way to input the ON signal is the same as with normal peak cut control. Refer to the sections on “Standard Specifications”, “For one input function” and “Enhanced Specifications”.

Based on the upper power limit reference values registered in [2], the outdoor unit capacity is adjusted so that the upper limit control value set with Outdoor DN Code (O.DN) [00E], [00F], and [010] is not exceeded.

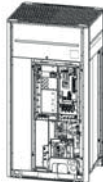
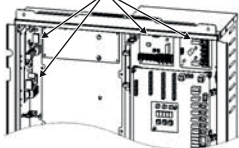
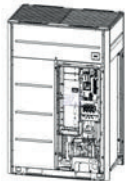
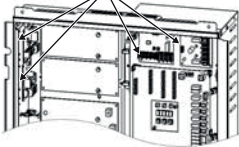
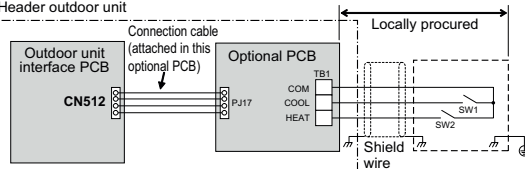
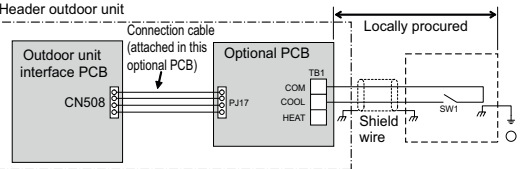

NOTE:

- * To protect the cycle, peak cut control by power consumption may not be carried out. (During defrosting operation, oil recovery operation, coolant recovery operation, etc.)
- * The value of power consumption is computed by estimation, so an error of about ±5% from the actual value occurs.
If you want to perform accurate peak cut control by power consumption and demand control, use a power meter and demand controller.
- * If the desired effect cannot be obtained, e.g. if the power consumption does not go down as much as expected, make adjustment by changing the set values of power upper limit reference and coefficient α (upper limit control (%)).

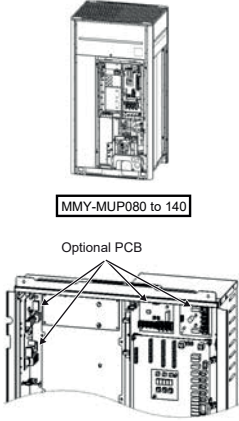
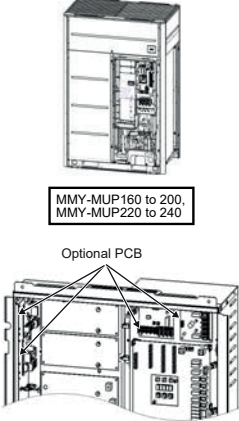
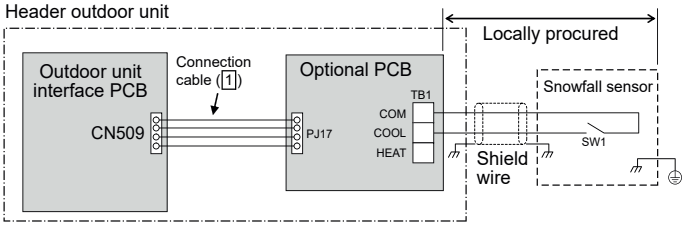
Model name	Appearance	Function																			
TCB-PCMO4E	 <p>Size: 55.5 x 60 (mm)</p>	<p>[2] External master ON/OFF control</p> <ul style="list-style-type: none"> • Feature The outdoor unit starts or stop the system. • Function By connecting the cable (attached in this optional PCB) to the interface PC board on an outdoor unit, all indoor units connected to the outdoor unit enable to operate simultaneously. • Operation The outdoor unit connection is for the header unit (U1). 																			
	<p>Application</p>  <p>MMY-MUP080 to 140</p> <p>Optional PCB</p>   <p>MMY-MUP160 to 200, MMY-MUP220 to 240</p> <p>Optional PCB</p>  <p>(max. number installed: 1pc)</p> <p>* Install the optional PCB in the outdoor header unit.</p>	 <p>Header outdoor unit</p> <p>Outdoor unit interface PCB (CN512) connected to Optional PCB (PJ17). Terminals: COM, COOL, HEAT. Includes SW1 and SW2, and shield wire.</p> <p>SW1: Operation input switch SW2: Stop input switch</p> <table border="1" data-bbox="550 739 1364 996"> <thead> <tr> <th>Terminal</th> <th>Input signal</th> <th>Operation</th> </tr> </thead> <tbody> <tr> <td>[SW1] COOL</td> <td> <p>100ms</p> <p>Accept operation start</p> <p>SW1 OFF before transmit batch-stop signal</p> </td> <td>All indoor units operate together</td> </tr> <tr> <td>[SW2] HEAT</td> <td> <p>100ms</p> <p>Accept operation stop</p> <p>Batch-operation</p> <p>Batch-stop</p> </td> <td>All indoor units stop together</td> </tr> </tbody> </table> <p>The input signal is recognized during its falling phase. (After reaching the bottom of the falling edge, the signal must remain there for at least 100 ms.) The control turned ON first is valid, and the control turned ON later is not accepted when cooling (SW1) and Heating (SW2) input ON at one time.</p> <p>Note</p> <ol style="list-style-type: none"> (1) For SW*, be sure to use non-voltage contacts for each terminal. (2) COM terminals are DC12 V output with a basic insulation. Use a switch (relay or photocoupler) isolated from a controller (locally procured) for CO (Change-Over) contact or NO (normally-open) contact. DC12 V has a current-limiting resistor of 3.3 Ω. To use the relay, confirm a minimum applicable load for each relay and select the suitable relay to avoid a poor contact. <p>[3] Night time operation (sound reduction) control</p> <ul style="list-style-type: none"> • Purpose: Reducing noise from an outdoor unit • Feature Sound level can be reduced by restricting the compressor and fan speed • Function As the cable (attached in this optional PCB) is connected to the "Interface PCB" on an outdoor unit, both compressor speed and fan speed are restricted while the signal of the night operation control is input. It makes the noise reduction during the night time operation. • Operation The outdoor unit connection is for the header unit (U1).  <p>Header outdoor unit</p> <p>Outdoor unit interface PCB (CN508) connected to Optional PCB (PJ17). Terminals: COM, COOL, HEAT. Includes SW1 and shield wire.</p> <p>SW1: Night time signal switch</p> <table border="1" data-bbox="550 1724 1109 1825"> <thead> <tr> <th>Terminal</th> <th>Input signal</th> <th>Operation</th> </tr> </thead> <tbody> <tr> <td rowspan="2">COOL (SW1)</td> <td>ON</td> <td rowspan="2">All indoor units operate together</td> </tr> <tr> <td>OFF</td> </tr> <tr> <td rowspan="2">HEAT (SW1)</td> <td>ON</td> <td rowspan="2">All indoor units stop together</td> </tr> <tr> <td>OFF</td> </tr> </tbody> </table> <p>Each terminal should be connected to dry contact. The input signal is recognized during its rising/falling phase. (After reaching the top/bottom of the rising/falling edge, the signal must remain there for at least 100 ms.)</p> <p>Note</p> <ol style="list-style-type: none"> (1) For SW*, be sure to use non-voltage contacts for each terminal. (2) COM terminals are DC12 V output with a basic insulation. Use a switch (relay or photocoupler) isolated from a controller (locally procured) for CO (Change-Over) contact or NO (normally-open) contact. DC12 V has a current-limiting resistor of 3.3 Ω. To use the relay, confirm a minimum applicable load for each relay and select the suitable relay to avoid a poor contact. 	Terminal	Input signal	Operation	[SW1] COOL	<p>100ms</p> <p>Accept operation start</p> <p>SW1 OFF before transmit batch-stop signal</p>	All indoor units operate together	[SW2] HEAT	<p>100ms</p> <p>Accept operation stop</p> <p>Batch-operation</p> <p>Batch-stop</p>	All indoor units stop together	Terminal	Input signal	Operation	COOL (SW1)	ON	All indoor units operate together	OFF	HEAT (SW1)	ON	All indoor units stop together
Terminal	Input signal	Operation																			
[SW1] COOL	<p>100ms</p> <p>Accept operation start</p> <p>SW1 OFF before transmit batch-stop signal</p>	All indoor units operate together																			
[SW2] HEAT	<p>100ms</p> <p>Accept operation stop</p> <p>Batch-operation</p> <p>Batch-stop</p>	All indoor units stop together																			
Terminal	Input signal	Operation																			
COOL (SW1)	ON	All indoor units operate together																			
	OFF																				
HEAT (SW1)	ON	All indoor units stop together																			
	OFF																				

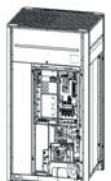
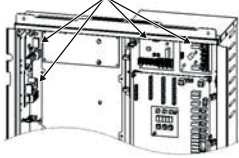
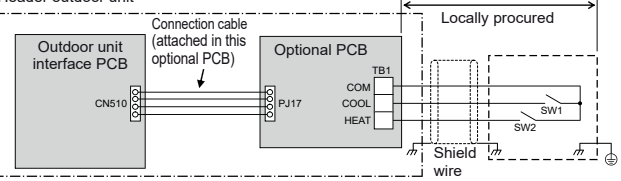
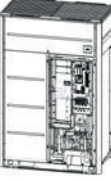
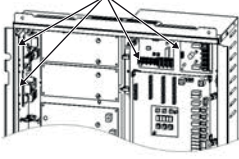
Model name	Appearance	Function																																										
TCB-PCMO4E	 <p>Size: 55.5 x 60 (mm)</p>	<p>Sound reduction and approximation capacity (reference)</p> <table border="1" data-bbox="545 349 1382 663"> <thead> <tr> <th rowspan="2">Outdoor unit</th> <th rowspan="2">Night operation sound reduction dB(A) (COOL/HEAT)</th> <th colspan="2">Capacity</th> </tr> <tr> <th>COOL</th> <th>HEAT</th> </tr> </thead> <tbody> <tr><td>0801 type</td><td>50 / 50</td><td>Approx. 85%</td><td>Approx. 80%</td></tr> <tr><td>1001 type</td><td>50 / 50</td><td>Approx. 70%</td><td>Approx. 65%</td></tr> <tr><td>1201 type</td><td>50 / 50</td><td>Approx. 60%</td><td>Approx. 55%</td></tr> <tr><td>1401 type</td><td>50 / 50</td><td>Approx. 70%</td><td>Approx. 65%</td></tr> <tr><td>1601 type</td><td>53 / 53</td><td>Approx. 70%</td><td>Approx. 70%</td></tr> <tr><td>1801 type</td><td>54 / 54</td><td>Approx. 65%</td><td>Approx. 65%</td></tr> <tr><td>2001 type</td><td>54 / 54</td><td>Approx. 60%</td><td>Approx. 60%</td></tr> <tr><td>2201 type</td><td>52 / 54</td><td>Approx. 55%</td><td>Approx. 55%</td></tr> <tr><td>2401 type</td><td>53 / 54</td><td>Approx. 55%</td><td>Approx. 55%</td></tr> </tbody> </table>	Outdoor unit	Night operation sound reduction dB(A) (COOL/HEAT)	Capacity		COOL	HEAT	0801 type	50 / 50	Approx. 85%	Approx. 80%	1001 type	50 / 50	Approx. 70%	Approx. 65%	1201 type	50 / 50	Approx. 60%	Approx. 55%	1401 type	50 / 50	Approx. 70%	Approx. 65%	1601 type	53 / 53	Approx. 70%	Approx. 70%	1801 type	54 / 54	Approx. 65%	Approx. 65%	2001 type	54 / 54	Approx. 60%	Approx. 60%	2201 type	52 / 54	Approx. 55%	Approx. 55%	2401 type	53 / 54	Approx. 55%	Approx. 55%
	Outdoor unit	Night operation sound reduction dB(A) (COOL/HEAT)			Capacity																																							
COOL			HEAT																																									
0801 type	50 / 50	Approx. 85%	Approx. 80%																																									
1001 type	50 / 50	Approx. 70%	Approx. 65%																																									
1201 type	50 / 50	Approx. 60%	Approx. 55%																																									
1401 type	50 / 50	Approx. 70%	Approx. 65%																																									
1601 type	53 / 53	Approx. 70%	Approx. 70%																																									
1801 type	54 / 54	Approx. 65%	Approx. 65%																																									
2001 type	54 / 54	Approx. 60%	Approx. 60%																																									
2201 type	52 / 54	Approx. 55%	Approx. 55%																																									
2401 type	53 / 54	Approx. 55%	Approx. 55%																																									
<p>Application</p>  <p>MMY-MUP080 to 140</p> <p>Optional PCB</p>  <p>MMY-MUP160 to 200, MMY-MUP220 to 240</p> <p>Optional PCB</p> <p>(max. number installed: 1pc)</p> <p>* Install the optional PCB in the outdoor header unit.</p>	<p>Condition Cooling: (Indoor 27 deg DB, 19 deg WB) (Outdoor temperature 25 deg DB) Heating: (Indoor 20 deg DB) (Outdoor temperature 7 deg DB, 6 deg WB)</p> <p>[4] Snowfall fan control</p> <ul style="list-style-type: none"> • Purpose: Rotating the fan to prevent snow accumulation • Feature <p>Outdoor fan is operated from the snowfall signal received from the outside.</p> <p>▼ Functions The outdoor unit fan operates at snowfall by connecting to the outdoor unit interface PCB.</p> <p>▼ Operation</p>  <p>SW1: Snowfall selection switch (snowfall sensor)</p> <table border="1" data-bbox="545 1326 1436 1489"> <thead> <tr> <th>Terminal</th> <th>Input signal</th> <th>Operation</th> </tr> </thead> <tbody> <tr> <td rowspan="2">Cooling (SW1)</td> <td>ON OFF</td> <td>Snowfall fan control (Fan in outdoor unit operates.)</td> </tr> <tr> <td>ON OFF</td> <td>Normal operation</td> </tr> </tbody> </table> <p>Be sure to provide no-voltage continuous contacts for each terminal.</p> <p>Note</p> <p>(1) For SW*, be sure to use non-voltage contacts for each terminal. (2) COM terminals are DC12 V output with a basic insulation. Use a switch (relay or photocoupler) isolated from a controller (locally procured) for CO (Change-Over) contact or NO (normally-open) contact. DC12 V has a current-limiting resistor of 3.3 Ω. To use the relay, confirm a minimum applicable load for each relay and select the suitable relay to avoid a poor contact.</p>	Terminal	Input signal	Operation	Cooling (SW1)	ON OFF	Snowfall fan control (Fan in outdoor unit operates.)	ON OFF	Normal operation																																			
Terminal	Input signal	Operation																																										
Cooling (SW1)	ON OFF	Snowfall fan control (Fan in outdoor unit operates.)																																										
	ON OFF	Normal operation																																										

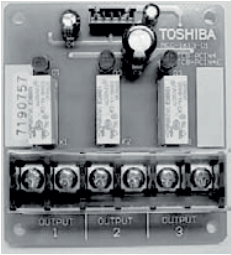
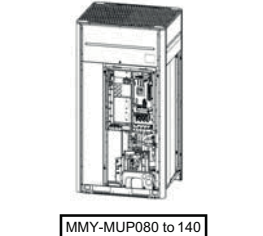
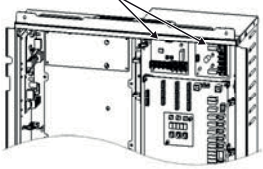
Model name	Appearance	Function																																					
TCB-PCMO4E	 <p>Size: 55.5 x 60 (mm)</p>	<p>[5] Operation mode selection control</p> <ul style="list-style-type: none"> • Purpose: Limiting operation modes to cooling and heating only • Feature <p>This control can restrict the selectable operation mode.</p> <p>▼ Functions</p> <p>The heating/cooling mode of the system can be selected by connecting to the interface PCB of outdoor units.</p> <p>▼ Operation</p> <p>The outdoor unit connection is for the header unit (U1).</p>																																					
	<p>Application</p>  <p>MMY-MUP080 to 140</p> <p>Optional PCB</p> 	 <p>Header outdoor unit</p> <p>SW1: Cooling mode specified input switch SW2: Heating mode specified input switch</p> <table border="1" data-bbox="550 862 1157 974"> <thead> <tr> <th colspan="2">Input Signal</th> <th rowspan="2">Operation: Selected operation mode</th> </tr> <tr> <th>Cool (SW1)</th> <th>Heat(SW2)</th> </tr> </thead> <tbody> <tr> <td>OFF</td> <td>OFF</td> <td>Normal operation</td> </tr> <tr> <td>ON</td> <td>OFF</td> <td>Cooling operation only</td> </tr> <tr> <td>OFF</td> <td>ON</td> <td>Heating operation only</td> </tr> </tbody> </table> <p>Each terminal should be connected to dry contact.</p> <p>About Switching of Processing of Indoor Unit Operation State</p> <p>Processing of the operation state can be switched for indoor units in a mode other than the selected operation mode by setting the Outdoor DN code [008] of the header outdoor unit interface PCB.</p> <table border="1" data-bbox="550 1131 1372 1400"> <thead> <tr> <th rowspan="2">Outdoor DN Code (O.DN) [008]</th> <th colspan="3">Details of Processing</th> </tr> <tr> <th>P.C. board selection mode</th> <th>Input Signal COOL (SW1) HEAT (SW2)</th> <th>Remote control</th> <th>Operation State</th> </tr> </thead> <tbody> <tr> <td rowspan="4">O.DN [008] = 0 (factory default)</td> <td>Normal</td> <td>OFF OFF</td> <td>* or Δ * *</td> <td>Follow the remote controller.</td> </tr> <tr> <td>Cooling operation only allowed</td> <td>ON OFF</td> <td>* or Δ * *</td> <td>Follow the remote controller (Normal cooling operation). Thermostat OFF (Air blow operation at super-slow blow rate)</td> </tr> <tr> <td rowspan="2">Heating operation only allowed</td> <td rowspan="2">OFF ON</td> <td>* or Δ</td> <td>Thermostat OFF (Air blow operation at blow rate set on remote control)</td> </tr> <tr> <td>* *</td> <td>Follow the remote controller (Normal heating operation). Follow the remote controller (Normal air blow operation).</td> </tr> </tbody> </table>	Input Signal		Operation: Selected operation mode	Cool (SW1)	Heat(SW2)	OFF	OFF	Normal operation	ON	OFF	Cooling operation only	OFF	ON	Heating operation only	Outdoor DN Code (O.DN) [008]	Details of Processing			P.C. board selection mode	Input Signal COOL (SW1) HEAT (SW2)	Remote control	Operation State	O.DN [008] = 0 (factory default)	Normal	OFF OFF	* or Δ * *	Follow the remote controller.	Cooling operation only allowed	ON OFF	* or Δ * *	Follow the remote controller (Normal cooling operation). Thermostat OFF (Air blow operation at super-slow blow rate)	Heating operation only allowed	OFF ON	* or Δ	Thermostat OFF (Air blow operation at blow rate set on remote control)	* *	Follow the remote controller (Normal heating operation). Follow the remote controller (Normal air blow operation).
	Input Signal		Operation: Selected operation mode																																				
Cool (SW1)	Heat(SW2)																																						
OFF	OFF	Normal operation																																					
ON	OFF	Cooling operation only																																					
OFF	ON	Heating operation only																																					
Outdoor DN Code (O.DN) [008]	Details of Processing																																						
	P.C. board selection mode	Input Signal COOL (SW1) HEAT (SW2)	Remote control	Operation State																																			
O.DN [008] = 0 (factory default)	Normal	OFF OFF	* or Δ * *	Follow the remote controller.																																			
	Cooling operation only allowed	ON OFF	* or Δ * *	Follow the remote controller (Normal cooling operation). Thermostat OFF (Air blow operation at super-slow blow rate)																																			
	Heating operation only allowed	OFF ON	* or Δ	Thermostat OFF (Air blow operation at blow rate set on remote control)																																			
			* *	Follow the remote controller (Normal heating operation). Follow the remote controller (Normal air blow operation).																																			
 <p>MMY-MUP160 to 200, MMY-MUP220 to 240</p> <p>Optional PCB</p>  <p>(max. number installed: 1pc)</p> <p>* Install the optional PCB in the outdoor header unit.</p>	<table border="1" data-bbox="550 1411 1372 1680"> <thead> <tr> <th rowspan="2">O.DN [008]</th> <th rowspan="2">P.C. board selection mode</th> <th colspan="2">Input Signal</th> <th rowspan="2">Remote control</th> </tr> <tr> <th>COOL (SW1)</th> <th>HEAT (SW2)</th> </tr> </thead> <tbody> <tr> <td rowspan="3">O.DN [008] = 1</td> <td>Normal</td> <td>OFF</td> <td>OFF</td> <td>* Δ * or * can be selected.</td> </tr> <tr> <td>COOL</td> <td>ON</td> <td>OFF</td> <td>• Only * Δ or * can be selected. • Indoor units in Heat mode are forcibly switched to the Cool mode.</td> </tr> <tr> <td>HEAT</td> <td>OFF</td> <td>ON</td> <td>• Only * or * can be selected. • Indoor units in Cool or Dry mode are forcibly switched to the Heat mode.</td> </tr> </tbody> </table> <p>When using the remote control, (mode selector control) indicator is displayed.</p> <p>The jumper lead is not switched.</p> <p>Indoor units in a mode other than the selected operation mode are forcibly switched to the selected operation mode.</p> <p>Note</p> <p>(1) For SW*, be sure to use non-voltage contacts for each terminal.</p> <p>(2) COM terminals are DC12 V output with a basic insulation. Use a switch (relay or photocoupler) isolated from a controller (locally procured) for CO (Change-Over) contact or NO (normally-open) contact. DC12 V has a current-limiting resistor of 3.3 Ω. To use the relay, confirm a minimum applicable load for each relay and select the suitable relay to avoid a poor contact.</p>	O.DN [008]	P.C. board selection mode	Input Signal		Remote control	COOL (SW1)	HEAT (SW2)	O.DN [008] = 1	Normal	OFF	OFF	* Δ * or * can be selected.	COOL	ON	OFF	• Only * Δ or * can be selected. • Indoor units in Heat mode are forcibly switched to the Cool mode.	HEAT	OFF	ON	• Only * or * can be selected. • Indoor units in Cool or Dry mode are forcibly switched to the Heat mode.																		
O.DN [008]	P.C. board selection mode			Input Signal			Remote control																																
		COOL (SW1)	HEAT (SW2)																																				
O.DN [008] = 1	Normal	OFF	OFF	* Δ * or * can be selected.																																			
	COOL	ON	OFF	• Only * Δ or * can be selected. • Indoor units in Heat mode are forcibly switched to the Cool mode.																																			
	HEAT	OFF	ON	• Only * or * can be selected. • Indoor units in Cool or Dry mode are forcibly switched to the Heat mode.																																			

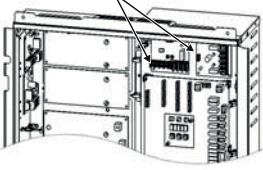
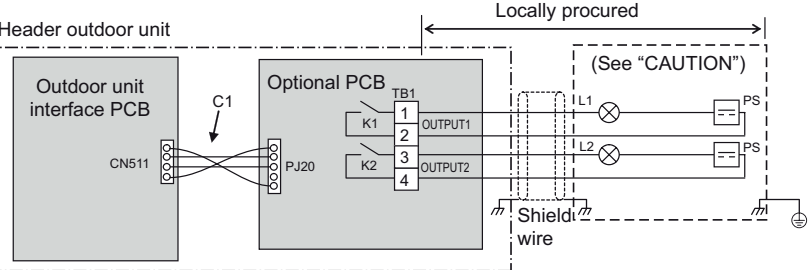
Model name	Appearance	Function																									
TCB-PCIN4E	 <p>Size: 73 x 79 (mm)</p>	<p>[6] Error / Operation Output</p> <ul style="list-style-type: none"> • Feature Operation and error monitoring is possible. <p>▼ Function The operation error output PCB can indicate operation and error states by connecting to the interface PCB of outdoor units.</p> <p>▼ Operation Operation output: The operation indicator is on while any indoor unit in the system is operating. Error output: The error indicator is on when an error is occurred on even one of the indoor or outdoor units in the system.</p>																									
	<p style="text-align: center;">Application</p>  <p style="text-align: center;">MMY-MUP080 to 140</p> <p style="text-align: center;">Optional PCB</p>   <p style="text-align: center;">MMY-MUP160 to 200, MMY-MUP220 to 240</p> <p style="text-align: center;">Optional PCB</p>  <p>(max. number installed: 1pc)</p> <p>* Install the optional PCB in the outdoor header unit.</p>	<p>Wiring example</p>  <table border="1" data-bbox="550 996 1428 1265"> <tr> <td>C1</td> <td>Attached connection cable 1 (4 wires)</td> </tr> <tr> <td>CN511</td> <td>Connector on interface side (green)</td> </tr> <tr> <td>K1, K2</td> <td>Relays</td> </tr> <tr> <td>L1</td> <td>Error indication Lamp</td> </tr> <tr> <td>L2</td> <td>Operation indication Lamp</td> </tr> <tr> <td>OUTPUT1</td> <td>Error output</td> </tr> <tr> <td>OUTPUT2</td> <td>Operation output</td> </tr> <tr> <td>PJ20</td> <td>Connector on optional PCB side</td> </tr> <tr> <td>PS</td> <td>Power supply unit</td> </tr> <tr> <td>TB1</td> <td>Terminal block</td> </tr> </table> <p>* [OUTPUT3] is normally output when power is turned out.</p> <p>Note1: Output Relay (K1, K2) Contact Specifications</p> <ul style="list-style-type: none"> • Output terminals (OUTPUT1, 2) must satisfy the following electrical rating. • When connecting a conductive load (e.g. relay coil) to loads K1 and K2, insert a surge killer CR (for an AC power supply) or a diode for preventing back electromotive force (for a DC power supply) on the bypass circuit. <table border="1" data-bbox="582 1422 1460 1500"> <tr> <td colspan="2" style="text-align: center;"><Electrical Rating></td> </tr> <tr> <td>220-240 VAC, 10 mA or more, 1A or less</td> <td></td> </tr> <tr> <td>24 VAC, 10 mA or more, 1 A or less (non-conductive load)</td> <td></td> </tr> </table>	C1	Attached connection cable 1 (4 wires)	CN511	Connector on interface side (green)	K1, K2	Relays	L1	Error indication Lamp	L2	Operation indication Lamp	OUTPUT1	Error output	OUTPUT2	Operation output	PJ20	Connector on optional PCB side	PS	Power supply unit	TB1	Terminal block	<Electrical Rating>		220-240 VAC, 10 mA or more, 1A or less		24 VAC, 10 mA or more, 1 A or less (non-conductive load)
C1	Attached connection cable 1 (4 wires)																										
CN511	Connector on interface side (green)																										
K1, K2	Relays																										
L1	Error indication Lamp																										
L2	Operation indication Lamp																										
OUTPUT1	Error output																										
OUTPUT2	Operation output																										
PJ20	Connector on optional PCB side																										
PS	Power supply unit																										
TB1	Terminal block																										
<Electrical Rating>																											
220-240 VAC, 10 mA or more, 1A or less																											
24 VAC, 10 mA or more, 1 A or less (non-conductive load)																											

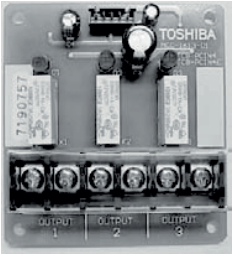
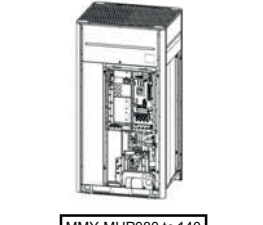
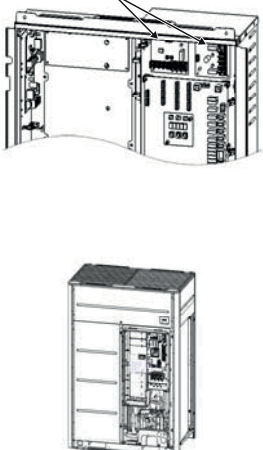
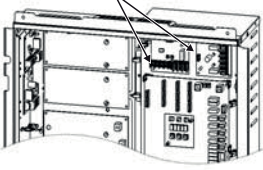
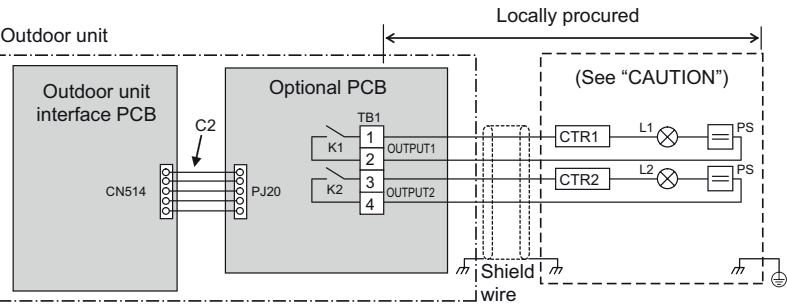
Model name	Appearance	Function																											
TCB-PCIN4E	 <p>Size: 73 x 79 (mm)</p>	<p>[7] Compressor Operation Output</p> <ul style="list-style-type: none"> • Feature Outputs the operation status of the compressors in each outdoor unit. <p>▼ Function This function can be applied, for example, to the elapsed operation time count of each compressor mounted on an outdoor unit since the compressor in operation signal can be output externally.</p> <p>▼ Operation During compressor operation, the relay of the output terminal corresponding to that compressor turns ON (closes) and turns OFF (opens) when compressor operation stops. As shown in the figure, the output terminals are "OUTPUT1" and "OUTPUT2" from the left compressor facing the front of the outdoor unit.</p>																											
	<p>Application</p>  <p>MMY-MUP080 to 140</p>  <p>Optional PCB</p> <p>MMY-MUP160 to 200, MMY-MUP220 to 240</p>  <p>Optional PCB</p> <p>(max. number installed: 1pc)</p> <p>* Install the optional PCB in the outdoor header unit.</p>	<p>Wiring example</p>  <table border="1" data-bbox="550 1153 1428 1444"> <tr> <td>C2</td> <td>Connector cable 2 (2)</td> </tr> <tr> <td>CN514</td> <td>Connector on interface side (green)</td> </tr> <tr> <td>CTR1</td> <td>Elapsed operation counter 1</td> </tr> <tr> <td>CTR2</td> <td>Elapsed operation counter 2</td> </tr> <tr> <td>K1, K2</td> <td>Relays</td> </tr> <tr> <td>L1, L2</td> <td>Operation indication LEDs</td> </tr> <tr> <td>OUTPUT1</td> <td>Compressor 1 operation output terminal</td> </tr> <tr> <td>OUTPUT2</td> <td>Compressor 2 operation output terminal</td> </tr> <tr> <td>PJ20</td> <td>Connector on optional PCB side</td> </tr> <tr> <td>PS</td> <td>Power supply unit</td> </tr> <tr> <td>TB1</td> <td>Terminal block</td> </tr> </table> <p>Note1: Output Relay (K1, K2) Contact Specifications</p> <ul style="list-style-type: none"> • Output terminals (OUTPUT1, 2) must satisfy the following electrical rating. • When connecting a conductive load (e.g. relay coil) to loads K1 and K2, insert a surge killer CR (for an AC power supply) or a diode for preventing back electromotive force (for a DC power supply) on the bypass circuit. <table border="1" data-bbox="582 1579 1460 1646"> <tr> <td colspan="2"><Electrical Rating></td> </tr> <tr> <td>220-240 VAC, 10 mA or more, 1A or less</td> <td></td> </tr> <tr> <td>24 VAC, 10 mA or more, 1 A or less (non-conductive load)</td> <td></td> </tr> </table>	C2	Connector cable 2 (2)	CN514	Connector on interface side (green)	CTR1	Elapsed operation counter 1	CTR2	Elapsed operation counter 2	K1, K2	Relays	L1, L2	Operation indication LEDs	OUTPUT1	Compressor 1 operation output terminal	OUTPUT2	Compressor 2 operation output terminal	PJ20	Connector on optional PCB side	PS	Power supply unit	TB1	Terminal block	<Electrical Rating>		220-240 VAC, 10 mA or more, 1A or less		24 VAC, 10 mA or more, 1 A or less (non-conductive load)
C2	Connector cable 2 (2)																												
CN514	Connector on interface side (green)																												
CTR1	Elapsed operation counter 1																												
CTR2	Elapsed operation counter 2																												
K1, K2	Relays																												
L1, L2	Operation indication LEDs																												
OUTPUT1	Compressor 1 operation output terminal																												
OUTPUT2	Compressor 2 operation output terminal																												
PJ20	Connector on optional PCB side																												
PS	Power supply unit																												
TB1	Terminal block																												
<Electrical Rating>																													
220-240 VAC, 10 mA or more, 1A or less																													
24 VAC, 10 mA or more, 1 A or less (non-conductive load)																													

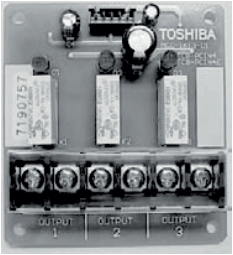
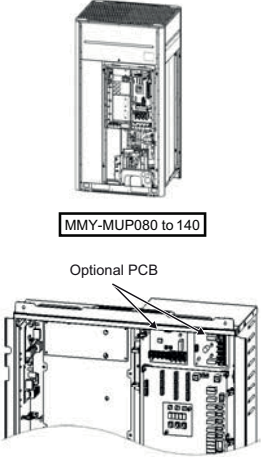
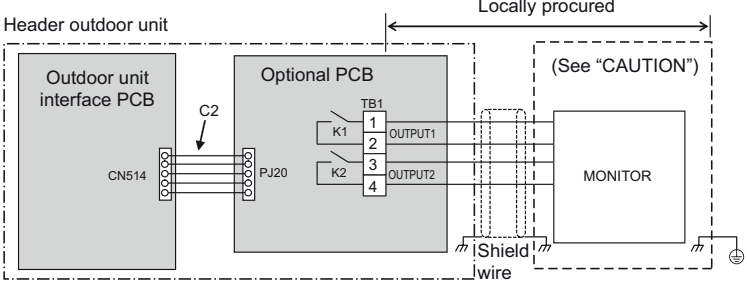
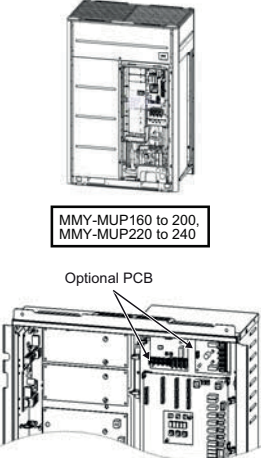
Model name	Appearance	Function																																								
TCB-PCIN4E	 <p>Size: 73 x 79 (mm)</p>	<p>[8] Operating Rate Output</p> <ul style="list-style-type: none"> • Feature Relay turn ON/OFF depending on the running rate of the system. ▼ Functions The operation state can be remotely checked since the system operating rate signal can be output externally. ▼ Operation As shown in the table, each of the output terminals turns ON (relay closes) and OFF (relay opens) according to the system operating rate. 																																								
	<p>Application</p>	<table border="1"> <thead> <tr> <th>Functions</th> <th>Outdoor DN Code (O.DN) [012]</th> <th>OUTPUT1</th> <th>OUTPUT2</th> <th>OUTPUT3</th> <th>Operating rate FA</th> </tr> </thead> <tbody> <tr> <td rowspan="8">System operating rate output</td> <td rowspan="8">O.DN [012] = 1</td> <td>OFF</td> <td>OFF</td> <td>OFF</td> <td>FA=0%</td> </tr> <tr> <td>ON</td> <td>OFF</td> <td>OFF</td> <td>0%<FA<20%</td> </tr> <tr> <td>OFF</td> <td>ON</td> <td>OFF</td> <td>20%≤FA<35%</td> </tr> <tr> <td>ON</td> <td>ON</td> <td>OFF</td> <td>35%≤FA<50%</td> </tr> <tr> <td>OFF</td> <td>OFF</td> <td>ON</td> <td>50%≤FA<65%</td> </tr> <tr> <td>ON</td> <td>OFF</td> <td>ON</td> <td>65%≤FA<80%</td> </tr> <tr> <td>OFF</td> <td>ON</td> <td>ON</td> <td>80%≤FA<95%</td> </tr> <tr> <td>ON</td> <td>ON</td> <td>ON</td> <td>95%≤FA</td> </tr> </tbody> </table> <p style="text-align: right;">OFF=relay open ON=relay closed</p>	Functions	Outdoor DN Code (O.DN) [012]	OUTPUT1	OUTPUT2	OUTPUT3	Operating rate FA	System operating rate output	O.DN [012] = 1	OFF	OFF	OFF	FA=0%	ON	OFF	OFF	0%<FA<20%	OFF	ON	OFF	20%≤FA<35%	ON	ON	OFF	35%≤FA<50%	OFF	OFF	ON	50%≤FA<65%	ON	OFF	ON	65%≤FA<80%	OFF	ON	ON	80%≤FA<95%	ON	ON	ON	95%≤FA
	Functions	Outdoor DN Code (O.DN) [012]	OUTPUT1	OUTPUT2	OUTPUT3	Operating rate FA																																				
	System operating rate output	O.DN [012] = 1	OFF	OFF	OFF	FA=0%																																				
ON			OFF	OFF	0%<FA<20%																																					
OFF			ON	OFF	20%≤FA<35%																																					
ON			ON	OFF	35%≤FA<50%																																					
OFF			OFF	ON	50%≤FA<65%																																					
ON			OFF	ON	65%≤FA<80%																																					
OFF			ON	ON	80%≤FA<95%																																					
ON			ON	ON	95%≤FA																																					
 <p>Optional PCB</p>	<p>Wiring example</p> 																																									
 <p>Optional PCB</p> <p>(max. number installed: 1pc)</p> <p>* Install the optional PCB in the outdoor header unit.</p>	<table border="1"> <tbody> <tr> <td>C2</td> <td>Connector cable 2 ([2])</td> </tr> <tr> <td>CN514</td> <td>Connector on interface side (green)</td> </tr> <tr> <td>K1, K2, K3</td> <td>Relays</td> </tr> <tr> <td>MONITOR</td> <td>Monitoring device</td> </tr> <tr> <td>OUTPUT1</td> <td>Output terminal for each function</td> </tr> <tr> <td>OUTPUT2</td> <td>Output terminal for each function</td> </tr> <tr> <td>OUTPUT3</td> <td>Output terminal for each function</td> </tr> <tr> <td>PJ20</td> <td>Connector on optional PCB side</td> </tr> <tr> <td>TB1</td> <td>Terminal block</td> </tr> </tbody> </table> <p>* Connect optional boards to the center outdoor unit.</p> <p>Note1: Output Relay (K1, K2) Contact Specifications</p> <ul style="list-style-type: none"> • Output terminals (OUTPUT1, 2) must satisfy the following electrical rating. • When connecting a conductive load (e.g. relay coil) to loads K1 and K2, insert a surge killer CR (for an AC power supply) or a diode for preventing back electromotive force (for a DC power supply) on the bypass circuit. <div style="border: 1px solid black; padding: 5px;"> <p><Electrical Rating> 220-240 VAC, 10 mA or more, 1A or less 24 VAC, 10 mA or more, 1 A or less (non-conductive load)</p> </div>	C2	Connector cable 2 ([2])	CN514	Connector on interface side (green)	K1, K2, K3	Relays	MONITOR	Monitoring device	OUTPUT1	Output terminal for each function	OUTPUT2	Output terminal for each function	OUTPUT3	Output terminal for each function	PJ20	Connector on optional PCB side	TB1	Terminal block																							
C2	Connector cable 2 ([2])																																									
CN514	Connector on interface side (green)																																									
K1, K2, K3	Relays																																									
MONITOR	Monitoring device																																									
OUTPUT1	Output terminal for each function																																									
OUTPUT2	Output terminal for each function																																									
OUTPUT3	Output terminal for each function																																									
PJ20	Connector on optional PCB side																																									
TB1	Terminal block																																									

Dimensions of P.C. board

Unit: in (mm)

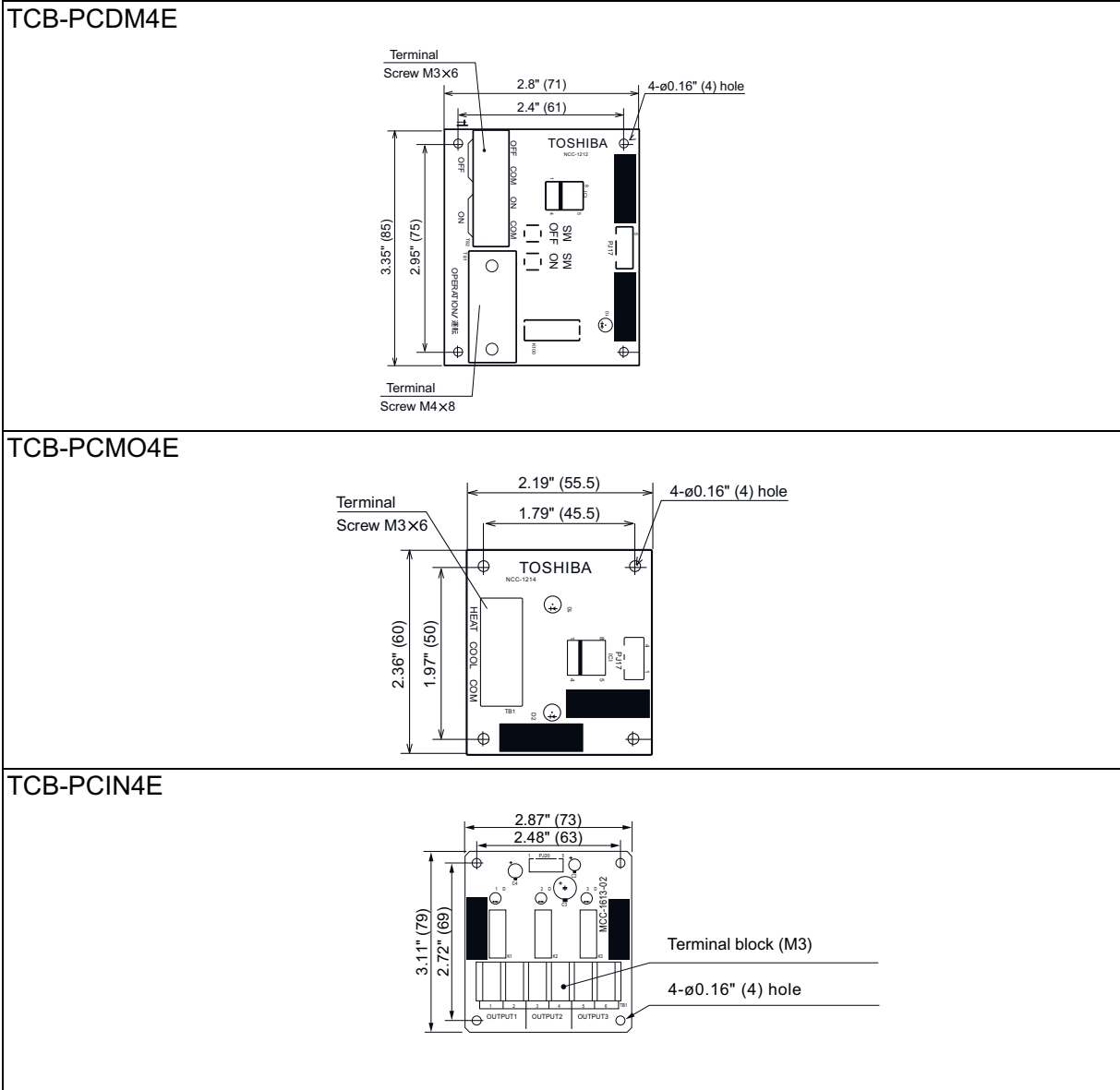

5-10. Part Load performance

MMY-MUP0801HT8P-E (8HP, 22.4 kW system)

Cooling		Compressor + Outdoor Fan Power consumption (kW)															
		100% Capacity		90% Capacity		80% Capacity		70% Capacity		60% Capacity		50% Capacity		40% Capacity		30% Capacity	
		TC	PI	TC	PI	TC	PI	TC	PI	TC	PI	TC	PI	TC	PI	TC	PI
Outdoor Unit Dry-Bulb (°C)	Outdoor Unit 100% Cooling Capacity (kW)	(kW)	(kW)	(kW)	(kW)	(kW)	(kW)	(kW)	(kW)	(kW)	(kW)	(kW)	(kW)	(kW)	(kW)	(kW)	
46 °C	17.5	17.5	6.36	15.8	5.21	14.0	4.18	12.3	3.26	10.5	2.46	8.77	1.76	7.02	1.18	5.26	0.72
43 °C	19.2	19.2	6.45	17.3	5.29	15.4	4.24	13.5	3.31	11.5	2.49	9.62	1.79	7.70	1.20	5.77	0.73
41 °C	20.5	20.5	6.60	18.4	5.41	16.4	4.33	14.3	3.38	12.3	2.54	10.2	1.82	8.20	1.22	6.15	0.74
39 °C	21.2	21.2	6.41	19.1	5.25	16.9	4.21	14.8	3.28	12.7	2.47	10.6	1.77	8.47	1.19	6.35	0.72
37 °C	21.8	21.8	6.21	19.6	5.09	17.4	4.08	15.3	3.18	13.1	2.39	10.9	1.72	8.72	1.15	6.54	0.70
35 °C	22.4	22.4	5.64	20.2	4.93	17.9	3.95	15.7	3.08	13.4	2.32	11.2	1.66	8.96	1.11	6.72	0.67
32 °C	22.4	22.4	5.56	20.2	4.56	17.9	3.66	15.7	2.85	13.4	2.15	11.2	1.54	8.96	1.03	6.72	0.63
31 °C	22.4	22.4	5.16	20.2	4.23	17.9	3.39	15.7	2.65	13.4	1.99	11.2	1.43	8.96	0.96	6.72	0.58
30 °C	22.4	22.4	4.97	20.2	4.08	17.9	3.27	15.7	2.55	13.4	1.92	11.2	1.38	8.96	0.93	6.72	0.56
29 °C	22.4	22.4	4.80	20.2	3.93	17.9	3.16	15.7	2.46	13.4	1.85	11.2	1.33	8.96	0.90	6.72	0.54
27 °C	22.4	22.4	4.47	20.2	3.67	17.9	2.94	15.7	2.30	13.4	1.73	11.2	1.24	8.96	0.84	6.72	0.51
25 °C	22.4	22.4	4.17	20.2	3.42	17.9	2.74	15.7	2.14	13.4	1.62	11.2	1.16	8.96	0.78	6.72	0.48
23 °C	22.4	22.4	3.98	20.2	3.27	17.9	2.62	15.7	2.05	13.4	1.54	11.2	1.11	8.96	0.75	6.72	0.45
21 °C	22.4	22.4	3.89	20.2	3.19	17.9	2.56	15.7	2.00	13.4	1.51	11.2	1.09	8.96	0.73	6.72	0.45
20 °C	22.4	22.4	3.85	20.2	3.16	17.9	2.54	15.7	1.98	13.4	1.50	11.2	1.08	8.96	0.72	6.72	0.44
19 °C	22.4	22.4	3.82	20.2	3.13	17.9	2.51	15.7	1.96	13.4	1.48	11.2	1.07	8.96	0.72	6.72	0.44
17 °C	22.4	22.4	3.75	20.2	3.08	17.9	2.47	15.7	1.93	13.4	1.46	11.2	1.05	8.96	0.71	6.72	0.43
15 °C	22.4	22.4	3.70	20.2	3.03	17.9	2.44	15.7	1.90	13.4	1.44	11.2	1.03	8.96	0.70	6.72	0.43

TC : Total Capacity PI : Power Input
Indoor air temperature conditions : 27.0°C dry-bulb / 19.0°C wet bulb

Heating		Compressor + Outdoor Fan Power consumption (kW)																
		100% Capacity		90% Capacity		80% Capacity		70% Capacity		60% Capacity		50% Capacity		40% Capacity		30% Capacity		
		TC	PI	TC	PI	TC	PI	TC	PI	TC	PI	TC	PI	TC	PI	TC	PI	
Outdoor Unit Dry-Bulb (°C)	Outdoor Unit Wet-Bulb (°C)	Outdoor Unit 100% Heating Capacity (kW)	(kW)	(kW)	(kW)	(kW)	(kW)	(kW)	(kW)	(kW)	(kW)	(kW)	(kW)	(kW)	(kW)	(kW)		
15.0	13.7	25.0	25.0	5.22	22.5	4.55	20.0	3.93	17.5	3.35	15.0	2.83	12.5	2.36	10.0	1.94	7.50	1.56
13.0	11.8	25.0	25.0	5.39	22.5	4.69	20.0	4.04	17.5	3.45	15.0	2.90	12.5	2.41	10.0	1.97	7.50	1.59
11.0	9.8	25.0	25.0	5.58	22.5	4.85	20.0	4.17	17.5	3.55	15.0	2.99	12.5	2.47	10.0	2.02	7.50	1.61
9.0	7.9	25.0	25.0	5.78	22.5	5.02	20.0	4.31	17.5	3.66	15.0	3.07	12.5	2.54	10.0	2.06	7.50	1.64
7.0	6.0	25.0	25.0	6.00	22.5	5.20	20.0	4.46	17.5	3.78	15.0	3.16	12.5	2.60	10.0	2.11	7.50	1.67
5.0	4.1	24.3	24.3	5.98	21.8	5.18	19.4	4.44	17.0	3.77	14.6	3.15	12.1	2.59	9.71	2.10	7.28	1.67
3.0	2.2	23.5	23.5	5.96	21.2	5.17	18.8	4.43	16.5	3.75	14.1	3.14	11.8	2.59	9.42	2.09	7.06	1.66
0.0	-0.7	22.4	22.4	5.94	20.2	5.14	17.9	4.41	15.7	3.74	13.5	3.13	11.2	2.57	8.97	2.08	6.73	1.65
-3.0	-3.7	21.3	21.3	5.91	19.1	5.12	17.0	4.39	14.9	3.72	12.8	3.11	10.6	2.56	8.51	2.07	6.38	1.64
-5.0	-5.6	20.5	20.5	5.89	18.5	5.10	16.4	4.37	14.4	3.71	12.3	3.10	10.3	2.55	8.22	2.07	6.16	1.64
-7.0	-7.6	19.8	19.8	5.87	17.8	5.09	15.8	4.36	13.8	3.70	11.9	3.09	9.88	2.55	7.91	2.06	5.93	1.63
-10	-10.5	18.7	18.7	5.84	16.8	5.06	14.9	4.34	13.1	3.68	11.2	3.08	9.33	2.53	7.46	2.05	5.60	1.63
-14.5	-15.0	16.9	16.9	5.80	15.2	5.02	13.5	4.31	11.8	3.65	10.2	3.05	8.46	2.51	6.77	2.03	5.08	1.61
-19.5	-20.0	15.0	15.0	5.75	13.5	4.98	12.0	4.27	10.5	3.62	9.00	3.03	7.50	2.49	6.00	2.02	4.50	1.60

TC : Total Capacity PI : Power Input
Indoor air temperature conditions : 20.0°C dry-bulb

MMY-MUP1001HT8P-E (10HP, 28.0kW system)

Cooling			Compressor + Outdoor Fan Power consumption (kW)															
			100% Capacity		90% Capacity		80% Capacity		70% Capacity		60% Capacity		50% Capacity		40% Capacity		30% Capacity	
			TC	PI	TC	PI	TC	PI	TC	PI	TC	PI	TC	PI	TC	PI	TC	PI
Outdoor Unit Dry-Bulb (°C)	Outdoor Unit 100% Cooling Capacity (kW)	(kW)	(kW)	(kW)	(kW)	(kW)	(kW)	(kW)	(kW)	(kW)	(kW)	(kW)	(kW)	(kW)	(kW)	(kW)		
46 °C	21.9	21.9	8.85	19.7	7.17	17.5	5.66	15.4	4.34	13.2	3.19	11.0	2.21	8.77	1.42	6.58	0.80	
43 °C	24.1	24.1	9.02	21.6	7.30	19.2	5.77	16.8	4.42	14.4	3.25	12.0	2.25	9.62	1.44	7.22	0.81	
41 °C	25.6	25.6	9.24	23.1	7.49	20.5	5.92	17.9	4.53	15.4	3.33	12.8	2.31	10.2	1.48	7.69	0.83	
39 °C	26.5	26.5	8.97	23.8	7.27	21.2	5.74	18.5	4.40	15.9	3.23	13.2	2.24	10.6	1.44	7.94	0.81	
37 °C	27.3	27.3	8.70	24.5	7.05	21.8	5.57	19.1	4.26	16.4	3.13	13.6	2.18	10.9	1.39	8.18	0.78	
35 °C	28.0	28.0	8.36	25.2	6.83	22.4	5.40	19.6	4.13	16.8	3.03	14.0	2.11	11.2	1.35	8.40	0.76	
32 °C	28.0	28.0	7.77	25.2	6.30	22.4	4.98	19.6	3.81	16.8	2.80	14.0	1.94	11.2	1.24	8.40	0.70	
31 °C	28.0	28.0	7.19	25.2	5.83	22.4	4.60	19.6	3.52	16.8	2.59	14.0	1.80	11.2	1.15	8.40	0.65	
30 °C	28.0	28.0	6.93	25.2	5.61	22.4	4.43	19.6	3.39	16.8	2.49	14.0	1.73	11.2	1.11	8.40	0.62	
29 °C	28.0	28.0	6.67	25.2	5.41	22.4	4.27	19.6	3.27	16.8	2.40	14.0	1.67	11.2	1.07	8.40	0.60	
27 °C	28.0	28.0	6.21	25.2	5.03	22.4	3.97	19.6	3.04	16.8	2.23	14.0	1.55	11.2	0.99	8.40	0.56	
25 °C	28.0	28.0	5.78	25.2	4.68	22.4	3.70	19.6	2.83	16.8	2.08	14.0	1.44	11.2	0.92	8.40	0.52	
23 °C	28.0	28.0	5.51	25.2	4.46	22.4	3.53	19.6	2.70	16.8	1.98	14.0	1.38	11.2	0.88	8.40	0.50	
21 °C	28.0	28.0	5.38	25.2	4.36	22.4	3.44	19.6	2.64	16.8	1.94	14.0	1.34	11.2	0.86	8.40	0.48	
20 °C	28.0	28.0	5.32	25.2	4.31	22.4	3.41	19.6	2.61	16.8	1.92	14.0	1.33	11.2	0.85	8.40	0.48	
19 °C	28.0	28.0	5.27	25.2	4.27	22.4	3.37	19.6	2.58	16.8	1.90	14.0	1.32	11.2	0.84	8.40	0.47	
17 °C	28.0	28.0	5.17	25.2	4.19	22.4	3.31	19.6	2.53	16.8	1.86	14.0	1.29	11.2	0.83	8.40	0.47	
15 °C	28.0	28.0	5.09	25.2	4.12	22.4	3.26	19.6	2.49	16.8	1.83	14.0	1.27	11.2	0.81	8.40	0.46	

TC : Total Capacity PI : Power Input
Indoor air temperature conditions : 27.0°C dry-bulb / 19.0°C wet bulb

Heating			Compressor + Outdoor Fan Power consumption (kW)															
			100% Capacity		90% Capacity		80% Capacity		70% Capacity		60% Capacity		50% Capacity		40% Capacity		30% Capacity	
			TC	PI	TC	PI	TC	PI	TC	PI	TC	PI	TC	PI	TC	PI	TC	PI
Outdoor Unit Dry-Bulb (°C)	Outdoor Unit Wet-Bulb (°C)	Outdoor Unit 100% Heating Capacity (kW)	(kW)	(kW)	(kW)	(kW)	(kW)	(kW)	(kW)	(kW)	(kW)	(kW)	(kW)	(kW)	(kW)	(kW)		
15.0	13.7	31.5	31.5	7.24	28.4	6.32	25.2	5.44	22.1	4.61	18.9	3.81	15.8	3.07	12.6	2.37	9.45	1.71
13.0	11.8	31.5	31.5	7.47	28.4	6.52	25.2	5.61	22.1	4.74	18.9	3.93	15.8	3.16	12.6	2.43	9.45	1.75
11.0	9.8	31.5	31.5	7.74	28.4	6.74	25.2	5.80	22.1	4.90	18.9	4.05	15.8	3.26	12.6	2.51	9.45	1.81
9.0	7.9	31.5	31.5	8.00	28.4	6.97	25.2	5.99	22.1	5.06	18.9	4.18	15.8	3.36	12.6	2.58	9.45	1.86
7.0	6.0	31.5	31.5	8.29	28.4	7.22	25.2	6.20	22.1	5.23	18.9	4.32	15.8	3.46	12.6	2.66	9.45	1.91
5.0	4.1	30.6	30.6	8.26	27.5	7.19	24.5	6.18	21.4	5.21	18.3	4.31	15.3	3.45	12.2	2.65	9.17	1.91
3.0	2.2	29.7	29.7	8.24	26.7	7.17	23.7	6.16	20.8	5.20	17.8	4.29	14.8	3.44	11.9	2.64	8.90	1.90
0.0	-0.7	28.3	28.3	8.20	25.4	7.14	22.6	6.13	19.8	5.17	17.0	4.27	14.1	3.43	11.3	2.63	8.48	1.89
-3.0	-3.7	26.8	26.8	8.16	24.1	7.10	21.4	6.10	18.8	5.15	16.1	4.25	13.4	3.41	10.7	2.62	8.04	1.88
-5.0	-5.6	25.9	25.9	8.14	23.3	7.08	20.7	6.08	18.1	5.13	15.5	4.24	12.9	3.40	10.4	2.61	7.76	1.88
-7.0	-7.6	24.9	24.9	8.11	22.4	7.06	19.9	6.06	17.4	5.12	14.9	4.23	12.5	3.39	9.96	2.60	7.47	1.87
-10	-10.5	23.5	23.5	8.07	21.2	7.02	18.8	6.03	16.5	5.09	14.1	4.21	11.8	3.37	9.40	2.59	7.05	1.86
-14.5	-15.0	21.3	21.3	8.01	19.2	6.97	17.1	5.99	14.9	5.05	12.8	4.17	10.7	3.35	8.53	2.57	6.40	1.85
-19.5	-20.0	18.9	18.9	7.95	17.0	6.92	15.1	5.94	13.2	5.01	11.34	4.14	9.45	3.32	7.56	2.55	5.67	1.83

TC : Total Capacity PI : Power Input
Indoor air temperature conditions : 20.0°C dry-bulb

MMY-MUP1201HT8P-E (12HP, 33.5 kW system)

Cooling			Compressor + Outdoor Fan Power consumption (kW)														
Outdoor Unit Dry-Bulb (°C)	Outdoor Unit 100% Cooling Capacity (kW)	100% Capacity		90% Capacity		80% Capacity		70% Capacity		60% Capacity		50% Capacity		40% Capacity		30% Capacity	
		TC	PI	TC	PI	TC	PI	TC	PI	TC	PI	TC	PI	TC	PI	TC	PI
		(kW)	(kW)	(kW)	(kW)	(kW)	(kW)	(kW)	(kW)	(kW)	(kW)	(kW)	(kW)	(kW)	(kW)	(kW)	(kW)
46 °C	26.2	26.2	10.61	23.6	8.64	21.0	6.87	18.4	5.31	15.7	3.94	13.1	2.78	10.5	1.82	7.87	1.06
43 °C	28.8	28.8	10.79	25.9	8.79	23.0	6.99	20.1	5.40	17.3	4.01	14.4	2.83	11.5	1.85	8.63	1.08
41 °C	30.7	30.7	11.05	27.6	9.00	24.5	7.15	21.5	5.52	18.4	4.10	15.3	2.89	12.3	1.89	9.20	1.10
39 °C	31.7	31.7	10.73	28.5	8.73	25.3	6.95	22.2	5.36	19.0	3.98	15.8	2.81	12.7	1.84	9.50	1.07
37 °C	32.6	32.6	10.40	29.4	8.47	26.1	6.74	22.8	5.20	19.6	3.86	16.3	2.72	13.0	1.78	9.79	1.04
35 °C	33.5	33.5	10.34	30.2	8.21	26.8	6.53	23.5	5.04	20.1	3.74	16.8	2.64	13.4	1.73	10.1	1.01
32 °C	33.5	33.5	9.30	30.2	7.58	26.8	6.03	23.5	4.65	20.1	3.46	16.8	2.44	13.4	1.60	10.1	0.93
31 °C	33.5	33.5	8.62	30.2	7.02	26.8	5.58	23.5	4.31	20.1	3.20	16.8	2.26	13.4	1.48	10.1	0.86
30 °C	33.5	33.5	8.30	30.2	6.76	26.8	5.38	23.5	4.15	20.1	3.09	16.8	2.18	13.4	1.43	10.1	0.83
29 °C	33.5	33.5	8.00	30.2	6.52	26.8	5.19	23.5	4.00	20.1	2.98	16.8	2.10	13.4	1.38	10.1	0.80
27 °C	33.5	33.5	7.45	30.2	6.07	26.8	4.83	23.5	3.73	20.1	2.77	16.8	1.96	13.4	1.28	10.1	0.75
25 °C	33.5	33.5	6.94	30.2	5.65	26.8	4.50	23.5	3.48	20.1	2.58	16.8	1.82	13.4	1.20	10.1	0.70
23 °C	33.5	33.5	6.62	30.2	5.39	26.8	4.29	23.5	3.32	20.1	2.47	16.8	1.74	13.4	1.14	10.1	0.67
21 °C	33.5	33.5	6.47	30.2	5.27	26.8	4.19	23.5	3.24	20.1	2.41	16.8	1.70	13.4	1.12	10.1	0.65
20 °C	33.5	33.5	6.40	30.2	5.22	26.8	4.15	23.5	3.21	20.1	2.39	16.8	1.68	13.4	1.11	10.1	0.65
19 °C	33.5	33.5	6.34	30.2	5.16	26.8	4.11	23.5	3.18	20.1	2.36	16.8	1.67	13.4	1.09	10.1	0.64
17 °C	33.5	33.5	6.23	30.2	5.07	26.8	4.04	23.5	3.12	20.1	2.32	16.8	1.64	13.4	1.08	10.1	0.63
15 °C	33.5	33.5	6.13	30.2	5.00	26.8	3.98	23.5	3.07	20.1	2.29	16.8	1.62	13.4	1.06	10.1	0.62

TC : Total Capacity PI : Power Input
Indoor air temperature conditions : 27.0°C dry-bulb / 19.0°C wet bulb

Heating			Compressor + Outdoor Fan Power consumption (kW)															
Outdoor Unit Dry-Bulb (°C)	Outdoor Unit Wet-Bulb (°C)	Outdoor Unit 100% Heating Capacity (kW)	100% Capacity		90% Capacity		80% Capacity		70% Capacity		60% Capacity		50% Capacity		40% Capacity		30% Capacity	
			TC	PI	TC	PI	TC	PI	TC	PI	TC	PI	TC	PI	TC	PI	TC	PI
			(kW)	(kW)	(kW)	(kW)	(kW)	(kW)	(kW)	(kW)	(kW)	(kW)	(kW)	(kW)	(kW)	(kW)	(kW)	(kW)
15.0	13.7	37.5	37.5	7.78	33.8	6.81	30.0	5.89	26.3	5.00	22.5	4.16	18.8	3.36	15.0	2.61	11.3	1.89
13.0	11.8	37.5	37.5	8.02	33.8	7.02	30.0	6.06	26.3	5.15	22.5	4.28	18.8	3.46	15.0	2.68	11.3	1.94
11.0	9.8	37.5	37.5	8.29	33.8	7.26	30.0	6.26	26.3	5.32	22.5	4.42	18.8	3.56	15.0	2.76	11.3	2.00
9.0	7.9	37.5	37.5	8.57	33.8	7.49	30.0	6.46	26.3	5.48	22.5	4.55	18.8	3.67	15.0	2.84	11.3	2.05
7.0	6.0	37.5	37.5	8.87	33.8	7.75	30.0	6.68	26.3	5.66	22.5	4.70	18.8	3.79	15.0	2.92	11.3	2.12
5.0	4.1	36.4	36.4	8.84	32.8	7.73	29.1	6.66	25.5	5.65	21.8	4.68	18.2	3.77	14.6	2.92	10.9	2.11
3.0	2.2	35.3	35.3	8.82	31.8	7.70	28.2	6.64	24.7	5.63	21.2	4.67	17.7	3.76	14.1	2.91	10.6	2.10
0.0	-0.7	33.6	33.6	8.78	30.3	7.67	26.9	6.61	23.5	5.60	20.2	4.65	16.8	3.74	13.5	2.89	10.1	2.09
-3.0	-3.7	31.9	31.9	8.73	28.7	7.63	25.5	6.58	22.3	5.58	19.1	4.63	16.0	3.73	12.8	2.88	9.57	2.08
-5.0	-5.6	30.8	30.8	8.71	27.7	7.61	24.6	6.56	21.6	5.56	18.5	4.61	15.4	3.72	12.3	2.87	9.24	2.08
-7.0	-7.6	29.7	29.7	8.68	26.7	7.58	23.7	6.53	20.8	5.54	17.8	4.60	14.8	3.70	11.9	2.86	8.90	2.07
-10	-10.5	28.0	28.0	8.64	25.2	7.54	22.4	6.50	19.6	5.51	16.8	4.57	14.0	3.69	11.2	2.85	8.39	2.06
-14.5	-15.0	25.4	25.4	8.57	22.8	7.49	20.3	6.46	17.8	5.47	15.2	4.54	12.7	3.66	10.2	2.83	7.62	2.04
-19.5	-20.0	22.5	22.5	8.50	20.3	7.43	18.0	6.40	15.8	5.43	13.5	4.50	11.3	3.63	9.00	2.80	6.75	2.03

TC : Total Capacity PI : Power Input
Indoor air temperature conditions : 20.0°C dry-bulb

MMY-MUP1401HT8P-E (14HP, 40 kW system)

Outdoor Unit Dry-Bulb (°C)		Outdoor Unit 100% Cooling Capacity (kW)	Compressor + Outdoor Fan Power consumption (kW)															
			100% Capacity		90% Capacity		80% Capacity		70% Capacity		60% Capacity		50% Capacity		40% Capacity		30% Capacity	
			TC (kW)	PI (kW)	TC (kW)	PI (kW)	TC (kW)	PI (kW)	TC (kW)	PI (kW)	TC (kW)	PI (kW)	TC (kW)	PI (kW)	TC (kW)	PI (kW)	TC (kW)	PI (kW)
46 °C		31.3	31.3	14.95	28.2	12.11	25.1	9.57	21.9	7.33	18.8	5.38	15.7	3.74	12.5	2.39	9.40	1.35
43 °C		34.4	34.4	15.23	30.9	12.34	27.5	9.75	24.1	7.46	20.6	5.48	17.2	3.81	13.7	2.44	10.3	1.37
41 °C		36.6	36.6	15.62	32.9	12.65	29.3	10.00	25.6	7.65	22.0	5.62	18.3	3.90	14.6	2.50	11.0	1.41
39 °C		37.8	37.8	15.16	34.0	12.28	30.3	9.70	26.5	7.43	22.7	5.46	18.9	3.79	15.1	2.43	11.3	1.36
37 °C		39.0	39.0	14.70	35.1	11.91	31.2	9.41	27.3	7.21	23.4	5.29	19.5	3.68	15.6	2.35	11.7	1.32
35 °C		40.0	40.0	14.55	36.0	11.54	32.0	9.12	28.0	6.98	24.0	5.13	20.0	3.56	16.0	2.28	12.0	1.28
32 °C		40.0	40.0	13.14	36.0	10.64	32.0	8.41	28.0	6.44	24.0	4.73	20.0	3.28	16.0	2.10	12.0	1.18
31 °C		40.0	40.0	12.15	36.0	9.85	32.0	7.78	28.0	5.96	24.0	4.38	20.0	3.04	16.0	1.94	12.0	1.09
30 °C		40.0	40.0	11.70	36.0	9.48	32.0	7.49	28.0	5.73	24.0	4.21	20.0	2.93	16.0	1.87	12.0	1.05
29 °C		40.0	40.0	11.28	36.0	9.13	32.0	7.22	28.0	5.53	24.0	4.06	20.0	2.82	16.0	1.80	12.0	1.01
27 °C		40.0	40.0	10.49	36.0	8.49	32.0	6.71	28.0	5.14	24.0	3.77	20.0	2.62	16.0	1.68	12.0	0.94
25 °C		40.0	40.0	9.77	36.0	7.91	32.0	6.25	28.0	4.79	24.0	3.52	20.0	2.44	16.0	1.56	12.0	0.88
23 °C		40.0	40.0	9.31	36.0	7.54	32.0	5.96	28.0	4.56	24.0	3.35	20.0	2.33	16.0	1.49	12.0	0.84
21 °C		40.0	40.0	9.09	36.0	7.36	32.0	5.82	28.0	4.45	24.0	3.27	20.0	2.27	16.0	1.45	12.0	0.82
20 °C		40.0	40.0	8.99	36.0	7.28	32.0	5.75	28.0	4.41	24.0	3.24	20.0	2.25	16.0	1.44	12.0	0.81
19 °C		40.0	40.0	8.90	36.0	7.21	32.0	5.70	28.0	4.36	24.0	3.20	20.0	2.23	16.0	1.42	12.0	0.80
17 °C		40.0	40.0	8.74	36.0	7.08	32.0	5.59	28.0	4.28	24.0	3.15	20.0	2.18	16.0	1.40	12.0	0.79
15 °C		40.0	40.0	8.60	36.0	6.97	32.0	5.51	28.0	4.22	24.0	3.10	20.0	2.15	16.0	1.38	12.0	0.77

TC : Total Capacity PI : Power Input
Indoor air temperature conditions : 27.0°C dry-bulb / 19.0°C wet bulb

Outdoor Unit Dry-Bulb (°C)		Outdoor Unit Wet-Bulb (°C)	Outdoor Unit 100% Heating Capacity (kW)	Compressor + Outdoor Fan Power consumption (kW)															
				100% Capacity		90% Capacity		80% Capacity		70% Capacity		60% Capacity		50% Capacity		40% Capacity		30% Capacity	
				TC (kW)	PI (kW)	TC (kW)	PI (kW)	TC (kW)	PI (kW)	TC (kW)	PI (kW)	TC (kW)	PI (kW)	TC (kW)	PI (kW)	TC (kW)	PI (kW)	TC (kW)	PI (kW)
15.0	13.7	45.0	45.0	10.51	40.5	9.10	36.0	7.77	31.5	6.51	27.0	5.34	22.5	4.25	18.0	3.24	13.5	2.31	
13.0	11.8	45.0	45.0	10.86	40.5	9.40	36.0	8.02	31.5	6.72	27.0	5.51	22.5	4.38	18.0	3.34	13.5	2.38	
11.0	9.8	45.0	45.0	11.27	40.5	9.74	36.0	8.31	31.5	6.96	27.0	5.70	22.5	4.53	18.0	3.44	13.5	2.45	
9.0	7.9	45.0	45.0	11.68	40.5	10.10	36.0	8.60	31.5	7.20	27.0	5.89	22.5	4.67	18.0	3.55	13.5	2.52	
7.0	6.0	45.0	45.0	12.13	40.5	10.47	36.0	8.91	31.5	7.45	27.0	6.09	22.5	4.83	18.0	3.67	13.5	2.60	
5.0	4.1	43.7	43.7	12.09	39.3	10.44	34.9	8.89	30.6	7.43	26.2	6.07	21.8	4.82	17.5	3.66	13.1	2.59	
3.0	2.2	42.4	42.4	12.06	38.1	10.41	33.9	8.86	29.7	7.41	25.4	6.06	21.2	4.80	16.9	3.64	12.7	2.59	
0.0	-0.7	40.4	40.4	12.00	36.3	10.36	32.3	8.82	28.3	7.37	24.2	6.03	20.2	4.78	16.1	3.63	12.1	2.57	
-3.0	-3.7	38.3	38.3	11.94	34.5	10.31	30.6	8.78	26.8	7.34	23.0	6.00	19.1	4.76	15.3	3.61	11.5	2.56	
-5.0	-5.6	37.0	37.0	11.91	33.3	10.28	29.6	8.75	25.9	7.32	22.2	5.98	18.5	4.74	14.8	3.60	11.1	2.55	
-7.0	-7.6	35.6	35.6	11.87	32.0	10.24	28.5	8.72	24.9	7.29	21.4	5.96	17.8	4.73	14.2	3.59	10.7	2.55	
-10	-10.5	33.6	33.6	11.81	30.2	10.20	26.9	8.68	23.5	7.26	20.1	5.93	16.8	4.70	13.4	3.57	10.1	2.53	
-14.5	-15.0	30.5	30.5	11.72	27.4	10.12	24.4	8.61	21.3	7.20	18.3	5.89	15.2	4.67	12.2	3.54	9.14	2.51	
-19.5	-20.0	27.0	27.0	11.63	24.3	10.04	21.6	8.54	18.9	7.14	16.2	5.84	13.5	4.63	10.8	3.51	8.10	2.49	

TC : Total Capacity PI : Power Input
Indoor air temperature conditions : 20.0°C dry-bulb

MMY-MUP1601HT8P-E (16HP, 45.0 kW system)

Cooling		Compressor + Outdoor Fan Power consumption (kW)															
		100% Capacity		90% Capacity		80% Capacity		70% Capacity		60% Capacity		50% Capacity		40% Capacity		30% Capacity	
		TC	PI	TC	PI	TC	PI	TC	PI	TC	PI	TC	PI	TC	PI	TC	PI
Outdoor Unit Dry-Bulb (°C)	Outdoor Unit 100% Cooling Capacity (kW)	(kW)	(kW)	(kW)	(kW)	(kW)	(kW)	(kW)	(kW)	(kW)	(kW)	(kW)	(kW)	(kW)	(kW)	(kW)	(kW)
46 °C	35.2	35.2	14.56	31.7	11.84	28.2	9.40	24.7	7.25	21.1	5.38	17.6	3.81	14.1	2.51	10.6	1.51
43 °C	38.7	38.7	14.82	34.8	12.05	30.9	9.56	27.1	7.37	23.2	5.47	19.3	3.86	15.5	2.55	11.6	1.53
41 °C	41.2	41.2	15.19	37.1	12.34	32.9	9.79	28.8	7.54	24.7	5.60	20.6	3.95	16.5	2.60	12.4	1.55
39 °C	42.5	42.5	14.74	38.3	11.98	34.0	9.51	29.8	7.33	25.5	5.43	21.3	3.83	17.0	2.53	12.8	1.51
37 °C	43.8	43.8	14.30	39.4	11.62	35.1	9.22	30.7	7.10	26.3	5.27	21.9	3.72	17.5	2.45	13.1	1.46
35 °C	45.0	45.0	14.06	40.5	11.25	36.0	8.93	31.5	6.88	27.0	5.11	22.5	3.60	18.0	2.37	13.5	1.42
32 °C	45.0	45.0	12.78	40.5	10.39	36.0	8.24	31.5	6.35	27.0	4.72	22.5	3.33	18.0	2.20	13.5	1.31
31 °C	45.0	45.0	11.83	40.5	9.62	36.0	7.64	31.5	5.89	27.0	4.37	22.5	3.09	18.0	2.04	13.5	1.22
30 °C	45.0	45.0	11.40	40.5	9.26	36.0	7.36	31.5	5.67	27.0	4.21	22.5	2.98	18.0	1.97	13.5	1.18
29 °C	45.0	45.0	10.98	40.5	8.93	36.0	7.09	31.5	5.47	27.0	4.06	22.5	2.87	18.0	1.90	13.5	1.14
27 °C	45.0	45.0	10.22	40.5	8.31	36.0	6.60	31.5	5.09	27.0	3.78	22.5	2.68	18.0	1.77	13.5	1.07
25 °C	45.0	45.0	9.52	40.5	7.74	36.0	6.15	31.5	4.75	27.0	3.53	22.5	2.50	18.0	1.65	13.5	1.00
23 °C	45.0	45.0	9.08	40.5	7.38	36.0	5.87	31.5	4.53	27.0	3.37	22.5	2.38	18.0	1.58	13.5	0.95
21 °C	45.0	45.0	8.87	40.5	7.21	36.0	5.73	31.5	4.42	27.0	3.29	22.5	2.33	18.0	1.55	13.5	0.94
20 °C	45.0	45.0	8.78	40.5	7.14	36.0	5.67	31.5	4.38	27.0	3.26	22.5	2.31	18.0	1.53	13.5	0.93
19 °C	45.0	45.0	8.69	40.5	7.07	36.0	5.62	31.5	4.34	27.0	3.23	22.5	2.29	18.0	1.52	13.5	0.92
17 °C	45.0	45.0	8.54	40.5	6.94	36.0	5.52	31.5	4.26	27.0	3.17	22.5	2.25	18.0	1.49	13.5	0.91
15 °C	45.0	45.0	8.40	40.5	6.84	36.0	5.43	31.5	4.19	27.0	3.12	22.5	2.21	18.0	1.47	13.5	0.89

TC : Total Capacity PI : Power Input
 Indoor air temperature conditions : 27.0°C dry-bulb / 19.0°C wet bulb

Heating		Compressor + Outdoor Fan Power consumption (kW)																
		100% Capacity		90% Capacity		80% Capacity		70% Capacity		60% Capacity		50% Capacity		40% Capacity		30% Capacity		
		TC	PI	TC	PI	TC	PI	TC	PI	TC	PI	TC	PI	TC	PI	TC	PI	
Outdoor Unit Dry-Bulb (°C)	Outdoor Unit Wet-Bulb (°C)	Outdoor Unit 100% Heating Capacity (kW)	(kW)	(kW)	(kW)	(kW)	(kW)	(kW)	(kW)	(kW)	(kW)	(kW)	(kW)	(kW)	(kW)	(kW)	(kW)	(kW)
15.0	13.7	50.0	50.0	11.99	45.0	10.28	40.0	8.69	35.0	7.23	30.0	5.90	25.0	4.70	20.0	3.62	15.0	2.67
13.0	11.8	50.0	50.0	12.43	45.0	10.65	40.0	9.00	35.0	7.48	30.0	6.09	25.0	4.84	20.0	3.72	15.0	2.73
11.0	9.8	50.0	50.0	12.94	45.0	11.07	40.0	9.34	35.0	7.75	30.0	6.30	25.0	5.00	20.0	3.83	15.0	2.81
9.0	7.9	50.0	50.0	13.45	45.0	11.50	40.0	9.69	35.0	8.03	30.0	6.52	25.0	5.16	20.0	3.94	15.0	2.88
7.0	6.0	50.0	50.0	14.01	45.0	11.96	40.0	10.07	35.0	8.33	30.0	6.75	25.0	5.33	20.0	4.07	15.0	2.96
5.0	4.1	48.5	48.5	13.97	43.7	11.92	38.8	10.04	34.0	8.31	29.1	6.73	24.3	5.32	19.4	4.05	14.6	2.95
3.0	2.2	47.1	47.1	13.93	42.4	11.89	37.7	10.01	33.0	8.28	28.2	6.71	23.5	5.30	18.8	4.04	14.1	2.94
0.0	-0.7	44.8	44.8	13.86	40.4	11.83	35.9	9.96	31.4	8.24	26.9	6.68	22.4	5.27	17.9	4.02	13.5	2.93
-3.0	-3.7	42.5	42.5	13.79	38.3	11.78	34.0	9.91	29.8	8.20	25.5	6.65	21.3	5.25	17.0	4.00	12.8	2.91
-5.0	-5.6	41.1	41.1	13.75	37.0	11.74	32.9	9.88	28.8	8.18	24.6	6.63	20.5	5.23	16.4	3.99	12.3	2.90
-7.0	-7.6	39.5	39.5	13.71	35.6	11.70	31.6	9.85	27.7	8.15	23.7	6.61	19.8	5.22	15.8	3.98	11.9	2.89
-10	-10.5	37.3	37.3	13.64	33.6	11.65	29.8	9.80	26.1	8.11	22.4	6.58	18.7	5.19	14.9	3.96	11.2	2.88
-14.5	-15.0	33.8	33.8	13.54	30.5	11.56	27.1	9.73	23.7	8.05	20.3	6.53	16.9	5.15	13.5	3.93	10.2	2.86
-19.5	-20.0	30.0	30.0	13.43	27.0	11.46	24.0	9.65	21.0	7.99	18.0	6.47	15.0	5.11	12.0	3.90	9.0	2.83

TC : Total Capacity PI : Power Input
 Indoor air temperature conditions : 20.0°C dry-bulb

MMY-MUP1801HT8P-E (18HP, 50.4 kW system)

Cooling		Compressor + Outdoor Fan Power consumption (kW)															
		100% Capacity		90% Capacity		80% Capacity		70% Capacity		60% Capacity		50% Capacity		40% Capacity		30% Capacity	
		TC	PI	TC	PI	TC	PI	TC	PI	TC	PI	TC	PI	TC	PI	TC	PI
Outdoor Unit Dry-Bulb (°C)	Outdoor Unit 100% Cooling Capacity (kW)	(kW)	(kW)	(kW)	(kW)	(kW)	(kW)	(kW)	(kW)	(kW)	(kW)	(kW)	(kW)	(kW)	(kW)	(kW)	
46 °C	39.5	39.5	16.59	35.5	13.49	31.6	10.71	27.6	8.25	23.7	6.11	19.7	4.29	15.8	2.79	11.8	1.61
43 °C	43.3	43.3	16.88	39.0	13.72	34.6	10.89	30.3	8.39	26.0	6.21	21.6	4.36	17.3	2.83	13.0	1.64
41 °C	46.1	46.1	17.29	41.5	14.06	36.9	11.16	32.3	8.59	27.7	6.36	23.1	4.46	18.4	2.90	13.8	1.67
39 °C	47.7	47.7	16.79	42.9	13.65	38.1	10.83	33.4	8.34	28.6	6.17	23.8	4.33	19.1	2.82	14.3	1.62
37 °C	49.1	49.1	16.28	44.2	13.23	39.3	10.50	34.4	8.09	29.4	5.99	24.5	4.20	19.6	2.73	14.7	1.57
35 °C	50.4	50.4	15.90	45.4	12.82	40.3	10.17	35.3	7.83	30.2	5.80	25.2	4.07	20.2	2.64	15.1	1.53
32 °C	50.4	50.4	14.56	45.4	11.83	40.3	9.39	35.3	7.23	30.2	5.35	25.2	3.76	20.2	2.44	15.1	1.41
31 °C	50.4	50.4	13.48	45.4	10.96	40.3	8.70	35.3	6.70	30.2	4.96	25.2	3.48	20.2	2.26	15.1	1.31
30 °C	50.4	50.4	12.98	45.4	10.55	40.3	8.38	35.3	6.45	30.2	4.78	25.2	3.35	20.2	2.18	15.1	1.26
29 °C	50.4	50.4	12.51	45.4	10.17	40.3	8.08	35.3	6.22	30.2	4.61	25.2	3.23	20.2	2.10	15.1	1.22
27 °C	50.4	50.4	11.64	45.4	9.47	40.3	7.51	35.3	5.79	30.2	4.29	25.2	3.01	20.2	1.96	15.1	1.13
25 °C	50.4	50.4	10.85	45.4	8.82	40.3	7.00	35.3	5.40	30.2	4.00	25.2	2.81	20.2	1.83	15.1	1.06
23 °C	50.4	50.4	10.34	45.4	8.41	40.3	6.68	35.3	5.15	30.2	3.81	25.2	2.68	20.2	1.74	15.1	1.01
21 °C	50.4	50.4	10.10	45.4	8.22	40.3	6.53	35.3	5.03	30.2	3.72	25.2	2.62	20.2	1.70	15.1	0.99
20 °C	50.4	50.4	10.00	45.4	8.13	40.3	6.46	35.3	4.97	30.2	3.69	25.2	2.59	20.2	1.69	15.1	0.98
19 °C	50.4	50.4	9.90	45.4	8.05	40.3	6.39	35.3	4.93	30.2	3.65	25.2	2.56	20.2	1.67	15.1	0.97
17 °C	50.4	50.4	9.72	45.4	7.91	40.3	6.28	35.3	4.84	30.2	3.59	25.2	2.52	20.2	1.64	15.1	0.95
15 °C	50.4	50.4	9.57	45.4	7.79	40.3	6.18	35.3	4.76	30.2	3.53	25.2	2.48	20.2	1.62	15.1	0.94

TC : Total Capacity PI : Power Input
 Indoor air temperature conditions : 27.0°C dry-bulb / 19.0°C wet bulb

Heating		Compressor + Outdoor Fan Power consumption (kW)																
		100% Capacity		90% Capacity		80% Capacity		70% Capacity		60% Capacity		50% Capacity		40% Capacity		30% Capacity		
		TC	PI	TC	PI	TC	PI	TC	PI	TC	PI	TC	PI	TC	PI	TC	PI	
Outdoor Unit Dry-Bulb (°C)	Outdoor Unit Wet-Bulb (°C)	Outdoor Unit 100% Heating Capacity (kW)	(kW)	(kW)	(kW)	(kW)	(kW)	(kW)	(kW)	(kW)	(kW)	(kW)	(kW)	(kW)	(kW)	(kW)		
15.0	13.7	56.0	56.0	12.90	50.4	11.24	44.8	9.67	39.2	8.17	33.6	6.76	28.0	5.43	22.4	4.18	16.8	3.01
13.0	11.8	56.0	56.0	13.31	50.4	11.60	44.8	9.97	39.2	8.42	33.6	6.96	28.0	5.59	22.4	4.30	16.8	3.10
11.0	9.8	56.0	56.0	13.78	50.4	12.00	44.8	10.31	39.2	8.70	33.6	7.19	28.0	5.76	22.4	4.43	16.8	3.19
9.0	7.9	56.0	56.0	14.26	50.4	12.41	44.8	10.65	39.2	8.99	33.6	7.42	28.0	5.94	22.4	4.56	16.8	3.28
7.0	6.0	56.0	56.0	14.78	50.4	12.85	44.8	11.02	39.2	9.29	33.6	7.66	28.0	6.13	22.4	4.71	16.8	3.38
5.0	4.1	54.4	54.4	14.74	48.9	12.81	43.5	10.99	38.1	9.26	32.6	7.64	27.2	6.12	21.7	4.69	16.3	3.37
3.0	2.2	52.7	52.7	14.69	47.5	12.77	42.2	10.95	36.9	9.23	31.6	7.62	26.4	6.10	21.1	4.68	15.8	3.36
0.0	-0.7	50.2	50.2	14.62	45.2	12.71	40.2	10.90	35.2	9.19	30.1	7.58	25.1	6.07	20.1	4.66	15.1	3.34
-3.0	-3.7	47.6	47.6	14.55	42.9	12.65	38.1	10.85	33.4	9.15	28.6	7.54	23.8	6.04	19.1	4.63	14.3	3.33
-5.0	-5.6	46.0	46.0	14.51	41.4	12.61	36.8	10.82	32.2	9.12	27.6	7.52	23.0	6.02	18.4	4.62	13.8	3.32
-7.0	-7.6	44.3	44.3	14.46	39.9	12.57	35.4	10.78	31.0	9.09	26.6	7.50	22.1	6.00	17.7	4.60	13.3	3.31
-10	-10.5	41.8	41.8	14.39	37.6	12.51	33.4	10.73	29.2	9.05	25.1	7.46	20.9	5.97	16.7	4.58	12.5	3.29
-14.5	-15.0	37.9	37.9	14.28	34.1	12.42	30.3	10.65	26.5	8.98	22.7	7.40	19.0	5.93	15.2	4.55	11.4	3.27
-19.5	-20.0	33.6	33.6	14.17	30.2	12.32	26.9	10.56	23.5	8.90	20.2	7.34	16.8	5.88	13.4	4.51	10.1	3.24

TC : Total Capacity PI : Power Input
 Indoor air temperature conditions : 20.0°C dry-bulb



MMY-MUP2001HT8P-E (20HP, 56.0 kW system)

Cooling		Compressor + Outdoor Fan Power consumption (kW)																	
		Outdoor Unit 100% Cooling Capacity (kW)		100% Capacity		90% Capacity		80% Capacity		70% Capacity		60% Capacity		50% Capacity		40% Capacity		30% Capacity	
		TC (kW)	PI (kW)	TC (kW)	PI (kW)	TC (kW)	PI (kW)	TC (kW)	PI (kW)	TC (kW)	PI (kW)	TC (kW)	PI (kW)	TC (kW)	PI (kW)	TC (kW)	PI (kW)	TC (kW)	PI (kW)
46 °C		43.9	43.9	18.52	39.5	15.01	35.1	11.87	30.7	9.10	26.3	6.70	21.9	4.66	17.5	3.00	13.2	1.71	
43 °C		48.1	48.1	18.86	43.3	15.29	38.5	12.09	33.7	9.26	28.9	6.82	24.1	4.75	19.2	3.05	14.4	1.74	
41 °C		51.2	51.2	19.33	46.1	15.67	41.0	12.39	35.9	9.50	30.7	6.99	25.6	4.87	20.5	3.13	15.4	1.78	
39 °C		52.9	52.9	18.77	47.7	15.21	42.4	12.03	37.1	9.22	31.8	6.78	26.5	4.72	21.2	3.04	15.9	1.73	
37 °C		54.5	54.5	18.20	49.1	14.75	43.6	11.66	38.2	8.94	32.7	6.58	27.3	4.58	21.8	2.95	16.4	1.67	
35 °C		56.0	56.0	18.01	50.4	14.29	44.8	11.30	39.2	8.66	33.6	6.37	28.0	4.44	22.4	2.85	16.8	1.62	
32 °C		56.0	56.0	16.26	50.4	13.18	44.8	10.42	39.2	7.99	33.6	5.88	28.0	4.09	22.4	2.63	16.8	1.50	
31 °C		56.0	56.0	15.05	50.4	12.20	44.8	9.65	39.2	7.39	33.6	5.44	28.0	3.79	22.4	2.44	16.8	1.39	
30 °C		56.0	56.0	14.49	50.4	11.75	44.8	9.29	39.2	7.12	33.6	5.24	28.0	3.65	22.4	2.35	16.8	1.34	
29 °C		56.0	56.0	13.96	50.4	11.32	44.8	8.95	39.2	6.86	33.6	5.05	28.0	3.52	22.4	2.26	16.8	1.29	
27 °C		56.0	56.0	12.99	50.4	10.52	44.8	8.32	39.2	6.38	33.6	4.70	28.0	3.27	22.4	2.11	16.8	1.20	
25 °C		56.0	56.0	12.10	50.4	9.80	44.8	7.75	39.2	5.94	33.6	4.38	28.0	3.05	22.4	1.96	16.8	1.12	
23 °C		56.0	56.0	11.53	50.4	9.34	44.8	7.39	39.2	5.67	33.6	4.17	28.0	2.91	22.4	1.87	16.8	1.07	
21 °C		56.0	56.0	11.26	50.4	9.13	44.8	7.22	39.2	5.53	33.6	4.07	28.0	2.84	22.4	1.83	16.8	1.04	
20 °C		56.0	56.0	11.14	50.4	9.03	44.8	7.14	39.2	5.47	33.6	4.03	28.0	2.81	22.4	1.81	16.8	1.03	
19 °C		56.0	56.0	11.03	50.4	8.94	44.8	7.07	39.2	5.42	33.6	3.99	28.0	2.78	22.4	1.79	16.8	1.02	
17 °C		56.0	56.0	10.83	50.4	8.78	44.8	6.94	39.2	5.32	33.6	3.92	28.0	2.73	22.4	1.76	16.8	1.00	
15 °C		56.0	56.0	10.66	50.4	8.64	44.8	6.83	39.2	5.24	33.6	3.86	28.0	2.69	22.4	1.73	16.8	0.99	

TC : Total Capacity PI : Power Input
 Indoor air temperature conditions : 27.0°C dry-bulb / 19.0°C wet bulb

Heating		Compressor + Outdoor Fan Power consumption (kW)																	
		Outdoor Unit 100% Heating Capacity (kW)		100% Capacity		90% Capacity		80% Capacity		70% Capacity		60% Capacity		50% Capacity		40% Capacity		30% Capacity	
		TC (kW)	PI (kW)	TC (kW)	PI (kW)	TC (kW)	PI (kW)	TC (kW)	PI (kW)	TC (kW)	PI (kW)	TC (kW)	PI (kW)	TC (kW)	PI (kW)	TC (kW)	PI (kW)	TC (kW)	PI (kW)
15.0	13.7	63.0	63.0	15.39	56.7	13.38	50.4	11.48	44.1	9.69	37.8	8.02	31.5	6.45	25.2	5.00	18.9	3.66	
13.0	11.8	63.0	63.0	15.90	56.7	13.81	50.4	11.84	44.1	9.99	37.8	8.26	31.5	6.64	25.2	5.14	18.9	3.76	
11.0	9.8	63.0	63.0	16.48	56.7	14.30	50.4	12.25	44.1	10.32	37.8	8.52	31.5	6.84	25.2	5.29	18.9	3.86	
9.0	7.9	63.0	63.0	17.07	56.7	14.80	50.4	12.67	44.1	10.67	37.8	8.79	31.5	7.05	25.2	5.44	18.9	3.97	
7.0	6.0	63.0	63.0	17.70	56.7	15.34	50.4	13.12	44.1	11.03	37.8	9.09	31.5	7.28	25.2	5.61	18.9	4.08	
5.0	4.1	61.2	61.2	17.65	55.0	15.29	48.9	13.08	42.8	11.00	36.7	9.06	30.6	7.26	24.5	5.59	18.3	4.07	
3.0	2.2	59.3	59.3	17.59	53.4	15.25	47.5	13.04	41.5	10.96	35.6	9.03	29.7	7.23	23.7	5.57	17.8	4.05	
0.0	-0.7	56.5	56.5	17.51	50.9	15.17	45.2	12.98	39.6	10.91	33.9	8.99	28.3	7.20	22.6	5.55	17.0	4.03	
-3.0	-3.7	53.6	53.6	17.43	48.2	15.10	42.9	12.91	37.5	10.86	32.2	8.94	26.8	7.16	21.4	5.52	16.1	4.01	
-5.0	-5.6	51.8	51.8	17.37	46.6	15.05	41.4	12.87	36.2	10.83	31.1	8.92	25.9	7.14	20.7	5.50	15.5	4.00	
-7.0	-7.6	49.8	49.8	17.32	44.8	15.01	39.9	12.83	34.9	10.79	29.9	8.89	24.9	7.12	19.9	5.49	14.9	3.99	
-10	-10.5	47.0	47.0	17.23	42.3	14.93	37.6	12.77	32.9	10.74	28.2	8.85	23.5	7.09	18.8	5.46	14.1	3.97	
-14.5	-15.0	42.6	42.6	17.11	38.4	14.82	34.1	12.68	29.9	10.66	25.6	8.78	21.3	7.03	17.1	5.42	12.8	3.94	
-19.5	-20.0	37.8	37.8	16.96	34.0	14.70	30.2	12.57	26.5	10.57	22.7	8.71	18.9	6.97	15.1	5.38	11.3	3.91	

TC : Total Capacity PI : Power Input
 Indoor air temperature conditions : 20.0°C dry-bulb

MMY-MUP2201HT8P-E (22HP, 61.5 kW system)

Cooling			Compressor + Outdoor Fan Power consumption (kW)															
			100% Capacity		90% Capacity		80% Capacity		70% Capacity		60% Capacity		50% Capacity		40% Capacity		30% Capacity	
			TC	PI	TC	PI	TC	PI	TC	PI	TC	PI	TC	PI	TC	PI	TC	PI
Outdoor Unit Dry-Bulb (°C)	Outdoor Unit 100% Cooling Capacity (kW)	(kW)	(kW)	(kW)	(kW)	(kW)	(kW)	(kW)	(kW)	(kW)	(kW)	(kW)	(kW)	(kW)	(kW)	(kW)	(kW)	
46 °C	48.2	48.2	21.01	43.4	17.04	38.5	13.49	33.7	10.36	28.9	7.64	24.1	5.34	19.3	3.46	14.5	2.00	
43 °C	52.8	52.8	21.40	47.5	17.35	42.3	13.74	37.0	10.54	31.7	7.78	26.4	5.44	21.1	3.52	15.8	2.03	
41 °C	56.3	56.3	21.93	50.6	17.79	45.0	14.08	39.4	10.80	33.8	7.97	28.1	5.57	22.5	3.60	16.9	2.08	
39 °C	58.2	58.2	21.29	52.3	17.27	46.5	13.67	40.7	10.49	34.9	7.74	29.1	5.41	23.3	3.50	17.4	2.02	
37 °C	59.9	59.9	20.65	53.9	16.75	47.9	13.25	41.9	10.17	35.9	7.50	29.9	5.24	24.0	3.39	18.0	1.96	
35 °C	61.5	61.5	20.43	55.4	16.22	49.2	12.84	43.1	9.85	36.9	7.27	30.8	5.08	24.6	3.29	18.5	1.89	
32 °C	61.5	61.5	18.45	55.4	14.96	49.2	11.84	43.1	9.09	36.9	6.71	30.8	4.69	24.6	3.04	18.5	1.75	
31 °C	61.5	61.5	17.08	55.4	13.85	49.2	10.96	43.1	8.42	36.9	6.21	30.8	4.34	24.6	2.81	18.5	1.62	
30 °C	61.5	61.5	16.44	55.4	13.34	49.2	10.56	43.1	8.11	36.9	5.98	30.8	4.18	24.6	2.71	18.5	1.57	
29 °C	61.5	61.5	15.85	55.4	12.85	49.2	10.18	43.1	7.81	36.9	5.76	30.8	4.03	24.6	2.61	18.5	1.51	
27 °C	61.5	61.5	14.74	55.4	11.95	49.2	9.46	43.1	7.27	36.9	5.36	30.8	3.75	24.6	2.43	18.5	1.41	
25 °C	61.5	61.5	13.73	55.4	11.14	49.2	8.82	43.1	6.77	36.9	5.00	30.8	3.50	24.6	2.27	18.5	1.31	
23 °C	61.5	61.5	13.09	55.4	10.62	49.2	8.41	43.1	6.46	36.9	4.76	30.8	3.33	24.6	2.16	18.5	1.25	
21 °C	61.5	61.5	12.78	55.4	10.37	49.2	8.21	43.1	6.31	36.9	4.66	30.8	3.26	24.6	2.12	18.5	1.23	
20 °C	61.5	61.5	12.64	55.4	10.26	49.2	8.12	43.1	6.24	36.9	4.61	30.8	3.22	24.6	2.09	18.5	1.21	
19 °C	61.5	61.5	12.52	55.4	10.16	49.2	8.04	43.1	6.18	36.9	4.56	30.8	3.19	24.6	2.07	18.5	1.20	
17 °C	61.5	61.5	12.29	55.4	9.97	49.2	7.90	43.1	6.07	36.9	4.48	30.8	3.14	24.6	2.04	18.5	1.18	
15 °C	61.5	61.5	12.10	55.4	9.82	49.2	7.77	43.1	5.97	36.9	4.41	30.8	3.09	24.6	2.01	18.5	1.17	

TC : Total Capacity PI : Power Input
 Indoor air temperature conditions : 27.0°C dry-bulb / 19.0°C wet bulb

Heating			Compressor + Outdoor Fan Power consumption (kW)															
			100% Capacity		90% Capacity		80% Capacity		70% Capacity		60% Capacity		50% Capacity		40% Capacity		30% Capacity	
			TC	PI	TC	PI	TC	PI	TC	PI	TC	PI	TC	PI	TC	PI	TC	PI
Outdoor Unit Dry-Bulb (°C)	Outdoor Unit Wet-Bulb (°C)	Outdoor Unit 100% Heating Capacity (kW)	(kW)	(kW)	(kW)	(kW)	(kW)	(kW)	(kW)	(kW)	(kW)	(kW)	(kW)	(kW)	(kW)	(kW)	(kW)	(kW)
15.0	13.7	69.0	69.0	16.70	62.1	14.65	55.2	12.68	48.3	10.80	41.4	9.00	34.5	7.29	27.6	5.66	20.7	4.12
13.0	11.8	69.0	69.0	17.22	62.1	15.09	55.2	13.06	48.3	11.11	41.4	9.26	34.5	7.49	27.6	5.81	20.7	4.23
11.0	9.8	69.0	69.0	17.79	62.1	15.59	55.2	13.48	48.3	11.47	41.4	9.54	34.5	7.72	27.6	5.99	20.7	4.35
9.0	7.9	69.0	69.0	18.38	62.1	16.10	55.2	13.91	48.3	11.82	41.4	9.84	34.5	7.95	27.6	6.16	20.7	4.47
7.0	6.0	69.0	69.0	19.01	62.1	16.64	55.2	14.37	48.3	12.20	41.4	10.15	34.5	8.19	27.6	6.34	20.7	4.60
5.0	4.1	67.0	67.0	18.95	60.3	16.59	53.6	14.32	46.9	12.17	40.2	10.12	33.5	8.17	26.8	6.32	20.1	4.59
3.0	2.2	65.0	65.0	18.89	58.5	16.54	52.0	14.28	45.5	12.13	39.0	10.08	32.5	8.14	26.0	6.31	19.5	4.57
0.0	-0.7	61.9	61.9	18.81	55.7	16.46	49.5	14.21	43.3	12.07	37.1	10.04	30.9	8.10	24.8	6.28	18.6	4.55
-3.0	-3.7	58.7	58.7	18.72	52.8	16.38	47.0	14.15	41.1	12.02	35.2	9.99	29.4	8.07	23.5	6.25	17.6	4.53
-5.0	-5.6	56.7	56.7	18.66	51.0	16.33	45.3	14.10	39.7	11.98	34.0	9.96	28.3	8.04	22.7	6.23	17.0	4.51
-7.0	-7.6	54.6	54.6	18.60	49.1	16.27	43.7	14.06	38.2	11.94	32.7	9.93	27.3	8.01	21.8	6.21	16.4	4.50
-10	-10.5	51.5	51.5	18.51	46.3	16.20	41.2	13.99	36.0	11.88	30.9	9.88	25.7	7.98	20.6	6.18	15.4	4.48
-14.5	-15.0	46.7	46.7	18.37	42.0	16.08	37.4	13.89	32.7	11.79	28.0	9.81	23.4	7.92	18.7	6.13	14.0	4.45
-19.5	-20.0	41.4	41.4	18.22	37.3	15.94	33.1	13.77	29.0	11.70	24.8	9.72	20.7	7.85	16.6	6.08	12.4	4.41

TC : Total Capacity PI : Power Input
 Indoor air temperature conditions : 20.0°C dry-bulb

MMY-MUP2401HT8P-E1 (24HP, 67.0 kW system)

Cooling

Outdoor Unit Dry-Bulb (°C)			Outdoor Unit 100% Cooling Capacity (kW)		Compressor + Outdoor Fan Power consumption (kW)															
					100% Capacity		90% Capacity		80% Capacity		70% Capacity		60% Capacity		50% Capacity		40% Capacity		30% Capacity	
					TC (kW)	PI (kW)	TC (kW)	PI (kW)	TC (kW)	PI (kW)	TC (kW)	PI (kW)	TC (kW)	PI (kW)	TC (kW)	PI (kW)	TC (kW)	PI (kW)	TC (kW)	PI (kW)
46 °C			52.5	24.87	47.2	20.14	42.0	15.92	36.7	12.19	31.5	8.95	26.2	6.22	21.0	3.98	15.7	2.24		
43 °C			57.6	25.33	51.8	20.52	46.0	16.21	40.3	12.41	34.5	9.12	28.8	6.33	23.0	4.05	17.3	2.28		
41 °C			61.3	25.97	55.2	21.04	49.0	16.62	42.9	12.73	36.8	9.35	30.7	6.49	24.5	4.16	18.4	2.34		
39 °C			63.4	25.22	57.0	20.43	50.7	16.14	44.3	12.36	38.0	9.08	31.7	6.30	25.3	4.03	19.0	2.27		
37 °C			65.2	24.45	58.7	19.81	52.2	15.65	45.7	11.98	39.1	8.80	32.6	6.11	26.1	3.91	19.6	2.20		
35 °C			67.0	24.19	60.3	19.19	53.6	15.16	46.9	11.61	40.2	8.53	33.5	5.92	26.8	3.79	20.1	2.13		
32 °C			67.0	21.84	60.3	17.69	53.6	13.98	46.9	10.70	40.2	7.86	33.5	5.46	26.8	3.50	20.1	1.97		
31 °C			67.0	20.21	60.3	16.37	53.6	12.94	46.9	9.90	40.2	7.28	33.5	5.05	26.8	3.23	20.1	1.82		
30 °C			67.0	19.46	60.3	15.76	53.6	12.46	46.9	9.54	40.2	7.01	33.5	4.87	26.8	3.11	20.1	1.75		
29 °C			67.0	18.75	60.3	15.19	53.6	12.00	46.9	9.19	40.2	6.75	33.5	4.69	26.8	3.00	20.1	1.69		
27 °C			67.0	17.44	60.3	14.12	53.6	11.16	46.9	8.54	40.2	6.28	33.5	4.36	26.8	2.79	20.1	1.57		
25 °C			67.0	16.24	60.3	13.15	53.6	10.39	46.9	7.96	40.2	5.85	33.5	4.06	26.8	2.60	20.1	1.46		
23 °C			67.0	15.48	60.3	12.54	53.6	9.91	46.9	7.58	40.2	5.57	33.5	3.87	26.8	2.48	20.1	1.39		
21 °C			67.0	15.11	60.3	12.24	53.6	9.67	46.9	7.41	40.2	5.44	33.5	3.78	26.8	2.42	20.1	1.36		
20 °C			67.0	14.95	60.3	12.11	53.6	9.57	46.9	7.33	40.2	5.38	33.5	3.74	26.8	2.39	20.1	1.35		
19 °C			67.0	14.80	60.3	11.99	53.6	9.47	46.9	7.25	40.2	5.33	33.5	3.70	26.8	2.37	20.1	1.33		
17 °C			67.0	14.53	60.3	11.77	53.6	9.30	46.9	7.12	40.2	5.23	33.5	3.63	26.8	2.33	20.1	1.31		
15 °C			67.0	14.30	60.3	11.59	53.6	9.16	46.9	7.01	40.2	5.15	33.5	3.58	26.8	2.29	20.1	1.29		

TC : Total Capacity PI : Power Input
 Indoor air temperature conditions : 27.0°C dry-bulb / 19.0°C wet bulb

Heating

Outdoor Unit Dry-Bulb (°C)		Outdoor Unit Wet-Bulb (°C)		Outdoor Unit 100% Heating Capacity (kW)		Compressor + Outdoor Fan Power consumption (kW)															
						100% Capacity		90% Capacity		80% Capacity		70% Capacity		60% Capacity		50% Capacity		40% Capacity		30% Capacity	
						TC (kW)	PI (kW)	TC (kW)	PI (kW)	TC (kW)	PI (kW)	TC (kW)	PI (kW)	TC (kW)	PI (kW)	TC (kW)	PI (kW)	TC (kW)	PI (kW)	TC (kW)	PI (kW)
15.0	13.7	70.0	70.0	18.52	63.0	16.46	56.0	14.44	49.0	12.47	42.0	10.55	35.0	8.67	28.0	6.85	21.0	5.06			
13.0	11.8	70.0	70.0	19.03	63.0	16.90	56.0	14.83	49.0	12.80	42.0	10.82	35.0	8.90	28.0	7.02	21.0	5.19			
11.0	9.8	70.0	70.0	19.59	63.0	17.40	56.0	15.26	49.0	13.17	42.0	11.13	35.0	9.15	28.0	7.21	21.0	5.33			
9.0	7.9	70.0	70.0	20.16	63.0	17.90	56.0	15.69	49.0	13.54	42.0	11.44	35.0	9.40	28.0	7.41	21.0	5.47			
7.0	6.0	70.0	70.0	20.77	63.0	18.43	56.0	16.15	49.0	13.93	42.0	11.77	35.0	9.66	28.0	7.61	21.0	5.62			
5.0	4.1	68.0	68.0	20.71	61.2	18.38	54.4	16.10	47.6	13.89	40.8	11.73	34.0	9.63	27.2	7.59	20.4	5.61			
3.0	2.2	65.9	65.9	20.64	59.3	18.32	52.7	16.05	46.1	13.85	39.5	11.70	33.0	9.60	26.4	7.57	19.8	5.59			
0.0	-0.7	62.8	62.8	20.55	56.5	18.24	50.2	15.98	43.9	13.78	37.7	11.64	31.4	9.56	25.1	7.53	18.8	5.56			
-3.0	-3.7	59.6	59.6	20.45	53.6	18.15	47.6	15.90	41.7	13.71	35.7	11.58	29.8	9.51	23.8	7.50	17.9	5.54			
-5.0	-5.6	57.5	57.5	20.38	51.8	18.09	46.0	15.85	40.3	13.67	34.5	11.55	28.8	9.48	23.0	7.47	17.3	5.52			
-7.0	-7.6	55.4	55.4	20.32	49.8	18.03	44.3	15.80	38.7	13.63	33.2	11.51	27.7	9.45	22.1	7.45	16.6	5.50			
-10	-10.5	52.2	52.2	20.22	47.0	17.95	41.8	15.73	36.6	13.56	31.3	11.46	26.1	9.41	20.9	7.41	15.7	5.47			
-14.5	-15.0	47.4	47.4	20.07	42.6	17.81	37.9	15.61	33.2	13.46	28.4	11.37	23.7	9.34	19.0	7.36	14.2	5.43			
-19.5	-20.0	42.0	42.0	19.91	37.8	17.67	33.6	15.48	29.4	13.35	25.2	11.28	21.0	9.26	16.8	7.30	12.6	5.39			

TC : Total Capacity PI : Power Input
 Indoor air temperature conditions : 20.0°C dry-bulb

MMY-UP2611HT8P-E (26HP, 73.5 kW system)

Cooling		Compressor + Outdoor Fan Power consumption (kW)															
		100% Capacity		90% Capacity		80% Capacity		70% Capacity		60% Capacity		50% Capacity		40% Capacity		30% Capacity	
		TC	PI	TC	PI	TC	PI	TC	PI	TC	PI	TC	PI	TC	PI	TC	PI
Outdoor Unit Dry-Bulb (°C)	Outdoor Unit 100% Cooling Capacity (kW)	(kW)	(kW)	(kW)	(kW)	(kW)	(kW)	(kW)	(kW)	(kW)	(kW)	(kW)	(kW)	(kW)	(kW)	(kW)	
46 °C	57.6	57.6	25.56	51.8	20.75	46.1	16.44	40.3	12.64	34.5	9.33	28.8	6.52	23.0	4.22	17.3	2.41
43 °C	63.1	63.1	26.02	56.8	21.13	50.5	16.74	44.2	12.86	37.9	9.49	31.6	6.64	25.3	4.29	18.9	2.45
41 °C	67.3	67.3	26.67	60.5	21.65	53.8	17.15	47.1	13.18	40.4	9.72	33.6	6.80	26.9	4.39	20.2	2.51
39 °C	69.5	69.5	25.89	62.5	21.02	55.6	16.65	48.6	12.79	41.7	9.44	34.7	6.60	27.8	4.26	20.8	2.44
37 °C	71.6	71.6	25.11	64.4	20.38	57.3	16.15	50.1	12.40	42.9	9.16	35.8	6.40	28.6	4.13	21.5	2.36
35 °C	73.5	73.5	24.89	66.2	19.74	58.8	15.64	51.5	12.02	44.1	8.87	36.8	6.20	29.4	4.00	22.1	2.29
32 °C	73.5	73.5	22.44	66.2	18.22	58.8	14.43	51.5	11.09	44.1	8.19	36.8	5.72	29.4	3.70	22.1	2.11
31 °C	73.5	73.5	20.77	66.2	16.86	58.8	13.36	51.5	10.27	44.1	7.58	36.8	5.30	29.4	3.42	22.1	1.96
30 °C	73.5	73.5	20.01	66.2	16.24	58.8	12.87	51.5	9.89	44.1	7.30	36.8	5.10	29.4	3.30	22.1	1.89
29 °C	73.5	73.5	19.28	66.2	15.65	58.8	12.40	51.5	9.53	44.1	7.04	36.8	4.92	29.4	3.18	22.1	1.82
27 °C	73.5	73.5	17.93	66.2	14.56	58.8	11.54	51.5	8.87	44.1	6.55	36.8	4.58	29.4	2.96	22.1	1.69
25 °C	73.5	73.5	16.71	66.2	13.57	58.8	10.75	51.5	8.26	44.1	6.10	36.8	4.27	29.4	2.76	22.1	1.58
23 °C	73.5	73.5	15.93	66.2	12.93	58.8	10.25	51.5	7.88	44.1	5.82	36.8	4.07	29.4	2.63	22.1	1.51
21 °C	73.5	73.5	15.56	66.2	12.63	58.8	10.01	51.5	7.69	44.1	5.68	36.8	3.97	29.4	2.57	22.1	1.47
20 °C	73.5	73.5	15.39	66.2	12.50	58.8	9.91	51.5	7.61	44.1	5.62	36.8	3.93	29.4	2.54	22.1	1.46
19 °C	73.5	73.5	15.24	66.2	12.37	58.8	9.81	51.5	7.54	44.1	5.57	36.8	3.89	29.4	2.52	22.1	1.44
17 °C	73.5	73.5	14.97	66.2	12.15	58.8	9.63	51.5	7.40	44.1	5.47	36.8	3.82	29.4	2.47	22.1	1.42
15 °C	73.5	73.5	14.73	66.2	11.96	58.8	9.48	51.5	7.29	44.1	5.38	36.8	3.77	29.4	2.44	22.1	1.40

TC : Total Capacity PI : Power Input
 Indoor air temperature conditions : 27.0°C dry-bulb / 19.0°C wet bulb

Heating			Compressor + Outdoor Fan Power consumption (kW)															
			100% Capacity		90% Capacity		80% Capacity		70% Capacity		60% Capacity		50% Capacity		40% Capacity		30% Capacity	
			TC	PI	TC	PI	TC	PI	TC	PI	TC	PI	TC	PI	TC	PI	TC	PI
Outdoor Unit Dry-Bulb (°C)	Outdoor Unit Wet-Bulb (°C)	Outdoor Unit 100% Heating Capacity (kW)	(kW)	(kW)	(kW)	(kW)	(kW)	(kW)	(kW)	(kW)	(kW)	(kW)	(kW)	(kW)	(kW)	(kW)		
15.0	13.7	82.5	82.5	18.28	74.3	15.91	66.0	13.65	57.8	11.52	49.5	9.51	41.3	7.62	33.0	5.85	24.8	4.20
13.0	11.8	82.5	82.5	18.89	74.3	16.42	66.0	14.08	57.8	11.87	49.5	9.79	41.3	7.84	33.0	6.02	24.8	4.32
11.0	9.8	82.5	82.5	19.57	74.3	17.00	66.0	14.57	57.8	12.27	49.5	10.11	41.3	8.09	33.0	6.20	24.8	4.45
9.0	7.9	82.5	82.5	20.26	74.3	17.59	66.0	15.06	57.8	12.68	49.5	10.44	41.3	8.34	33.0	6.39	24.8	4.58
7.0	6.0	82.5	82.5	21.00	74.3	18.22	66.0	15.59	57.8	13.12	49.5	10.79	41.3	8.62	33.0	6.59	24.8	4.72
5.0	4.1	80.1	80.1	20.94	72.1	18.17	64.1	15.55	56.1	13.08	48.1	10.76	40.0	8.59	32.0	6.57	24.0	4.70
3.0	2.2	77.7	77.7	20.87	69.9	18.11	62.1	15.50	54.4	13.04	46.6	10.73	38.8	8.56	31.1	6.55	23.3	4.69
0.0	-0.7	74.0	74.0	20.78	66.6	18.03	59.2	15.43	51.8	12.98	44.4	10.68	37.0	8.52	29.6	6.52	22.2	4.67
-3.0	-3.7	70.2	70.2	20.67	63.2	17.94	56.2	15.35	49.1	12.91	42.1	10.62	35.1	8.48	28.1	6.49	21.1	4.64
-5.0	-5.6	67.8	67.8	20.61	61.0	17.88	54.2	15.30	47.4	12.87	40.7	10.59	33.9	8.46	27.1	6.47	20.3	4.63
-7.0	-7.6	65.2	65.2	20.54	58.7	17.83	52.2	15.26	45.7	12.83	39.1	10.56	32.6	8.43	26.1	6.45	19.6	4.61
-10	-10.5	61.6	61.6	20.45	55.4	17.74	49.2	15.18	43.1	12.77	36.9	10.51	30.8	8.39	24.6	6.42	18.5	4.59
-14.5	-15.0	55.8	55.8	20.29	50.3	17.61	44.7	15.07	39.1	12.68	33.5	10.43	27.9	8.33	22.3	6.37	16.8	4.56
-19.5	-20.0	49.5	49.5	20.13	44.6	17.46	39.6	14.95	34.7	12.57	29.7	10.34	24.8	8.26	19.8	6.32	14.9	4.52

TC : Total Capacity PI : Power Input
 Indoor air temperature conditions : 20.0°C dry-bulb

MMY-UP2811HT8P-E (28HP, 80.0 kW system)

Cooling		Compressor + Outdoor Fan Power consumption (kW)																	
		Outdoor Unit		100% Capacity		90% Capacity		80% Capacity		70% Capacity		60% Capacity		50% Capacity		40% Capacity		30% Capacity	
		Dry-Bulb (°C)	100% Cooling Capacity (kW)	TC (kW)	PI (kW)	TC (kW)	PI (kW)	TC (kW)	PI (kW)	TC (kW)	PI (kW)	TC (kW)	PI (kW)	TC (kW)	PI (kW)	TC (kW)	PI (kW)	TC (kW)	PI (kW)
46 °C	62.7	62.7	29.91	56.4	24.23	50.1	19.14	43.9	14.66	37.6	10.77	31.3	7.48	25.1	4.79	18.8	2.69		
43 °C	68.7	68.7	30.47	61.9	24.68	55.0	19.50	48.1	14.93	41.2	10.97	34.4	7.62	27.5	4.87	20.6	2.74		
41 °C	73.2	73.2	31.24	65.9	25.30	58.6	19.99	51.2	15.31	43.9	11.24	36.6	7.81	29.3	5.00	22.0	2.81		
39 °C	75.6	75.6	30.33	68.1	24.57	60.5	19.41	52.9	14.86	45.4	10.92	37.8	7.58	30.3	4.85	22.7	2.73		
37 °C	77.9	77.9	29.41	70.1	23.82	62.3	18.82	54.5	14.41	46.7	10.59	39.0	7.35	31.2	4.71	23.4	2.65		
35 °C	80.0	80.0	29.10	72.0	23.08	64.0	18.23	56.0	13.96	48.0	10.26	40.0	7.12	32.0	4.56	24.0	2.56		
32 °C	80.0	80.0	26.27	72.0	21.28	64.0	16.81	56.0	12.87	48.0	9.46	40.0	6.57	32.0	4.20	24.0	2.36		
31 °C	80.0	80.0	24.31	72.0	19.69	64.0	15.56	56.0	11.91	48.0	8.75	40.0	6.08	32.0	3.89	24.0	2.19		
30 °C	80.0	80.0	23.41	72.0	18.96	64.0	14.98	56.0	11.47	48.0	8.43	40.0	5.85	32.0	3.75	24.0	2.11		
29 °C	80.0	80.0	22.55	72.0	18.27	64.0	14.43	56.0	11.05	48.0	8.12	40.0	5.64	32.0	3.61	24.0	2.03		
27 °C	80.0	80.0	20.97	72.0	16.99	64.0	13.42	56.0	10.28	48.0	7.55	40.0	5.24	32.0	3.36	24.0	1.89		
25 °C	80.0	80.0	19.53	72.0	15.82	64.0	12.50	56.0	9.57	48.0	7.03	40.0	4.88	32.0	3.13	24.0	1.76		
23 °C	80.0	80.0	18.62	72.0	15.08	64.0	11.91	56.0	9.12	48.0	6.70	40.0	4.65	32.0	2.98	24.0	1.68		
21 °C	80.0	80.0	18.18	72.0	14.72	64.0	11.63	56.0	8.91	48.0	6.54	40.0	4.54	32.0	2.91	24.0	1.64		
20 °C	80.0	80.0	17.98	72.0	14.57	64.0	11.51	56.0	8.81	48.0	6.47	40.0	4.50	32.0	2.88	24.0	1.62		
19 °C	80.0	80.0	17.80	72.0	14.42	64.0	11.39	56.0	8.72	48.0	6.41	40.0	4.45	32.0	2.85	24.0	1.60		
17 °C	80.0	80.0	17.48	72.0	14.16	64.0	11.19	56.0	8.57	48.0	6.29	40.0	4.37	32.0	2.80	24.0	1.57		
15 °C	80.0	80.0	17.20	72.0	13.94	64.0	11.01	56.0	8.43	48.0	6.19	40.0	4.30	32.0	2.75	24.0	1.55		

TC : Total Capacity PI : Power Input
Indoor air temperature conditions : 27.0°C dry-bulb / 19.0°C wet bulb

Heating			Compressor + Outdoor Fan Power consumption (kW)																	
			Outdoor Unit		100% Capacity		90% Capacity		80% Capacity		70% Capacity		60% Capacity		50% Capacity		40% Capacity		30% Capacity	
			Dry-Bulb (°C)	Wet-Bulb (°C)	Heating Capacity (kW)	TC (kW)	PI (kW)	TC (kW)	PI (kW)	TC (kW)	PI (kW)	TC (kW)	PI (kW)	TC (kW)	PI (kW)	TC (kW)	PI (kW)	TC (kW)	PI (kW)	
15.0	13.7	90.0	90.0	21.01	81.0	18.19	72.0	15.53	63.0	13.03	54.0	10.69	45.0	8.51	36.0	6.49	27.0	4.63		
13.0	11.8	90.0	90.0	21.73	81.0	18.80	72.0	16.04	63.0	13.45	54.0	11.02	45.0	8.76	36.0	6.68	27.0	4.75		
11.0	9.8	90.0	90.0	22.54	81.0	19.49	72.0	16.61	63.0	13.92	54.0	11.40	45.0	9.05	36.0	6.89	27.0	4.90		
9.0	7.9	90.0	90.0	23.37	81.0	20.19	72.0	17.20	63.0	14.40	54.0	11.78	45.0	9.35	36.0	7.10	27.0	5.05		
7.0	6.0	90.0	90.0	24.26	81.0	20.95	72.0	17.83	63.0	14.91	54.0	12.19	45.0	9.66	36.0	7.33	27.0	5.20		
5.0	4.1	87.4	87.4	24.19	78.6	20.88	69.9	17.77	61.2	14.86	52.4	12.15	43.7	9.63	34.9	7.31	26.2	5.19		
3.0	2.2	84.7	84.7	24.11	76.3	20.82	67.8	17.72	59.3	14.82	50.8	12.11	42.4	9.60	33.9	7.29	25.4	5.17		
0.0	-0.7	80.7	80.7	24.00	72.7	20.72	64.6	17.64	56.5	14.75	48.4	12.06	40.4	9.56	32.3	7.26	24.2	5.15		
-3.0	-3.7	76.6	76.6	23.88	68.9	20.62	61.3	17.55	53.6	14.68	45.9	12.00	38.3	9.51	30.6	7.22	23.0	5.12		
-5.0	-5.6	73.9	73.9	23.81	66.5	20.56	59.2	17.50	51.8	14.63	44.4	11.96	37.0	9.48	29.6	7.20	22.2	5.11		
-7.0	-7.6	71.2	71.2	23.73	64.1	20.49	56.9	17.44	49.8	14.58	42.7	11.92	35.6	9.45	28.5	7.17	21.4	5.09		
-10	-10.5	67.2	67.2	23.62	60.4	20.39	53.7	17.36	47.0	14.51	40.3	11.86	33.6	9.41	26.9	7.14	20.1	5.07		
-14.5	-15.0	60.9	60.9	23.45	54.8	20.24	48.7	17.23	42.6	14.41	36.6	11.78	30.5	9.34	24.4	7.09	18.3	5.03		
-19.5	-20.0	54.0	54.0	23.25	48.6	20.07	43.2	17.09	37.8	14.29	32.4	11.68	27.0	9.26	21.6	7.03	16.2	4.99		

TC : Total Capacity PI : Power Input
Indoor air temperature conditions : 20.0°C dry-bulb

MMY-UP3011HT8P-E (30HP, 83.9 kW system)

Outdoor Unit Dry-Bulb (°C)		Outdoor Unit 100% Cooling Capacity (kW)	Compressor + Outdoor Fan Power consumption (kW)															
			100% Capacity		90% Capacity		80% Capacity		70% Capacity		60% Capacity		50% Capacity		40% Capacity		30% Capacity	
			TC	PI	TC	PI	TC	PI	TC	PI	TC	PI	TC	PI	TC	PI	TC	PI
		(kW)		(kW)		(kW)		(kW)		(kW)		(kW)		(kW)		(kW)		
46 °C		65.7	65.7	27.20	59.1	22.13	52.6	17.58	46.0	13.55	39.4	10.05	32.9	7.07	26.3	4.61	19.7	2.67
43 °C		72.1	72.1	27.67	64.9	22.51	57.7	17.88	50.5	13.78	43.2	10.22	36.0	7.19	28.8	4.68	21.6	2.72
41 °C		76.8	76.8	28.34	69.1	23.05	61.4	18.31	53.7	14.11	46.1	10.46	38.4	7.35	30.7	4.79	23.0	2.78
39 °C		79.3	79.3	27.52	71.4	22.38	63.5	17.78	55.5	13.70	47.6	10.16	39.7	7.14	31.7	4.65	23.8	2.69
37 °C		81.7	81.7	26.68	73.5	21.70	65.4	17.24	57.2	13.29	49.0	9.85	40.8	6.92	32.7	4.51	24.5	2.61
35 °C		83.9	83.9	26.24	75.5	21.03	67.1	16.70	58.7	12.87	50.3	9.54	42.0	6.71	33.6	4.37	25.2	2.53
32 °C		83.9	83.9	23.86	75.5	19.41	67.1	15.42	58.7	11.88	50.3	8.81	42.0	6.19	33.6	4.04	25.2	2.34
31 °C		83.9	83.9	22.09	75.5	17.97	67.1	14.28	58.7	11.01	50.3	8.16	42.0	5.74	33.6	3.74	25.2	2.17
30 °C		83.9	83.9	21.28	75.5	17.32	67.1	13.76	58.7	10.61	50.3	7.87	42.0	5.53	33.6	3.61	25.2	2.09
29 °C		83.9	83.9	20.51	75.5	16.69	67.1	13.26	58.7	10.22	50.3	7.58	42.0	5.33	33.6	3.48	25.2	2.02
27 °C		83.9	83.9	19.09	75.5	15.53	67.1	12.34	58.7	9.52	50.3	7.06	42.0	4.97	33.6	3.24	25.2	1.88
25 °C		83.9	83.9	17.79	75.5	14.48	67.1	11.50	58.7	8.87	50.3	6.58	42.0	4.63	33.6	3.02	25.2	1.76
23 °C		83.9	83.9	16.96	75.5	13.80	67.1	10.97	58.7	8.46	50.3	6.28	42.0	4.42	33.6	2.88	25.2	1.68
21 °C		83.9	83.9	16.57	75.5	13.49	67.1	10.72	58.7	8.27	50.3	6.14	42.0	4.32	33.6	2.82	25.2	1.64
20 °C		83.9	83.9	16.40	75.5	13.35	67.1	10.61	58.7	8.18	50.3	6.07	42.0	4.27	33.6	2.79	25.2	1.62
19 °C		83.9	83.9	16.24	75.5	13.22	67.1	10.50	58.7	8.10	50.3	6.01	42.0	4.23	33.6	2.76	25.2	1.61
17 °C		83.9	83.9	15.95	75.5	12.98	67.1	10.32	58.7	7.96	50.3	5.91	42.0	4.16	33.6	2.72	25.2	1.58
15 °C		83.9	83.9	15.70	75.5	12.78	67.1	10.16	58.7	7.84	50.3	5.82	42.0	4.10	33.6	2.68	25.2	1.56

TC : Total Capacity PI : Power Input
Indoor air temperature conditions : 27.0°C dry-bulb / 19.0°C wet bulb

Outdoor Unit Dry-Bulb (°C)		Outdoor Unit Wet-Bulb (°C)	Outdoor Unit 100% Heating Capacity (kW)	Compressor + Outdoor Fan Power consumption (kW)															
				100% Capacity		90% Capacity		80% Capacity		70% Capacity		60% Capacity		50% Capacity		40% Capacity		30% Capacity	
				TC	PI	TC	PI	TC	PI	TC	PI	TC	PI	TC	PI	TC	PI	TC	PI
		(kW)		(kW)		(kW)		(kW)		(kW)		(kW)		(kW)		(kW)			
15.0	13.7	93.5	93.5	20.67	84.2	18.05	74.8	15.55	65.5	13.18	56.1	10.92	46.8	8.79	37.4	6.79	28.1	4.91	
13.0	11.8	93.5	93.5	21.34	84.2	18.62	74.8	16.03	65.5	13.57	56.1	11.24	46.8	9.05	37.4	6.98	28.1	5.04	
11.0	9.8	93.5	93.5	22.08	84.2	19.26	74.8	16.57	65.5	14.02	56.1	11.60	46.8	9.33	37.4	7.19	28.1	5.19	
9.0	7.9	93.5	93.5	22.84	84.2	19.90	74.8	17.11	65.5	14.47	56.1	11.97	46.8	9.61	37.4	7.40	28.1	5.34	
7.0	6.0	93.5	93.5	23.65	84.2	20.60	74.8	17.70	65.5	14.95	56.1	12.36	46.8	9.92	37.4	7.63	28.1	5.49	
5.0	4.1	90.8	90.8	23.58	81.7	20.54	72.6	17.65	63.5	14.91	54.5	12.32	45.4	9.89	36.3	7.61	27.2	5.48	
3.0	2.2	88.0	88.0	23.51	79.2	20.47	70.4	17.59	61.6	14.86	52.8	12.29	44.0	9.86	35.2	7.58	26.4	5.46	
0.0	-0.7	83.9	83.9	23.40	75.5	20.38	67.1	17.51	58.7	14.79	50.3	12.23	41.9	9.81	33.5	7.55	25.2	5.44	
-3.0	-3.7	79.5	79.5	23.28	71.6	20.28	63.6	17.43	55.7	14.72	47.7	12.17	39.8	9.77	31.8	7.51	23.9	5.41	
-5.0	-5.6	76.8	76.8	23.21	69.1	20.22	61.5	17.37	53.8	14.68	46.1	12.13	38.4	9.73	30.7	7.49	23.0	5.39	
-7.0	-7.6	73.9	73.9	23.14	66.5	20.15	59.1	17.32	51.8	14.63	44.4	12.09	37.0	9.70	29.6	7.46	22.2	5.37	
-10	-10.5	69.8	69.8	23.03	62.8	20.06	55.8	17.23	48.8	14.56	41.9	12.03	34.9	9.66	27.9	7.43	20.9	5.35	
-14.5	-15.0	63.3	63.3	22.86	57.0	19.91	50.6	17.11	44.3	14.45	38.0	11.95	31.6	9.59	25.3	7.37	19.0	5.31	
-19.5	-20.0	56.1	56.1	22.67	50.5	19.74	44.9	16.96	39.3	14.33	33.7	11.85	28.1	9.51	22.4	7.31	16.8	5.27	

TC : Total Capacity PI : Power Input
Indoor air temperature conditions : 20.0°C dry-bulb

MMY-UP3211HT8P-E (32HP, 89.5 kW system)

Cooling		Compressor + Outdoor Fan Power consumption (kW)																	
		Outdoor Unit Dry-Bulb (°C)	Outdoor Unit 100% Cooling Capacity (kW)	100% Capacity		90% Capacity		80% Capacity		70% Capacity		60% Capacity		50% Capacity		40% Capacity		30% Capacity	
				TC	PI	TC	PI	TC	PI	TC	PI	TC	PI	TC	PI	TC	PI	TC	PI
				(kW)	(kW)	(kW)	(kW)	(kW)	(kW)	(kW)	(kW)	(kW)	(kW)	(kW)	(kW)	(kW)	(kW)	(kW)	(kW)
46 °C	70.1	70.1	29.13	63.1	23.65	56.1	18.74	49.1	14.41	42.1	10.64	35.1	7.45	28.0	4.82	21.0	2.77		
43 °C	76.9	76.9	29.65	69.2	24.07	61.5	19.08	53.8	14.66	46.1	10.83	38.4	7.58	30.8	4.91	23.1	2.82		
41 °C	81.9	81.9	30.38	73.7	24.66	65.5	19.54	57.3	15.02	49.1	11.09	40.9	7.76	32.8	5.02	24.6	2.88		
39 °C	84.6	84.6	29.50	76.2	23.95	67.7	18.98	59.2	14.58	50.8	10.77	42.3	7.53	33.9	4.87	25.4	2.80		
37 °C	87.2	87.2	28.61	78.4	23.22	69.7	18.40	61.0	14.14	52.3	10.44	43.6	7.30	34.9	4.73	26.1	2.71		
35 °C	89.5	89.5	28.35	80.6	22.50	71.6	17.82	62.7	13.70	53.7	10.11	44.8	7.07	35.8	4.58	26.9	2.63		
32 °C	89.5	89.5	25.57	80.6	20.76	71.6	16.45	62.7	12.64	53.7	9.34	44.8	6.53	35.8	4.23	26.9	2.43		
31 °C	89.5	89.5	23.67	80.6	19.22	71.6	15.23	62.7	11.70	53.7	8.64	44.8	6.05	35.8	3.92	26.9	2.25		
30 °C	89.5	89.5	22.79	80.6	18.51	71.6	14.67	62.7	11.27	53.7	8.33	44.8	5.83	35.8	3.77	26.9	2.17		
29 °C	89.5	89.5	21.97	80.6	17.84	71.6	14.14	62.7	10.87	53.7	8.03	44.8	5.62	35.8	3.64	26.9	2.09		
27 °C	89.5	89.5	20.43	80.6	16.59	71.6	13.15	62.7	10.11	53.7	7.47	44.8	5.23	35.8	3.39	26.9	1.95		
25 °C	89.5	89.5	19.04	80.6	15.46	71.6	12.25	62.7	9.42	53.7	6.96	44.8	4.87	35.8	3.16	26.9	1.82		
23 °C	89.5	89.5	18.15	80.6	14.74	71.6	11.68	62.7	8.98	53.7	6.64	44.8	4.65	35.8	3.01	26.9	1.73		
21 °C	89.5	89.5	17.73	80.6	14.40	71.6	11.41	62.7	8.77	53.7	6.48	44.8	4.54	35.8	2.94	26.9	1.70		
20 °C	89.5	89.5	17.54	80.6	14.24	71.6	11.29	62.7	8.68	53.7	6.42	44.8	4.49	35.8	2.91	26.9	1.68		
19 °C	89.5	89.5	17.37	80.6	14.10	71.6	11.18	62.7	8.60	53.7	6.35	44.8	4.45	35.8	2.89	26.9	1.66		
17 °C	89.5	89.5	17.05	80.6	13.85	71.6	10.98	62.7	8.44	53.7	6.24	44.8	4.37	35.8	2.83	26.9	1.63		
15 °C	89.5	89.5	16.79	80.6	13.63	71.6	10.81	62.7	8.31	53.7	6.14	44.8	4.30	35.8	2.79	26.9	1.61		

TC : Total Capacity PI : Power Input
 Indoor air temperature conditions : 27.0°C dry-bulb / 19.0°C wet bulb

Heating			Compressor + Outdoor Fan Power consumption (kW)																		
			Outdoor Unit Dry-Bulb (°C)	Outdoor Unit Wet-Bulb (°C)	Outdoor Unit 100% Heating Capacity (kW)	100% Capacity		90% Capacity		80% Capacity		70% Capacity		60% Capacity		50% Capacity		40% Capacity		30% Capacity	
						TC	PI	TC	PI	TC	PI	TC	PI	TC	PI	TC	PI	TC	PI	TC	PI
						(kW)	(kW)	(kW)	(kW)	(kW)	(kW)	(kW)	(kW)	(kW)	(kW)	(kW)	(kW)	(kW)	(kW)	(kW)	(kW)
15.0	13.7	100.5	100.5	23.17	90.5	20.19	80.4	17.37	70.4	14.70	60.3	12.18	50.3	9.82	40.2	7.61	30.2	5.56			
13.0	11.8	100.5	100.5	23.92	90.5	20.83	80.4	17.91	70.4	15.14	60.3	12.54	50.3	10.10	40.2	7.82	30.2	5.70			
11.0	9.8	100.5	100.5	24.77	90.5	21.56	80.4	18.51	70.4	15.64	60.3	12.94	50.3	10.41	40.2	8.05	30.2	5.86			
9.0	7.9	100.5	100.5	25.64	90.5	22.30	80.4	19.13	70.4	16.15	60.3	13.35	50.3	10.72	40.2	8.28	30.2	6.02			
7.0	6.0	100.5	100.5	26.57	90.5	23.09	80.4	19.80	70.4	16.69	60.3	13.78	50.3	11.06	40.2	8.53	30.2	6.19			
5.0	4.1	97.6	97.6	26.49	87.8	23.02	78.1	19.74	68.3	16.64	58.5	13.74	48.8	11.03	39.0	8.51	29.3	6.17			
3.0	2.2	94.6	94.6	26.41	85.2	22.95	75.7	19.68	66.2	16.59	56.8	13.70	47.3	11.00	37.9	8.48	28.4	6.16			
0.0	-0.7	90.1	90.1	26.29	81.1	22.84	72.1	19.58	63.1	16.52	54.1	13.64	45.1	10.94	36.1	8.44	27.0	6.13			
-3.0	-3.7	85.5	85.5	26.16	77.0	22.73	68.4	19.49	59.9	16.44	51.3	13.57	42.8	10.89	34.2	8.40	25.7	6.10			
-5.0	-5.6	82.6	82.6	26.08	74.3	22.66	66.1	19.43	57.8	16.38	49.5	13.53	41.3	10.86	33.0	8.37	24.8	6.08			
-7.0	-7.6	79.5	79.5	25.99	71.5	22.59	63.6	19.37	55.6	16.33	47.7	13.48	39.7	10.82	31.8	8.35	23.8	6.06			
-10	-10.5	75.0	75.0	25.87	67.5	22.48	60.0	19.27	52.5	16.25	45.0	13.42	37.5	10.77	30.0	8.31	22.5	6.03			
-14.5	-15.0	68.0	68.0	25.68	61.2	22.31	54.4	19.13	47.6	16.13	40.8	13.32	34.0	10.69	27.2	8.25	20.4	5.98			
-19.5	-20.0	60.3	60.3	25.47	54.3	22.13	48.2	18.97	42.2	16.00	36.2	13.21	30.2	10.60	24.1	8.18	18.1	5.94			

TC : Total Capacity PI : Power Input
 Indoor air temperature conditions : 20.0°C dry-bulb



MMY-UP3411HT8P-E (34HP, 96.0 kW system)

Cooling		Compressor + Outdoor Fan Power consumption (kW)																	
		Outdoor Unit Dry-Bulb (°C)	Outdoor Unit 100% Cooling Capacity (kW)	100% Capacity		90% Capacity		80% Capacity		70% Capacity		60% Capacity		50% Capacity		40% Capacity		30% Capacity	
				TC (kW)	PI (kW)	TC (kW)	PI (kW)	TC (kW)	PI (kW)	TC (kW)	PI (kW)	TC (kW)	PI (kW)	TC (kW)	PI (kW)	TC (kW)	PI (kW)	TC (kW)	PI (kW)
46 °C	75.2	75.2	33.47	67.7	27.12	60.2	21.44	52.6	16.43	45.1	12.08	37.6	8.40	30.1	5.39	22.6	3.05		
43 °C	82.5	82.5	34.09	74.2	27.63	66.0	21.84	57.7	16.73	49.5	12.30	41.2	8.56	33.0	5.49	24.7	3.11		
41 °C	87.8	87.8	34.95	79.1	28.32	70.3	22.38	61.5	17.15	52.7	12.61	43.9	8.77	35.1	5.63	26.4	3.18		
39 °C	90.8	90.8	33.94	81.7	27.50	72.6	21.73	63.5	16.65	54.5	12.24	45.4	8.51	36.3	5.46	27.2	3.09		
37 °C	93.5	93.5	32.91	84.1	26.66	74.8	21.08	65.4	16.15	56.1	11.87	46.7	8.26	37.4	5.30	28.0	3.00		
35 °C	96.0	96.0	32.56	86.4	25.83	76.8	20.42	67.2	15.64	57.6	11.50	48.0	8.00	38.4	5.13	28.8	2.90		
32 °C	96.0	96.0	29.40	86.4	23.82	76.8	18.83	67.2	14.43	57.6	10.61	48.0	7.38	38.4	4.74	28.8	2.68		
31 °C	96.0	96.0	27.20	86.4	22.04	76.8	17.42	67.2	13.35	57.6	9.82	48.0	6.83	38.4	4.38	28.8	2.48		
30 °C	96.0	96.0	26.20	86.4	21.23	76.8	16.78	67.2	12.85	57.6	9.45	48.0	6.58	38.4	4.22	28.8	2.39		
29 °C	96.0	96.0	25.24	86.4	20.45	76.8	16.17	67.2	12.39	57.6	9.11	48.0	6.34	38.4	4.07	28.8	2.30		
27 °C	96.0	96.0	23.47	86.4	19.02	76.8	15.03	67.2	11.52	57.6	8.47	48.0	5.89	38.4	3.78	28.8	2.14		
25 °C	96.0	96.0	21.86	86.4	17.71	76.8	14.00	67.2	10.73	57.6	7.89	48.0	5.49	38.4	3.52	28.8	2.00		
23 °C	96.0	96.0	20.84	86.4	16.88	76.8	13.35	67.2	10.23	57.6	7.52	48.0	5.23	38.4	3.36	28.8	1.90		
21 °C	96.0	96.0	20.35	86.4	16.49	76.8	13.03	67.2	9.99	57.6	7.35	48.0	5.11	38.4	3.28	28.8	1.86		
20 °C	96.0	96.0	20.13	86.4	16.31	76.8	12.89	67.2	9.88	57.6	7.27	48.0	5.06	38.4	3.25	28.8	1.84		
19 °C	96.0	96.0	19.93	86.4	16.15	76.8	12.77	67.2	9.78	57.6	7.19	48.0	5.01	38.4	3.21	28.8	1.82		
17 °C	96.0	96.0	19.57	86.4	15.86	76.8	12.53	67.2	9.60	57.6	7.06	48.0	4.92	38.4	3.16	28.8	1.79		
15 °C	96.0	96.0	19.26	86.4	15.61	76.8	12.34	67.2	9.45	57.6	6.95	48.0	4.84	38.4	3.11	28.8	1.76		

TC : Total Capacity PI : Power Input
 Indoor air temperature conditions : 27.0°C dry-bulb / 19.0°C wet bulb

Heating		Compressor + Outdoor Fan Power consumption (kW)																		
		Outdoor Unit Dry-Bulb (°C)	Outdoor Unit Wet-Bulb (°C)	Outdoor Unit 100% Heating Capacity (kW)	100% Capacity		90% Capacity		80% Capacity		70% Capacity		60% Capacity		50% Capacity		40% Capacity		30% Capacity	
					TC (kW)	PI (kW)	TC (kW)	PI (kW)	TC (kW)	PI (kW)	TC (kW)	PI (kW)	TC (kW)	PI (kW)	TC (kW)	PI (kW)	TC (kW)	PI (kW)	TC (kW)	PI (kW)
15.0	13.7	108.0	108.0	25.90	97.2	22.47	86.4	19.25	75.6	16.21	64.8	13.36	54.0	10.71	43.2	8.25	32.4	5.98		
13.0	11.8	108.0	108.0	26.77	97.2	23.21	86.4	19.86	75.6	16.71	64.8	13.77	54.0	11.02	43.2	8.48	32.4	6.13		
11.0	9.8	108.0	108.0	27.75	97.2	24.05	86.4	20.56	75.6	17.28	64.8	14.22	54.0	11.37	43.2	8.73	32.4	6.31		
9.0	7.9	108.0	108.0	28.75	97.2	24.90	86.4	21.27	75.6	17.86	64.8	14.68	54.0	11.73	43.2	9.00	32.4	6.49		
7.0	6.0	108.0	108.0	29.83	97.2	25.81	86.4	22.03	75.6	18.49	64.8	15.18	54.0	12.11	43.2	9.28	32.4	6.68		
5.0	4.1	104.8	104.8	29.74	94.4	25.73	83.9	21.96	73.4	18.43	62.9	15.13	52.4	12.07	41.9	9.25	31.5	6.66		
3.0	2.2	101.7	101.7	29.65	91.5	25.65	81.3	21.90	71.2	18.37	61.0	15.09	50.8	12.03	40.7	9.22	30.5	6.64		
0.0	-0.7	96.9	96.9	29.51	87.2	25.53	77.5	21.79	67.8	18.29	58.1	15.02	48.4	11.98	38.7	9.18	29.1	6.61		
-3.0	-3.7	91.9	91.9	29.37	82.7	25.41	73.5	21.69	64.3	18.20	55.1	14.94	45.9	11.92	36.8	9.13	27.6	6.58		
-5.0	-5.6	88.7	88.7	29.28	79.9	25.33	71.0	21.62	62.1	18.14	53.2	14.90	44.4	11.88	35.5	9.10	26.6	6.56		
-7.0	-7.6	85.4	85.4	29.18	76.9	25.25	68.3	21.55	59.8	18.08	51.2	14.85	42.7	11.84	34.2	9.07	25.6	6.53		
-10	-10.5	80.6	80.6	29.04	72.5	25.13	64.5	21.45	56.4	18.00	48.4	14.78	40.3	11.79	32.2	9.03	24.2	6.50		
-14.5	-15.0	73.1	73.1	28.83	65.8	24.94	58.5	21.29	51.2	17.86	43.9	14.67	36.6	11.70	29.2	8.96	21.9	6.46		
-19.5	-20.0	64.8	64.8	28.59	58.3	24.74	51.8	21.11	45.4	17.72	38.9	14.55	32.4	11.60	25.9	8.89	19.4	6.40		

TC : Total Capacity PI : Power Input
 Indoor air temperature conditions : 20.0°C dry-bulb

MMY-UP3611HT8P-E(36HP, 100.5 kW system)

Outdoor Unit Dry-Bulb (°C)		Outdoor Unit 100% Cooling Capacity (kW)	Compressor + Outdoor Fan Power consumption (kW)															
			100% Capacity		90% Capacity		80% Capacity		70% Capacity		60% Capacity		50% Capacity		40% Capacity		30% Capacity	
			TC	PI	TC	PI	TC	PI	TC	PI	TC	PI	TC	PI	TC	PI	TC	PI
			(kW)	(kW)	(kW)	(kW)	(kW)	(kW)	(kW)	(kW)	(kW)	(kW)	(kW)	(kW)	(kW)	(kW)	(kW)	(kW)
46 °C		78.7	35.48	70.8	28.78	63.0	22.79	55.1	17.49	47.2	12.90	39.4	9.00	31.5	5.80	23.6	3.30	
43 °C		86.3	36.12	77.7	29.31	69.1	23.20	60.4	17.81	51.8	13.13	43.2	9.16	34.5	5.90	25.9	3.36	
41 °C		92.0	37.02	82.8	30.03	73.6	23.78	64.4	18.25	55.2	13.45	46.0	9.38	36.8	6.05	27.6	3.44	
39 °C		95.0	35.94	85.5	29.16	76.0	23.08	66.5	17.72	57.0	13.06	47.5	9.11	38.0	5.87	28.5	3.34	
37 °C		97.9	34.86	88.1	28.28	78.3	22.39	68.5	17.18	58.7	12.66	48.9	8.84	39.1	5.69	29.4	3.24	
35 °C		100.5	34.53	90.5	27.39	80.4	21.69	70.4	16.64	60.3	12.27	50.3	8.56	40.2	5.52	30.2	3.14	
32 °C		100.5	31.15	90.5	25.27	80.4	20.01	70.4	15.36	60.3	11.32	50.3	7.90	40.2	5.09	30.2	2.90	
31 °C		100.5	28.83	90.5	23.39	80.4	18.52	70.4	14.21	60.3	10.48	50.3	7.31	40.2	4.71	30.2	2.68	
30 °C		100.5	27.76	90.5	22.53	80.4	17.83	70.4	13.69	60.3	10.09	50.3	7.04	40.2	4.54	30.2	2.58	
29 °C		100.5	26.76	90.5	21.71	80.4	17.19	70.4	13.19	60.3	9.73	50.3	6.79	40.2	4.38	30.2	2.49	
27 °C		100.5	24.88	90.5	20.19	80.4	15.99	70.4	12.27	60.3	9.05	50.3	6.31	40.2	4.07	30.2	2.32	
25 °C		100.5	23.18	90.5	18.81	80.4	14.89	70.4	11.43	60.3	8.43	50.3	5.88	40.2	3.79	30.2	2.16	
23 °C		100.5	22.10	90.5	17.93	80.4	14.20	70.4	10.90	60.3	8.04	50.3	5.61	40.2	3.62	30.2	2.06	
21 °C		100.5	21.58	90.5	17.51	80.4	13.87	70.4	10.65	60.3	7.85	50.3	5.48	40.2	3.53	30.2	2.01	
20 °C		100.5	21.35	90.5	17.33	80.4	13.72	70.4	10.53	60.3	7.77	50.3	5.42	40.2	3.50	30.2	1.99	
19 °C		100.5	21.14	90.5	17.15	80.4	13.58	70.4	10.43	60.3	7.69	50.3	5.37	40.2	3.46	30.2	1.97	
17 °C		100.5	20.76	90.5	16.85	80.4	13.34	70.4	10.24	60.3	7.55	50.3	5.27	40.2	3.40	30.2	1.94	
15 °C		100.5	20.44	90.5	16.58	80.4	13.13	70.4	10.08	60.3	7.44	50.3	5.19	40.2	3.35	30.2	1.91	

TC : Total Capacity PI : Power Input
Indoor air temperature conditions : 27.0°C dry-bulb / 19.0°C wet bulb

Outdoor Unit Dry-Bulb / Wet-Bulb (°C) / (°C)		Outdoor Unit 100% Heating Capacity (kW)	Compressor + Outdoor Fan Power consumption (kW)															
			100% Capacity		90% Capacity		80% Capacity		70% Capacity		60% Capacity		50% Capacity		40% Capacity		30% Capacity	
			TC	PI	TC	PI	TC	PI	TC	PI	TC	PI	TC	PI	TC	PI	TC	PI
			(kW)	(kW)	(kW)	(kW)	(kW)	(kW)	(kW)	(kW)	(kW)	(kW)	(kW)	(kW)	(kW)	(kW)	(kW)	(kW)
15.0	13.7	107.5	26.30	96.8	23.27	86.0	20.33	75.3	17.48	64.5	14.71	53.8	12.04	43.0	9.45	32.3	6.96	
13.0	11.8	107.5	27.05	96.8	23.92	86.0	20.89	75.3	17.95	64.5	15.11	53.8	12.36	43.0	9.70	32.3	7.13	
11.0	9.8	107.5	27.88	96.8	24.65	86.0	21.52	75.3	18.48	64.5	15.55	53.8	12.71	43.0	9.97	32.3	7.33	
9.0	7.9	107.5	28.73	96.8	25.39	86.0	22.15	75.3	19.02	64.5	15.99	53.8	13.07	43.0	10.24	32.3	7.53	
7.0	6.0	107.5	29.64	96.8	26.18	86.0	22.83	75.3	19.59	64.5	16.47	53.8	13.45	43.0	10.54	32.3	7.74	
5.0	4.1	104.4	29.55	93.9	26.10	83.5	22.76	73.1	19.53	62.6	16.42	52.2	13.41	41.7	10.51	31.3	7.71	
3.0	2.2	101.2	29.46	91.1	26.02	81.0	22.69	70.9	19.48	60.7	16.37	50.6	13.36	40.5	10.47	30.4	7.69	
0.0	-0.7	96.4	29.32	86.8	25.90	77.1	22.59	67.5	19.38	57.9	16.29	48.2	13.30	38.6	10.42	28.9	7.66	
-3.0	-3.7	91.5	29.18	82.3	25.78	73.2	22.48	64.0	19.29	54.9	16.21	45.7	13.24	36.6	10.37	27.4	7.62	
-5.0	-5.6	88.3	29.09	79.5	25.70	70.7	22.41	61.8	19.23	53.0	16.16	44.2	13.20	35.3	10.34	26.5	7.59	
-7.0	-7.6	85.0	29.00	76.5	25.61	68.0	22.34	59.5	19.17	51.0	16.11	42.5	13.15	34.0	10.31	25.5	7.57	
-10	-10.5	80.2	28.86	72.2	25.49	64.2	22.23	56.1	19.08	48.1	16.03	40.1	13.09	32.1	10.26	24.1	7.53	
-14.5	-15.0	72.8	28.64	65.5	25.30	58.2	22.07	50.9	18.94	43.7	15.91	36.4	12.99	29.1	10.18	21.8	7.48	
-19.5	-20.0	64.5	28.41	58.1	25.09	51.6	21.88	45.2	18.78	38.7	15.78	32.3	12.89	25.8	10.10	19.4	7.42	

TC : Total Capacity PI : Power Input
Indoor air temperature conditions : 20.0°C dry-bulb

MMY-UP3811HT8P-E (38HP, 107.0 kW system)

Outdoor Unit Dry-Bulb (°C)		Outdoor Unit 100% Cooling Capacity (kW)	Compressor + Outdoor Fan Power consumption (kW)															
			100% Capacity		90% Capacity		80% Capacity		70% Capacity		60% Capacity		50% Capacity		40% Capacity		30% Capacity	
			TC	PI	TC	PI	TC	PI	TC	PI	TC	PI	TC	PI	TC	PI	TC	PI
46 °C	83.8	83.8	39.82	75.4	32.26	67.0	25.49	58.7	19.51	50.3	14.34	41.9	9.96	33.5	6.37	25.1	3.58	
43 °C	91.9	91.9	40.57	82.7	32.86	73.5	25.96	64.3	19.88	55.2	14.60	46.0	10.14	36.8	6.49	27.6	3.65	
41 °C	97.9	97.9	41.59	88.1	33.69	78.3	26.62	68.5	20.38	58.7	14.97	49.0	10.40	39.2	6.65	29.4	3.74	
39 °C	101.2	101.2	40.38	91.1	32.71	80.9	25.84	70.8	19.79	60.7	14.54	50.6	10.10	40.5	6.46	30.4	3.63	
37 °C	104.2	104.2	39.16	93.8	31.72	83.4	25.06	72.9	19.19	62.5	14.10	52.1	9.79	41.7	6.27	31.3	3.52	
35 °C	107.0	107.0	38.74	96.3	30.73	85.6	24.28	74.9	18.59	64.2	13.66	53.5	9.48	42.8	6.07	32.1	3.41	
32 °C	107.0	107.0	34.98	96.3	28.33	85.6	22.39	74.9	17.14	64.2	12.59	53.5	8.75	42.8	5.60	32.1	3.15	
31 °C	107.0	107.0	32.37	96.3	26.22	85.6	20.71	74.9	15.86	64.2	11.65	53.5	8.09	42.8	5.18	32.1	2.91	
30 °C	107.0	107.0	31.17	96.3	25.24	85.6	19.95	74.9	15.27	64.2	11.22	53.5	7.79	42.8	4.99	32.1	2.80	
29 °C	107.0	107.0	30.03	96.3	24.32	85.6	19.22	74.9	14.71	64.2	10.81	53.5	7.51	42.8	4.80	32.1	2.70	
27 °C	107.0	107.0	27.92	96.3	22.62	85.6	17.87	74.9	13.68	64.2	10.05	53.5	6.98	42.8	4.47	32.1	2.51	
25 °C	107.0	107.0	26.01	96.3	21.07	85.6	16.64	74.9	12.74	64.2	9.36	53.5	6.50	42.8	4.16	32.1	2.34	
23 °C	107.0	107.0	24.79	96.3	20.08	85.6	15.86	74.9	12.14	64.2	8.92	53.5	6.20	42.8	3.97	32.1	2.23	
21 °C	107.0	107.0	24.20	96.3	19.60	85.6	15.49	74.9	11.86	64.2	8.71	53.5	6.05	42.8	3.87	32.1	2.18	
20 °C	107.0	107.0	23.94	96.3	19.39	85.6	15.32	74.9	11.73	64.2	8.62	53.5	5.99	42.8	3.83	32.1	2.15	
19 °C	107.0	107.0	23.70	96.3	19.20	85.6	15.17	74.9	11.61	64.2	8.53	53.5	5.93	42.8	3.79	32.1	2.13	
17 °C	107.0	107.0	23.27	96.3	18.85	85.6	14.90	74.9	11.40	64.2	8.38	53.5	5.82	42.8	3.72	32.1	2.09	
15 °C	107.0	107.0	22.91	96.3	18.55	85.6	14.66	74.9	11.22	64.2	8.25	53.5	5.73	42.8	3.67	32.1	2.06	

TC : Total Capacity PI : Power Input
Indoor air temperature conditions : 27.0°C dry-bulb / 19.0°C wet bulb

Outdoor Unit Dry-Bulb / Wet-Bulb (°C) / (°C)		Outdoor Unit 100% Heating Capacity (kW)	Compressor + Outdoor Fan Power consumption (kW)															
			100% Capacity		90% Capacity		80% Capacity		70% Capacity		60% Capacity		50% Capacity		40% Capacity		30% Capacity	
			TC	PI	TC	PI	TC	PI	TC	PI	TC	PI	TC	PI	TC	PI	TC	PI
15.0	13.7	115.0	115.0	29.03	103.5	25.55	92.0	22.21	80.5	18.99	69.0	15.89	57.5	12.93	46.0	10.09	34.5	7.38
13.0	11.8	115.0	115.0	29.89	103.5	26.30	92.0	22.85	80.5	19.52	69.0	16.34	57.5	13.28	46.0	10.36	34.5	7.57
11.0	9.8	115.0	115.0	30.86	103.5	27.14	92.0	23.56	80.5	20.13	69.0	16.83	57.5	13.67	46.0	10.66	34.5	7.78
9.0	7.9	115.0	115.0	31.85	103.5	27.99	92.0	24.29	80.5	20.73	69.0	17.33	57.5	14.07	46.0	10.96	34.5	8.00
7.0	6.0	115.0	115.0	32.90	103.5	28.91	92.0	25.07	80.5	21.39	69.0	17.86	57.5	14.49	46.0	11.28	34.5	8.23
5.0	4.1	111.6	111.6	32.80	100.5	28.82	89.3	24.99	78.1	21.32	67.0	17.81	55.8	14.45	44.7	11.25	33.5	8.20
3.0	2.2	108.3	108.3	32.70	97.5	28.73	86.6	24.91	75.8	21.26	65.0	17.75	54.1	14.40	43.3	11.21	32.5	8.18
0.0	-0.7	103.1	103.1	32.55	92.8	28.60	82.5	24.80	72.2	21.16	61.9	17.67	51.6	14.34	41.3	11.16	30.9	8.14
-3.0	-3.7	97.8	97.8	32.39	88.1	28.46	78.3	24.68	68.5	21.05	58.7	17.58	48.9	14.27	39.1	11.11	29.4	8.10
-5.0	-5.6	94.5	94.5	32.29	85.0	28.37	75.6	24.60	66.1	20.99	56.7	17.53	47.2	14.22	37.8	11.07	28.3	8.07
-7.0	-7.6	90.9	90.9	32.18	81.8	28.28	72.8	24.52	63.7	20.92	54.6	17.47	45.5	14.18	36.4	11.03	27.3	8.05
-10	-10.5	85.8	85.8	32.03	77.2	28.14	68.6	24.41	60.1	20.82	51.5	17.39	42.9	14.11	34.3	10.98	25.7	8.01
-14.5	-15.0	77.8	77.8	31.79	70.1	27.93	62.3	24.22	54.5	20.67	46.7	17.26	38.9	14.01	31.1	10.90	23.4	7.95
-19.5	-20.0	69.0	69.0	31.53	62.1	27.70	55.2	24.02	48.3	20.50	41.4	17.12	34.5	13.89	27.6	10.81	20.7	7.88

TC : Total Capacity PI : Power Input
Indoor air temperature conditions : 20.0°C dry-bulb

MMY-UP4011HT8P-E (40HP, 112.0 kW system)

Cooling		Compressor + Outdoor Fan Power consumption (kW)															
		100% Capacity		90% Capacity		80% Capacity		70% Capacity		60% Capacity		50% Capacity		40% Capacity		30% Capacity	
		TC	PI	TC	PI	TC	PI	TC	PI	TC	PI	TC	PI	TC	PI	TC	PI
Outdoor Unit Dry-Bulb (°C)	Outdoor Unit 100% Cooling Capacity (kW)	(kW)	(kW)	(kW)	(kW)	(kW)	(kW)	(kW)	(kW)	(kW)	(kW)	(kW)	(kW)	(kW)	(kW)	(kW)	
46 °C	87.7	87.7	37.04	79.0	30.02	70.2	23.74	61.4	18.19	52.6	13.39	43.9	9.33	35.1	6.00	26.3	3.42
43 °C	96.2	96.2	37.72	86.6	30.57	77.0	24.17	67.4	18.53	57.7	13.64	48.1	9.50	38.5	6.11	28.9	3.47
41 °C	102.5	102.5	38.67	92.2	31.34	82.0	24.78	71.7	18.99	61.5	13.97	51.2	9.73	41.0	6.26	30.7	3.56
39 °C	105.9	105.9	37.54	95.3	30.43	84.7	24.06	74.1	18.44	63.5	13.57	52.9	9.45	42.4	6.08	31.8	3.45
37 °C	109.1	109.1	36.41	98.2	29.51	87.2	23.33	76.3	17.88	65.4	13.16	54.5	9.16	43.6	5.89	32.7	3.35
35 °C	112.0	112.0	36.02	100.8	28.58	89.6	22.60	78.4	17.32	67.2	12.75	56.0	8.88	44.8	5.71	33.6	3.24
32 °C	112.0	112.0	32.53	100.8	26.36	89.6	20.85	78.4	15.98	67.2	11.76	56.0	8.19	44.8	5.27	33.6	3.00
31 °C	112.0	112.0	30.10	100.8	24.39	89.6	19.29	78.4	14.79	67.2	10.88	56.0	7.58	44.8	4.88	33.6	2.77
30 °C	112.0	112.0	28.99	100.8	23.49	89.6	18.58	78.4	14.24	67.2	10.48	56.0	7.30	44.8	4.70	33.6	2.67
29 °C	112.0	112.0	27.93	100.8	22.64	89.6	17.90	78.4	13.72	67.2	10.10	56.0	7.03	44.8	4.53	33.6	2.58
27 °C	112.0	112.0	25.97	100.8	21.05	89.6	16.65	78.4	12.76	67.2	9.39	56.0	6.54	44.8	4.21	33.6	2.40
25 °C	112.0	112.0	24.19	100.8	19.61	89.6	15.51	78.4	11.89	67.2	8.75	56.0	6.10	44.8	3.92	33.6	2.24
23 °C	112.0	112.0	23.06	100.8	18.69	89.6	14.78	78.4	11.33	67.2	8.34	56.0	5.81	44.8	3.74	33.6	2.13
21 °C	112.0	112.0	22.52	100.8	18.25	89.6	14.43	78.4	11.07	67.2	8.15	56.0	5.68	44.8	3.66	33.6	2.08
20 °C	112.0	112.0	22.28	100.8	18.06	89.6	14.28	78.4	10.95	67.2	8.06	56.0	5.62	44.8	3.62	33.6	2.06
19 °C	112.0	112.0	22.05	100.8	17.88	89.6	14.14	78.4	10.84	67.2	7.98	56.0	5.56	44.8	3.58	33.6	2.04
17 °C	112.0	112.0	21.66	100.8	17.55	89.6	13.88	78.4	10.64	67.2	7.84	56.0	5.46	44.8	3.52	33.6	2.01
15 °C	112.0	112.0	21.31	100.8	17.28	89.6	13.66	78.4	10.48	67.2	7.71	56.0	5.38	44.8	3.46	33.6	1.98

TC : Total Capacity PI : Power Input
 Indoor air temperature conditions : 27.0°C dry-bulb / 19.0°C wet bulb

Heating			Compressor + Outdoor Fan Power consumption (kW)															
			100% Capacity		90% Capacity		80% Capacity		70% Capacity		60% Capacity		50% Capacity		40% Capacity		30% Capacity	
			TC	PI	TC	PI	TC	PI	TC	PI	TC	PI	TC	PI	TC	PI	TC	PI
Outdoor Unit Dry-Bulb (°C)	Outdoor Unit Wet-Bulb (°C)	Outdoor Unit 100% Heating Capacity (kW)	(kW)	(kW)	(kW)	(kW)	(kW)	(kW)	(kW)	(kW)	(kW)	(kW)	(kW)	(kW)	(kW)	(kW)	(kW)	
15.0	13.7	126.0	126.0	30.78	113.4	26.76	100.8	22.96	88.2	19.39	75.6	16.04	63.0	12.91	50.4	10.01	37.8	7.33
13.0	11.8	126.0	126.0	31.80	113.4	27.63	100.8	23.69	88.2	19.98	75.6	16.51	63.0	13.28	50.4	10.28	37.8	7.51
11.0	9.8	126.0	126.0	32.96	113.4	28.61	100.8	24.50	88.2	20.65	75.6	17.04	63.0	13.69	50.4	10.58	37.8	7.72
9.0	7.9	126.0	126.0	34.13	113.4	29.60	100.8	25.34	88.2	21.33	75.6	17.59	63.0	14.11	50.4	10.89	37.8	7.93
7.0	6.0	126.0	126.0	35.40	113.4	30.68	100.8	26.23	88.2	22.06	75.6	18.17	63.0	14.55	50.4	11.22	37.8	8.16
5.0	4.1	122.3	122.3	35.29	110.1	30.58	97.9	26.15	85.6	22.00	73.4	18.12	61.2	14.51	48.9	11.18	36.7	8.13
3.0	2.2	118.6	118.6	35.19	106.8	30.49	94.9	26.07	83.0	21.93	71.2	18.06	59.3	14.47	47.5	11.15	35.6	8.11
0.0	-0.7	113.0	113.0	35.02	101.7	30.35	90.4	25.95	79.1	21.83	67.8	17.98	56.5	14.40	45.2	11.10	33.9	8.07
-3.0	-3.7	107.2	107.2	34.85	96.5	30.20	85.8	25.82	75.0	21.72	64.3	17.89	53.6	14.33	42.9	11.04	32.2	8.03
-5.0	-5.6	103.5	103.5	34.74	93.2	30.11	82.8	25.74	72.5	21.65	62.1	17.83	51.8	14.28	41.4	11.01	31.1	8.00
-7.0	-7.6	99.6	99.6	34.63	89.7	30.01	79.7	25.66	69.7	21.58	59.8	17.77	49.82	14.24	39.9	10.97	29.9	7.98
-10	-10.5	94.0	94.0	34.47	84.6	29.87	75.2	25.54	65.8	21.48	56.4	17.69	47.01	14.17	37.6	10.92	28.2	7.94
-14.5	-15.0	85.3	85.3	34.21	76.8	29.65	68.2	25.35	59.7	21.32	51.2	17.56	42.65	14.07	34.1	10.84	25.6	7.88
-19.5	-20.0	75.6	75.6	33.93	68.0	29.40	60.5	25.14	52.9	21.14	45.36	17.41	37.80	13.95	30.2	10.75	22.7	7.82

TC : Total Capacity PI : Power Input
 Indoor air temperature conditions : 20.0°C dry-bulb

MMY-UP4211HT8P-E (42HP, 117.4 kW system)

Cooling

Outdoor Unit Dry-Bulb (°C)		Outdoor Unit 100% Cooling Capacity (kW)	Compressor + Outdoor Fan Power consumption (kW)															
			100% Capacity		90% Capacity		80% Capacity		70% Capacity		60% Capacity		50% Capacity		40% Capacity		30% Capacity	
			TC (kW)	PI (kW)	TC (kW)	PI (kW)	TC (kW)	PI (kW)	TC (kW)	PI (kW)	TC (kW)	PI (kW)	TC (kW)	PI (kW)	TC (kW)	PI (kW)	TC (kW)	PI (kW)
46 °C		92.0	41.46	82.8	33.63	73.6	26.62	64.4	20.43	55.2	15.06	46.0	10.50	36.8	6.77	27.6	3.85	
43 °C		100.9	42.21	90.8	34.24	80.7	27.11	70.6	20.80	60.5	15.33	50.4	10.69	40.3	6.89	30.3	3.92	
41 °C		107.4	43.26	96.7	35.09	85.9	27.78	75.2	21.31	64.5	15.71	53.7	10.95	43.0	7.05	32.2	4.01	
39 °C		111.0	42.01	99.9	34.07	88.8	26.97	77.7	20.70	66.6	15.25	55.5	10.64	44.4	6.85	33.3	3.89	
37 °C		114.3	40.73	102.9	33.04	91.5	26.15	80.0	20.07	68.6	14.79	57.2	10.31	45.7	6.64	34.3	3.78	
35 °C		117.4	40.09	105.7	32.01	93.9	25.33	82.2	19.44	70.4	14.33	58.7	9.99	47.0	6.43	35.2	3.66	
32 °C		117.4	36.40	105.7	29.53	93.9	23.37	82.2	17.94	70.4	13.22	58.7	9.22	47.0	5.94	35.2	3.38	
31 °C		117.4	33.69	105.7	27.33	93.9	21.63	82.2	16.60	70.4	12.24	58.7	8.53	47.0	5.50	35.2	3.13	
30 °C		117.4	32.44	105.7	26.32	93.9	20.83	82.2	15.99	70.4	11.78	58.7	8.22	47.0	5.30	35.2	3.01	
29 °C		117.4	31.26	105.7	25.36	93.9	20.08	82.2	15.41	70.4	11.36	58.7	7.92	47.0	5.10	35.2	2.90	
27 °C		117.4	29.08	105.7	23.59	93.9	18.67	82.2	14.33	70.4	10.56	58.7	7.37	47.0	4.75	35.2	2.70	
25 °C		117.4	27.09	105.7	21.98	93.9	17.40	82.2	13.35	70.4	9.84	58.7	6.87	47.0	4.43	35.2	2.52	
23 °C		117.4	25.82	105.7	20.95	93.9	16.58	82.2	12.73	70.4	9.38	58.7	6.55	47.0	4.22	35.2	2.40	
21 °C		117.4	25.22	105.7	20.46	93.9	16.20	82.2	12.43	70.4	9.17	58.7	6.40	47.0	4.12	35.2	2.35	
20 °C		117.4	24.95	105.7	20.24	93.9	16.03	82.2	12.30	70.4	9.07	58.7	6.33	47.0	4.08	35.2	2.32	
19 °C		117.4	24.70	105.7	20.04	93.9	15.87	82.2	12.18	70.4	8.98	58.7	6.27	47.0	4.04	35.2	2.30	
17 °C		117.4	24.26	105.7	19.68	93.9	15.58	82.2	11.96	70.4	8.82	58.7	6.15	47.0	3.97	35.2	2.26	
15 °C		117.4	23.88	105.7	19.37	93.9	15.34	82.2	11.77	70.4	8.68	58.7	6.06	47.0	3.91	35.2	2.22	

TC : Total Capacity PI : Power Input
Indoor air temperature conditions : 27.0°C dry-bulb / 19.0°C wet bulb

Heating

Outdoor Unit Dry-Bulb / Wet-Bulb (°C) / (°C)		Outdoor Unit 100% Heating Capacity (kW)	Compressor + Outdoor Fan Power consumption (kW)															
			100% Capacity		90% Capacity		80% Capacity		70% Capacity		60% Capacity		50% Capacity		40% Capacity		30% Capacity	
			TC (kW)	PI (kW)	TC (kW)	PI (kW)	TC (kW)	PI (kW)	TC (kW)	PI (kW)	TC (kW)	PI (kW)	TC (kW)	PI (kW)	TC (kW)	PI (kW)	TC (kW)	PI (kW)
15.0	13.7	126.0	31.42	113.4	27.70	100.8	24.11	88.2	20.65	75.6	17.31	63.0	14.11	50.4	11.03	37.80	8.08	
13.0	11.8	126.0	32.34	113.4	28.50	100.8	24.79	88.2	21.22	75.6	17.79	63.0	14.49	50.4	11.32	37.80	8.29	
11.0	9.8	126.0	33.37	113.4	29.40	100.8	25.56	88.2	21.87	75.6	18.32	63.0	14.91	50.4	11.64	37.80	8.52	
9.0	7.9	126.0	34.43	113.4	30.31	100.8	26.34	88.2	22.52	75.6	18.86	63.0	15.34	50.4	11.97	37.80	8.75	
7.0	6.0	126.0	35.55	113.4	31.28	100.8	27.17	88.2	23.22	75.6	19.43	63.0	15.79	50.4	12.32	37.80	9.00	
5.0	4.1	122.3	35.44	110.1	31.19	97.9	27.09	85.6	23.15	73.4	19.37	61.2	15.75	48.93	12.28	36.70	8.97	
3.0	2.2	118.6	35.33	106.8	31.09	94.9	27.01	83.0	23.08	71.2	19.31	59.3	15.70	47.45	12.24	35.59	8.95	
0.0	-0.7	113.0	35.17	101.7	30.95	90.4	26.88	79.1	22.97	67.8	19.22	56.5	15.63	45.21	12.19	33.90	8.91	
-3.0	-3.7	107.2	35.00	96.5	30.80	85.8	26.75	75.0	22.86	64.3	19.13	53.6	15.55	42.88	12.13	32.16	8.86	
-5.0	-5.6	103.5	34.89	93.2	30.70	82.8	26.67	72.5	22.79	62.1	19.07	51.8	15.50	41.41	12.09	31.05	8.83	
-7.0	-7.6	99.6	34.78	89.7	30.60	79.7	26.58	69.7	22.72	59.8	19.01	49.82	15.45	39.86	12.05	29.89	8.81	
-10	-10.5	94.0	34.61	84.6	30.46	75.2	26.46	65.8	22.61	56.4	18.92	47.01	15.38	37.61	11.99	28.20	8.76	
-14.5	-15.0	85.3	34.36	76.8	30.23	68.2	26.26	59.7	22.44	51.2	18.78	42.65	15.26	34.12	11.91	25.59	8.70	
-19.5	-20.0	75.6	34.07	68.0	29.98	60.5	26.04	52.9	22.26	45.36	18.62	37.80	15.14	30.24	11.81	22.68	8.63	

TC : Total Capacity PI : Power Input
Indoor air temperature conditions : 20.0°C dry-bulb

MMY-UP4411HT8P-E (44HP, 123.0 kW system)

Cooling		Compressor + Outdoor Fan Power consumption (kW)															
		100% Capacity		90% Capacity		80% Capacity		70% Capacity		60% Capacity		50% Capacity		40% Capacity		30% Capacity	
		TC	PI	TC	PI	TC	PI	TC	PI	TC	PI	TC	PI	TC	PI	TC	PI
Outdoor Unit Dry-Bulb (°C)	Outdoor Unit 100% Cooling Capacity (kW)	(kW)	(kW)	(kW)	(kW)	(kW)	(kW)	(kW)	(kW)	(kW)	(kW)	(kW)	(kW)	(kW)	(kW)	(kW)	
46 °C	96.3	96.3	43.39	86.7	35.15	77.1	27.78	67.4	21.28	57.8	15.65	48.2	10.88	38.5	6.98	28.9	3.95
43 °C	105.7	105.7	44.19	95.1	35.80	84.5	28.30	74.0	21.68	63.4	15.94	52.8	11.08	42.3	7.11	31.7	4.02
41 °C	112.6	112.6	45.30	101.3	36.70	90.0	29.01	78.8	22.22	67.5	16.34	56.3	11.36	45.0	7.28	33.8	4.12
39 °C	116.3	116.3	43.99	104.7	35.64	93.0	28.17	81.4	21.58	69.8	15.86	58.2	11.03	46.5	7.07	34.9	4.00
37 °C	119.8	119.8	42.66	107.8	34.56	95.8	27.31	83.8	20.92	71.9	15.38	59.9	10.69	47.9	6.86	35.9	3.88
35 °C	123.0	123.0	42.20	110.7	33.48	98.4	26.46	86.1	20.27	73.8	14.90	61.5	10.36	49.2	6.64	36.9	3.75
32 °C	123.0	123.0	38.11	110.7	30.88	98.4	24.40	86.1	18.69	73.8	13.74	61.5	9.56	49.2	6.13	36.9	3.46
31 °C	123.0	123.0	35.26	110.7	28.57	98.4	22.58	86.1	17.30	73.8	12.72	61.5	8.84	49.2	5.67	36.9	3.21
30 °C	123.0	123.0	33.96	110.7	27.51	98.4	21.74	86.1	16.66	73.8	12.25	61.5	8.52	49.2	5.46	36.9	3.09
29 °C	123.0	123.0	32.72	110.7	26.51	98.4	20.95	86.1	16.05	73.8	11.80	61.5	8.21	49.2	5.26	36.9	2.98
27 °C	123.0	123.0	30.42	110.7	24.65	98.4	19.48	86.1	14.92	73.8	10.97	61.5	7.63	49.2	4.90	36.9	2.77
25 °C	123.0	123.0	28.34	110.7	22.96	98.4	18.15	86.1	13.90	73.8	10.22	61.5	7.11	49.2	4.56	36.9	2.58
23 °C	123.0	123.0	27.01	110.7	21.88	98.4	17.30	86.1	13.25	73.8	9.74	61.5	6.78	49.2	4.35	36.9	2.46
21 °C	123.0	123.0	26.37	110.7	21.37	98.4	16.89	86.1	12.94	73.8	9.51	61.5	6.62	49.2	4.25	36.9	2.40
20 °C	123.0	123.0	26.09	110.7	21.14	98.4	16.71	86.1	12.80	73.8	9.41	61.5	6.55	49.2	4.20	36.9	2.38
19 °C	123.0	123.0	25.83	110.7	20.93	98.4	16.54	86.1	12.67	73.8	9.32	61.5	6.48	49.2	4.16	36.9	2.35
17 °C	123.0	123.0	25.36	110.7	20.55	98.4	16.24	86.1	12.44	73.8	9.15	61.5	6.36	49.2	4.08	36.9	2.31
15 °C	123.0	123.0	24.96	110.7	20.23	98.4	15.99	86.1	12.25	73.8	9.01	61.5	6.26	49.2	4.02	36.9	2.28

TC : Total Capacity PI : Power Input
 Indoor air temperature conditions : 27.0°C dry-bulb / 19.0°C wet bulb

Heating			Compressor + Outdoor Fan Power consumption (kW)																	
			Outdoor Unit 100% Heating Capacity (kW)		100% Capacity		90% Capacity		80% Capacity		70% Capacity		60% Capacity		50% Capacity		40% Capacity		30% Capacity	
			TC	PI	TC	PI	TC	PI	TC	PI	TC	PI	TC	PI	TC	PI	TC	PI	TC	PI
Outdoor Unit Dry-Bulb (°C)	Outdoor Unit Wet-Bulb (°C)	(kW)	(kW)	(kW)	(kW)	(kW)	(kW)	(kW)	(kW)	(kW)	(kW)	(kW)	(kW)	(kW)	(kW)	(kW)	(kW)	(kW)		
15.0	13.7	133.0	133.0	33.91	119.7	29.84	106.4	25.92	93.1	22.17	79.8	18.57	66.5	15.13	53.2	11.85	39.9	8.73		
13.0	11.8	133.0	133.0	34.93	119.7	30.71	106.4	26.67	93.1	22.79	79.8	19.08	66.5	15.54	53.2	12.16	39.9	8.95		
11.0	9.8	133.0	133.0	36.07	119.7	31.70	106.4	27.51	93.1	23.49	79.8	19.65	66.5	15.99	53.2	12.50	39.9	9.19		
9.0	7.9	133.0	133.0	37.23	119.7	32.70	106.4	28.36	93.1	24.20	79.8	20.23	66.5	16.45	53.2	12.85	39.9	9.44		
7.0	6.0	133.0	133.0	38.47	119.7	33.77	106.4	29.27	93.1	24.96	79.8	20.85	66.5	16.94	53.2	13.22	39.9	9.70		
5.0	4.1	129.1	129.1	38.35	116.2	33.67	103.3	29.18	90.4	24.89	77.5	20.79	64.6	16.89	51.6	13.18	38.7	9.67		
3.0	2.2	125.2	125.2	38.24	112.7	33.57	100.2	29.09	87.7	24.81	75.1	20.73	62.6	16.84	50.1	13.14	37.6	9.64		
0.0	-0.7	119.3	119.3	38.06	107.4	33.41	95.4	28.95	83.5	24.69	71.6	20.63	59.6	16.76	47.7	13.08	35.8	9.60		
-3.0	-3.7	113.2	113.2	37.87	101.8	33.25	90.5	28.81	79.2	24.57	67.9	20.53	56.6	16.68	45.3	13.02	33.9	9.55		
-5.0	-5.6	109.3	109.3	37.76	98.3	33.14	87.4	28.73	76.5	24.50	65.6	20.47	54.6	16.62	43.7	12.98	32.8	9.52		
-7.0	-7.6	105.2	105.2	37.63	94.7	33.04	84.1	28.63	73.6	24.42	63.1	20.40	52.6	16.57	42.1	12.93	31.6	9.49		
-10	-10.5	99.2	99.2	37.45	89.3	32.88	79.4	28.50	69.5	24.30	59.5	20.30	49.6	16.49	39.7	12.87	29.8	9.44		
-14.5	-15.0	90.0	90.0	37.18	81.0	32.64	72.0	28.29	63.0	24.12	54.0	20.15	45.0	16.37	36.0	12.78	27.0	9.37		
-19.5	-20.0	79.8	79.8	36.87	71.8	32.37	63.8	28.05	55.9	23.92	47.9	19.98	39.9	16.23	31.9	12.67	23.9	9.30		

TC : Total Capacity PI : Power Input
 Indoor air temperature conditions : 20.0°C dry-bulb

MMY-UP4611HT8P-E (46HP, 128.5 kW system)

Cooling

Outdoor Unit Dry-Bulb (°C)	Outdoor Unit 100% Cooling Capacity (kW)	Compressor + Outdoor Fan Power consumption (kW)															
		100% Capacity		90% Capacity		80% Capacity		70% Capacity		60% Capacity		50% Capacity		40% Capacity		30% Capacity	
		TC	PI	TC	PI	TC	PI	TC	PI	TC	PI	TC	PI	TC	PI	TC	PI
		(kW)	(kW)	(kW)	(kW)	(kW)	(kW)	(kW)	(kW)	(kW)	(kW)	(kW)	(kW)	(kW)	(kW)	(kW)	(kW)
46 °C	100.6	100.6	45.88	90.6	37.19	80.5	29.41	70.5	22.54	60.4	16.60	50.3	11.56	40.3	7.44	30.2	4.24
43 °C	110.4	110.4	46.73	99.4	37.87	88.3	29.95	77.3	22.96	66.2	16.90	55.2	11.77	44.2	7.57	33.1	4.31
41 °C	117.6	117.6	47.90	105.8	38.82	94.1	30.70	82.3	23.53	70.6	17.32	58.8	12.06	47.0	7.76	35.3	4.41
39 °C	121.5	121.5	46.51	109.4	37.69	97.2	29.81	85.1	22.85	72.9	16.81	60.8	11.71	48.6	7.53	36.5	4.29
37 °C	125.1	125.1	45.10	112.6	36.55	100.1	28.90	87.6	22.15	75.1	16.30	62.6	11.36	50.1	7.31	37.5	4.16
35 °C	128.5	128.5	44.62	115.7	35.41	102.8	28.00	90.0	21.46	77.1	15.79	64.3	11.00	51.4	7.08	38.6	4.03
32 °C	128.5	128.5	40.30	115.7	32.66	102.8	25.83	90.0	19.80	77.1	14.57	64.3	10.15	51.4	6.53	38.6	3.72
31 °C	128.5	128.5	37.29	115.7	30.22	102.8	23.90	90.0	18.32	77.1	13.49	64.3	9.39	51.4	6.05	38.6	3.44
30 °C	128.5	128.5	35.91	115.7	29.10	102.8	23.01	90.0	17.64	77.1	12.99	64.3	9.05	51.4	5.82	38.6	3.32
29 °C	128.5	128.5	34.60	115.7	28.04	102.8	22.18	90.0	17.00	77.1	12.52	64.3	8.72	51.4	5.61	38.6	3.20
27 °C	128.5	128.5	32.17	115.7	26.08	102.8	20.62	90.0	15.81	77.1	11.64	64.3	8.11	51.4	5.22	38.6	2.98
25 °C	128.5	128.5	29.97	115.7	24.29	102.8	19.21	90.0	14.73	77.1	10.84	64.3	7.56	51.4	4.87	38.6	2.78
23 °C	128.5	128.5	28.56	115.7	23.15	102.8	18.31	90.0	14.04	77.1	10.34	64.3	7.20	51.4	4.64	38.6	2.65
21 °C	128.5	128.5	27.90	115.7	22.61	102.8	17.88	90.0	13.71	77.1	10.10	64.3	7.04	51.4	4.53	38.6	2.59
20 °C	128.5	128.5	27.60	115.7	22.37	102.8	17.69	90.0	13.57	77.1	9.99	64.3	6.96	51.4	4.49	38.6	2.56
19 °C	128.5	128.5	27.32	115.7	22.15	102.8	17.52	90.0	13.43	77.1	9.89	64.3	6.89	51.4	4.44	38.6	2.54
17 °C	128.5	128.5	26.83	115.7	21.75	102.8	17.20	90.0	13.19	77.1	9.71	64.3	6.77	51.4	4.36	38.6	2.49
15 °C	128.5	128.5	26.41	115.7	21.40	102.8	16.93	90.0	12.98	77.1	9.56	64.3	6.66	51.4	4.30	38.6	2.45

TC : Total Capacity PI : Power Input
Indoor air temperature conditions : 27.0°C dry-bulb / 19.0°C wet bulb

Heating

Outdoor Unit Dry-Bulb (°C)		Outdoor Unit 100% Heating Capacity (kW)		Compressor + Outdoor Fan Power consumption (kW)															
				100% Capacity		90% Capacity		80% Capacity		70% Capacity		60% Capacity		50% Capacity		40% Capacity		30% Capacity	
				TC	PI	TC	PI	TC	PI	TC	PI	TC	PI	TC	PI	TC	PI	TC	PI
				(kW)	(kW)	(kW)	(kW)	(kW)	(kW)	(kW)	(kW)	(kW)	(kW)	(kW)	(kW)	(kW)	(kW)	(kW)	(kW)
15.0	13.7	139.0	139.0	35.22	125.1	31.11	111.2	27.12	97.3	23.27	83.4	19.55	69.5	15.96	55.6	12.51	41.7	9.18	
13.0	11.8	139.0	139.0	36.24	125.1	31.99	111.2	27.88	97.3	23.91	83.4	20.08	69.5	16.39	55.6	12.83	41.7	9.42	
11.0	9.8	139.0	139.0	37.38	125.1	32.99	111.2	28.74	97.3	24.63	83.4	20.67	69.5	16.86	55.6	13.20	41.7	9.68	
9.0	7.9	139.0	139.0	38.54	125.1	33.99	111.2	29.60	97.3	25.36	83.4	21.27	69.5	17.34	55.6	13.57	41.7	9.94	
7.0	6.0	139.0	139.0	39.78	125.1	35.07	111.2	30.52	97.3	26.14	83.4	21.91	69.5	17.85	55.6	13.96	41.7	10.22	
5.0	4.1	134.9	134.9	39.66	121.4	34.96	108.0	30.43	94.5	26.06	81.0	21.85	67.5	17.80	54.0	13.91	40.5	10.19	
3.0	2.2	130.9	130.9	39.54	117.8	34.86	104.7	30.34	91.6	25.98	78.5	21.78	65.4	17.75	52.4	13.87	39.3	10.16	
0.0	-0.7	124.7	124.7	39.35	112.2	34.69	99.7	30.19	87.3	25.86	74.8	21.68	62.3	17.66	49.9	13.81	37.4	10.11	
-3.0	-3.7	118.3	118.3	39.16	106.4	34.52	94.6	30.05	82.8	25.73	71.0	21.57	59.1	17.58	47.3	13.74	35.5	10.06	
-5.0	-5.6	114.2	114.2	39.04	102.8	34.42	91.4	29.95	79.9	25.65	68.5	21.51	57.1	17.52	45.7	13.70	34.3	10.03	
-7.0	-7.6	109.9	109.9	38.91	98.9	34.31	87.9	29.86	76.9	25.57	66.0	21.44	55.0	17.47	44.0	13.65	33.0	10.00	
-10	-10.5	103.7	103.7	38.73	93.3	34.14	83.0	29.72	72.6	25.45	62.2	21.33	51.9	17.38	41.5	13.59	31.1	9.95	
-14.5	-15.0	94.1	94.1	38.44	84.7	33.89	75.3	29.50	65.9	25.26	56.5	21.18	47.0	17.25	37.6	13.49	28.2	9.88	
-19.5	-20.0	83.4	83.4	38.13	75.1	33.61	66.7	29.25	58.4	25.05	50.0	21.00	41.7	17.11	33.4	13.38	25.0	9.80	

TC : Total Capacity PI : Power Input
Indoor air temperature conditions : 20.0°C dry-bulb

MMY-UP4811HT8P-E (48HP, 134.0 kW system)

Cooling		Compressor + Outdoor Fan Power consumption (kW)															
		100% Capacity		90% Capacity		80% Capacity		70% Capacity		60% Capacity		50% Capacity		40% Capacity		30% Capacity	
		TC	PI	TC	PI	TC	PI	TC	PI	TC	PI	TC	PI	TC	PI	TC	PI
Outdoor Unit Dry-Bulb (°C)	Outdoor Unit 100% Cooling Capacity (kW)	(kW)	(kW)	(kW)	(kW)	(kW)	(kW)	(kW)	(kW)	(kW)	(kW)	(kW)	(kW)	(kW)	(kW)	(kW)	
46 °C	105.0	105.0	49.74	94.5	40.29	84.0	31.83	73.5	24.37	63.0	17.91	52.5	12.43	42.0	7.96	31.5	4.48
43 °C	115.1	115.1	50.66	103.6	41.04	92.1	32.43	80.6	24.83	69.1	18.24	57.6	12.67	46.0	8.11	34.5	4.56
41 °C	122.6	122.6	51.94	110.4	42.07	98.1	33.24	85.8	25.45	73.6	18.70	61.3	12.99	49.0	8.31	36.8	4.67
39 °C	126.7	126.7	50.43	114.0	40.85	101.4	32.28	88.7	24.71	76.0	18.16	63.4	12.61	50.7	8.07	38.0	4.54
37 °C	130.5	130.5	48.90	117.4	39.61	104.4	31.30	91.3	23.96	78.3	17.61	65.2	12.23	52.2	7.82	39.1	4.40
35 °C	134.0	134.0	48.38	120.6	38.37	107.2	30.32	93.8	23.21	80.4	17.06	67.0	11.84	53.6	7.58	40.2	4.26
32 °C	134.0	134.0	43.69	120.6	35.39	107.2	27.96	93.8	21.41	80.4	15.73	67.0	10.92	53.6	6.99	40.2	3.93
31 °C	134.0	134.0	40.42	120.6	32.74	107.2	25.87	93.8	19.81	80.4	14.55	67.0	10.11	53.6	6.47	40.2	3.64
30 °C	134.0	134.0	38.93	120.6	31.53	107.2	24.91	93.8	19.07	80.4	14.01	67.0	9.73	53.6	6.23	40.2	3.50
29 °C	134.0	134.0	37.51	120.6	30.38	107.2	24.00	93.8	18.38	80.4	13.50	67.0	9.38	53.6	6.00	40.2	3.38
27 °C	134.0	134.0	34.87	120.6	28.25	107.2	22.32	93.8	17.09	80.4	12.55	67.0	8.72	53.6	5.58	40.2	3.14
25 °C	134.0	134.0	32.48	120.6	26.31	107.2	20.79	93.8	15.92	80.4	11.69	67.0	8.12	53.6	5.20	40.2	2.92
23 °C	134.0	134.0	30.96	120.6	25.07	107.2	19.81	93.8	15.17	80.4	11.14	67.0	7.74	53.6	4.95	40.2	2.79
21 °C	134.0	134.0	30.23	120.6	24.49	107.2	19.35	93.8	14.81	80.4	10.88	67.0	7.56	53.6	4.84	40.2	2.72
20 °C	134.0	134.0	29.90	120.6	24.22	107.2	19.14	93.8	14.65	80.4	10.77	67.0	7.48	53.6	4.78	40.2	2.69
19 °C	134.0	134.0	29.60	120.6	23.98	107.2	18.95	93.8	14.51	80.4	10.66	67.0	7.40	53.6	4.74	40.2	2.66
17 °C	134.0	134.0	29.07	120.6	23.54	107.2	18.60	93.8	14.24	80.4	10.46	67.0	7.27	53.6	4.65	40.2	2.62
15 °C	134.0	134.0	28.61	120.6	23.17	107.2	18.31	93.8	14.02	80.4	10.30	67.0	7.15	53.6	4.58	40.2	2.57

TC : Total Capacity PI : Power Input
 Indoor air temperature conditions : 27.0°C dry-bulb / 19.0°C wet bulb

Heating			Compressor + Outdoor Fan Power consumption (kW)															
			100% Capacity		90% Capacity		80% Capacity		70% Capacity		60% Capacity		50% Capacity		40% Capacity		30% Capacity	
			TC	PI	TC	PI	TC	PI	TC	PI	TC	PI	TC	PI	TC	PI	TC	PI
Outdoor Unit Dry-Bulb (°C)	Outdoor Unit Wet-Bulb (°C)	Outdoor Unit 100% Heating Capacity (kW)	(kW)	(kW)	(kW)	(kW)	(kW)	(kW)	(kW)	(kW)	(kW)	(kW)	(kW)	(kW)	(kW)	(kW)		
15.0	13.7	140.0	140.0	37.04	126.0	32.92	112.0	28.88	98.0	24.95	84.0	21.10	70.0	17.35	56.0	13.69	42.0	10.13
13.0	11.8	140.0	140.0	38.05	126.0	33.80	112.0	29.65	98.0	25.60	84.0	21.65	70.0	17.79	56.0	14.04	42.0	10.38
11.0	9.8	140.0	140.0	39.18	126.0	34.79	112.0	30.51	98.0	26.33	84.0	22.26	70.0	18.29	56.0	14.42	42.0	10.66
9.0	7.9	140.0	140.0	40.32	126.0	35.80	112.0	31.38	98.0	27.07	84.0	22.88	70.0	18.79	56.0	14.81	42.0	10.95
7.0	6.0	140.0	140.0	41.54	126.0	36.86	112.0	32.31	98.0	27.86	84.0	23.53	70.0	19.32	56.0	15.23	42.0	11.25
5.0	4.1	135.9	135.9	41.41	122.3	36.75	108.7	32.21	95.1	27.78	81.5	23.46	68.0	19.26	54.4	15.18	40.8	11.21
3.0	2.2	131.8	131.8	41.29	118.6	36.64	105.5	32.11	92.3	27.69	79.1	23.39	65.9	19.21	52.7	15.13	39.5	11.18
0.0	-0.7	125.6	125.6	41.10	113.0	36.47	100.5	31.96	87.9	27.56	75.3	23.28	62.8	19.12	50.2	15.06	37.7	11.13
-3.0	-3.7	119.1	119.1	40.90	107.2	36.29	95.3	31.80	83.4	27.43	71.5	23.17	59.6	19.02	47.6	14.99	35.7	11.07
-5.0	-5.6	115.0	115.0	40.77	103.5	36.18	92.0	31.71	80.5	27.35	69.0	23.10	57.5	18.96	46.0	14.94	34.5	11.04
-7.0	-7.6	110.7	110.7	40.64	99.6	36.06	88.6	31.60	77.5	27.26	66.4	23.02	55.4	18.90	44.3	14.90	33.2	11.00
-10	-10.5	104.5	104.5	40.44	94.0	35.89	83.6	31.45	73.1	27.13	62.7	22.91	52.2	18.81	41.8	14.82	31.3	10.95
-14.5	-15.0	94.8	94.8	40.14	85.3	35.63	75.8	31.22	66.3	26.93	56.9	22.74	47.4	18.67	37.9	14.71	28.4	10.87
-19.5	-20.0	84.0	84.0	39.81	75.6	35.33	67.2	30.96	58.8	26.70	50.4	22.56	42.0	18.52	33.6	14.59	25.2	10.78

TC : Total Capacity PI : Power Input
 Indoor air temperature conditions : 20.0°C dry-bulb

MMY-UP5011HT8P-E (50HP, 140.5 kW system)

Cooling		Compressor + Outdoor Fan Power consumption (kW)															
		100% Capacity		90% Capacity		80% Capacity		70% Capacity		60% Capacity		50% Capacity		40% Capacity		30% Capacity	
		TC	PI	TC	PI	TC	PI	TC	PI	TC	PI	TC	PI	TC	PI	TC	PI
Outdoor Unit Dry-Bulb (°C)	Outdoor Unit 100% Cooling Capacity (kW)	(kW)	(kW)	(kW)	(kW)	(kW)	(kW)	(kW)	(kW)	(kW)	(kW)	(kW)	(kW)	(kW)	(kW)	(kW)	
46 °C	110.0	110.0	50.43	99.0	40.90	88.0	32.36	77.0	24.82	66.0	18.28	55.0	12.74	44.0	8.19	33.0	4.65
43 °C	120.7	120.7	51.36	108.6	41.65	96.6	32.95	84.5	25.27	72.4	18.61	60.3	12.97	48.3	8.34	36.2	4.73
41 °C	128.6	128.6	52.64	115.7	42.68	102.9	33.77	90.0	25.90	77.1	19.07	64.3	13.29	51.4	8.55	38.6	4.85
39 °C	132.8	132.8	51.11	119.6	41.44	106.3	32.79	93.0	25.15	79.7	18.52	66.4	12.90	53.1	8.30	39.9	4.70
37 °C	136.8	136.8	49.56	123.1	40.19	109.5	31.80	95.8	24.39	82.1	17.96	68.4	12.51	54.7	8.05	41.0	4.56
35 °C	140.5	140.5	49.08	126.5	38.93	112.4	30.80	98.4	23.62	84.3	17.40	70.3	12.12	56.2	7.79	42.2	4.42
32 °C	140.5	140.5	44.29	126.5	35.91	112.4	28.41	98.4	21.79	84.3	16.05	70.3	11.18	56.2	7.19	42.2	4.08
31 °C	140.5	140.5	40.98	126.5	33.23	112.4	26.30	98.4	20.17	84.3	14.86	70.3	10.35	56.2	6.66	42.2	3.78
30 °C	140.5	140.5	39.47	126.5	32.01	112.4	25.33	98.4	19.43	84.3	14.31	70.3	9.97	56.2	6.41	42.2	3.64
29 °C	140.5	140.5	38.03	126.5	30.84	112.4	24.40	98.4	18.72	84.3	13.79	70.3	9.61	56.2	6.18	42.2	3.51
27 °C	140.5	140.5	35.37	126.5	28.68	112.4	22.70	98.4	17.41	84.3	12.82	70.3	8.94	56.2	5.75	42.2	3.26
25 °C	140.5	140.5	32.95	126.5	26.72	112.4	21.14	98.4	16.22	84.3	11.95	70.3	8.33	56.2	5.36	42.2	3.04
23 °C	140.5	140.5	31.41	126.5	25.47	112.4	20.15	98.4	15.46	84.3	11.39	70.3	7.94	56.2	5.11	42.2	2.90
21 °C	140.5	140.5	30.67	126.5	24.88	112.4	19.68	98.4	15.10	84.3	11.12	70.3	7.75	56.2	4.99	42.2	2.83
20 °C	140.5	140.5	30.35	126.5	24.61	112.4	19.47	98.4	14.94	84.3	11.01	70.3	7.67	56.2	4.94	42.2	2.80
19 °C	140.5	140.5	30.04	126.5	24.36	112.4	19.28	98.4	14.79	84.3	10.90	70.3	7.59	56.2	4.89	42.2	2.77
17 °C	140.5	140.5	29.50	126.5	23.93	112.4	18.93	98.4	14.53	84.3	10.70	70.3	7.46	56.2	4.80	42.2	2.72
15 °C	140.5	140.5	29.04	126.5	23.55	112.4	18.64	98.4	14.30	84.3	10.53	70.3	7.34	56.2	4.73	42.2	2.68

TC : Total Capacity PI : Power Input
 Indoor air temperature conditions : 27.0°C dry-bulb / 19.0°C wet bulb

Heating		Compressor + Outdoor Fan Power consumption (kW)																	
		Outdoor Unit 100% Heating Capacity		100% Capacity		90% Capacity		80% Capacity		70% Capacity		60% Capacity		50% Capacity		40% Capacity		30% Capacity	
		TC	PI	TC	PI	TC	PI	TC	PI	TC	PI	TC	PI	TC	PI	TC	PI	TC	PI
Outdoor Unit Dry-Bulb (°C)	Outdoor Unit Wet-Bulb (°C)	(kW)	(kW)	(kW)	(kW)	(kW)	(kW)	(kW)	(kW)	(kW)	(kW)	(kW)	(kW)	(kW)	(kW)	(kW)	(kW)	(kW)	
15.0	13.7	152.5	152.5	36.81	137.3	32.37	122.0	28.09	106.8	23.99	91.5	20.06	76.3	16.29	61.0	12.70	45.8	9.27	
13.0	11.8	152.5	152.5	37.91	137.3	33.32	122.0	28.91	106.8	24.67	91.5	20.62	76.3	16.74	61.0	13.04	45.8	9.51	
11.0	9.8	152.5	152.5	39.16	137.3	34.40	122.0	29.83	106.8	25.44	91.5	21.24	76.3	17.24	61.0	13.41	45.8	9.78	
9.0	7.9	152.5	152.5	40.42	137.3	35.49	122.0	30.75	106.8	26.22	91.5	21.88	76.3	17.74	61.0	13.80	45.8	10.05	
7.0	6.0	152.5	152.5	41.77	137.3	36.65	122.0	31.75	106.8	27.05	91.5	22.56	76.3	18.28	61.0	14.20	45.8	10.34	
5.0	4.1	148.0	148.0	41.64	133.2	36.54	118.4	31.65	103.6	26.97	88.8	22.49	74.0	18.22	59.2	14.16	44.4	10.31	
3.0	2.2	143.6	143.6	41.52	129.2	36.43	114.9	31.55	100.5	26.88	86.2	22.42	71.8	18.17	57.4	14.12	43.1	10.28	
0.0	-0.7	136.8	136.8	41.32	123.1	36.26	109.4	31.41	95.7	26.76	82.1	22.32	68.4	18.08	54.7	14.05	41.0	10.23	
-3.0	-3.7	129.7	129.7	41.12	116.8	36.09	103.8	31.25	90.8	26.63	77.8	22.21	64.9	17.99	51.9	13.98	38.9	10.18	
-5.0	-5.6	125.3	125.3	41.00	112.8	35.97	100.2	31.16	87.7	26.55	75.2	22.14	62.6	17.94	50.1	13.94	37.6	10.15	
-7.0	-7.6	120.6	120.6	40.86	108.5	35.86	96.5	31.06	84.4	26.46	72.4	22.07	60.3	17.88	48.2	13.90	36.2	10.12	
-10	-10.5	113.8	113.8	40.67	102.4	35.69	91.0	30.91	79.7	26.33	68.3	21.96	56.9	17.79	45.5	13.83	34.1	10.07	
-14.5	-15.0	103.2	103.2	40.37	92.9	35.42	82.6	30.68	72.3	26.14	61.9	21.80	51.6	17.66	41.3	13.73	31.0	9.99	
-19.5	-20.0	91.5	91.5	40.03	82.4	35.13	73.2	30.43	64.1	25.92	54.9	21.62	45.8	17.52	36.6	13.61	27.5	9.91	

TC : Total Capacity PI : Power Input
 Indoor air temperature conditions : 20.0°C dry-bulb

MMY-UP5211HT8P-E (52HP, 147.0 kW system)

Cooling		Compressor + Outdoor Fan Power consumption (kW)																	
		Outdoor Unit		100% Capacity		90% Capacity		80% Capacity		70% Capacity		60% Capacity		50% Capacity		40% Capacity		30% Capacity	
		Dry-Bulb (°C)	100% Cooling Capacity (kW)	TC (kW)	PI (kW)	TC (kW)	PI (kW)	TC (kW)	PI (kW)	TC (kW)	PI (kW)	TC (kW)	PI (kW)	TC (kW)	PI (kW)	TC (kW)	PI (kW)	TC (kW)	PI (kW)
46 °C	115.1	115.1	54.78	103.6	44.37	92.1	35.06	80.6	26.84	69.1	19.72	57.6	13.69	46.1	8.76	34.5	4.93		
43 °C	126.3	126.3	55.80	113.7	45.20	101.0	35.71	88.4	27.34	75.8	20.09	63.1	13.95	50.5	8.93	37.9	5.02		
41 °C	134.5	134.5	57.21	121.1	46.34	107.6	36.61	94.2	28.03	80.7	20.59	67.3	14.30	53.8	9.15	40.4	5.15		
39 °C	139.0	139.0	55.54	125.1	44.99	111.2	35.55	97.3	27.22	83.4	20.00	69.5	13.89	55.6	8.89	41.7	5.00		
37 °C	143.1	143.1	53.86	128.8	43.63	114.5	34.47	100.2	26.39	85.9	19.39	71.6	13.47	57.3	8.62	42.9	4.85		
35 °C	147.0	147.0	53.29	132.3	42.26	117.6	33.39	102.9	25.57	88.2	18.78	73.5	13.04	58.8	8.35	44.1	4.70		
32 °C	147.0	147.0	48.12	132.3	38.98	117.6	30.80	102.9	23.58	88.2	17.32	73.5	12.03	58.8	7.70	44.1	4.33		
31 °C	147.0	147.0	44.52	132.3	36.06	117.6	28.49	102.9	21.82	88.2	16.03	73.5	11.13	58.8	7.12	44.1	4.01		
30 °C	147.0	147.0	42.87	132.3	34.73	117.6	27.44	102.9	21.01	88.2	15.43	73.5	10.72	58.8	6.86	44.1	3.86		
29 °C	147.0	147.0	41.31	132.3	33.46	117.6	26.44	102.9	20.24	88.2	14.87	73.5	10.33	58.8	6.61	44.1	3.72		
27 °C	147.0	147.0	38.41	132.3	31.11	117.6	24.58	102.9	18.82	88.2	13.83	73.5	9.60	58.8	6.15	44.1	3.46		
25 °C	147.0	147.0	35.77	132.3	28.98	117.6	22.89	102.9	17.53	88.2	12.88	73.5	8.94	58.8	5.72	44.1	3.22		
23 °C	147.0	147.0	34.09	132.3	27.61	117.6	21.82	102.9	16.71	88.2	12.27	73.5	8.52	58.8	5.45	44.1	3.07		
21 °C	147.0	147.0	33.29	132.3	26.97	117.6	21.31	102.9	16.31	88.2	11.99	73.5	8.32	58.8	5.33	44.1	3.00		
20 °C	147.0	147.0	32.94	132.3	26.68	117.6	21.08	102.9	16.14	88.2	11.86	73.5	8.23	58.8	5.27	44.1	2.96		
19 °C	147.0	147.0	32.60	132.3	26.41	117.6	20.87	102.9	15.98	88.2	11.74	73.5	8.15	58.8	5.22	44.1	2.93		
17 °C	147.0	147.0	32.01	132.3	25.93	117.6	20.49	102.9	15.69	88.2	11.52	73.5	8.00	58.8	5.12	44.1	2.88		
15 °C	147.0	147.0	31.51	132.3	25.52	117.6	20.17	102.9	15.44	88.2	11.34	73.5	7.88	58.8	5.04	44.1	2.84		

TC : Total Capacity PI : Power Input
 Indoor air temperature conditions : 27.0°C dry-bulb / 19.0°C wet bulb

Heating			Compressor + Outdoor Fan Power consumption (kW)																	
			Outdoor Unit		100% Capacity		90% Capacity		80% Capacity		70% Capacity		60% Capacity		50% Capacity		40% Capacity		30% Capacity	
			Dry-Bulb (°C)	Wet-Bulb (°C)	Heating Capacity (kW)	TC (kW)	PI (kW)	TC (kW)	PI (kW)	TC (kW)	PI (kW)	TC (kW)	PI (kW)	TC (kW)	PI (kW)	TC (kW)	PI (kW)	TC (kW)	PI (kW)	
15.0	13.7	160.0	160.0	39.53	144.0	34.65	128.0	29.97	112.0	25.50	96.0	21.24	80.0	17.18	64.0	13.33	48.0	9.69		
13.0	11.8	160.0	160.0	40.76	144.0	35.70	128.0	30.87	112.0	26.25	96.0	21.85	80.0	17.66	64.0	13.69	48.0	9.95		
11.0	9.8	160.0	160.0	42.13	144.0	36.89	128.0	31.87	112.0	27.08	96.0	22.53	80.0	18.20	64.0	14.10	48.0	10.23		
9.0	7.9	160.0	160.0	43.53	144.0	38.09	128.0	32.89	112.0	27.93	96.0	23.22	80.0	18.74	64.0	14.51	48.0	10.52		
7.0	6.0	160.0	160.0	45.03	144.0	39.38	128.0	33.98	112.0	28.84	96.0	23.95	80.0	19.32	64.0	14.95	48.0	10.83		
5.0	4.1	155.3	155.3	44.89	139.8	39.26	124.3	33.88	108.7	28.75	93.2	23.88	77.7	19.26	62.1	14.90	46.6	10.79		
3.0	2.2	150.6	150.6	44.76	135.6	39.14	120.5	33.77	105.5	28.66	90.4	23.81	75.3	19.21	60.3	14.86	45.2	10.76		
0.0	-0.7	143.5	143.5	44.55	129.2	38.96	114.8	33.62	100.5	28.53	86.1	23.70	71.8	19.12	57.4	14.79	43.1	10.71		
-3.0	-3.7	136.1	136.1	44.33	122.5	38.77	108.9	33.45	95.3	28.39	81.7	23.58	68.1	19.02	54.4	14.72	40.8	10.66		
-5.0	-5.6	131.4	131.4	44.19	118.3	38.65	105.2	33.35	92.0	28.30	78.9	23.51	65.7	18.96	52.6	14.67	39.4	10.63		
-7.0	-7.6	126.5	126.5	44.05	113.9	38.52	101.2	33.24	88.6	28.21	75.9	23.43	63.3	18.90	50.6	14.62	38.0	10.59		
-10	-10.5	119.4	119.4	43.84	107.4	38.34	95.5	33.08	83.6	28.08	71.6	23.32	59.7	18.81	47.8	14.55	35.8	10.54		
-14.5	-15.0	108.3	108.3	43.52	97.5	38.06	86.6	32.84	75.8	27.87	65.0	23.15	54.2	18.67	43.3	14.45	32.5	10.46		
-19.5	-20.0	96.0	96.0	43.16	86.4	37.74	76.8	32.57	67.2	27.64	57.60	22.96	48.0	18.52	38.4	14.33	28.8	10.38		

TC : Total Capacity PI : Power Input
 Indoor air temperature conditions : 20.0°C dry-bulb

MMY-UP5411HT8P-E (54HP, 152.0 kW system)

Outdoor Unit Dry-Bulb (°C)		Outdoor Unit 100% Cooling Capacity (kW)	Compressor + Outdoor Fan Power consumption (kW)															
			100% Capacity		90% Capacity		80% Capacity		70% Capacity		60% Capacity		50% Capacity		40% Capacity		30% Capacity	
			TC (kW)	PI (kW)	TC (kW)	PI (kW)	TC (kW)	PI (kW)	TC (kW)	PI (kW)	TC (kW)	PI (kW)	TC (kW)	PI (kW)	TC (kW)	PI (kW)	TC (kW)	PI (kW)
46 °C		119.1	119.1	51.99	107.1	42.13	95.2	33.31	83.3	25.52	71.4	18.78	59.5	13.07	47.6	8.40	35.7	4.76
43 °C		130.6	130.6	52.96	117.5	42.91	104.5	33.92	91.4	25.99	78.3	19.12	65.3	13.30	52.2	8.55	39.2	4.85
41 °C		139.1	139.1	54.29	125.2	43.99	111.3	34.77	97.4	26.64	83.5	19.60	69.5	13.64	55.6	8.76	41.7	4.96
39 °C		143.7	143.7	52.71	129.3	42.71	115.0	33.76	100.6	25.87	86.2	19.03	71.9	13.24	57.5	8.50	43.1	4.82
37 °C		148.0	148.0	51.11	133.2	41.42	118.4	32.74	103.6	25.09	88.8	18.45	74.0	12.84	59.2	8.25	44.4	4.67
35 °C		152.0	152.0	50.57	136.8	40.12	121.6	31.72	106.4	24.30	91.2	17.87	76.0	12.44	60.8	7.99	45.6	4.53
32 °C		152.0	152.0	45.66	136.8	37.00	121.6	29.25	106.4	22.41	91.2	16.49	76.0	11.47	60.8	7.37	45.6	4.18
31 °C		152.0	152.0	42.25	136.8	34.24	121.6	27.07	106.4	20.74	91.2	15.26	76.0	10.62	60.8	6.82	45.6	3.87
30 °C		152.0	152.0	40.69	136.8	32.97	121.6	26.07	106.4	19.97	91.2	14.69	76.0	10.23	60.8	6.57	45.6	3.73
29 °C		152.0	152.0	39.21	136.8	31.77	121.6	25.12	106.4	19.25	91.2	14.16	76.0	9.85	60.8	6.33	45.6	3.59
27 °C		152.0	152.0	36.46	136.8	29.54	121.6	23.36	106.4	17.90	91.2	13.17	76.0	9.16	60.8	5.89	45.6	3.34
25 °C		152.0	152.0	33.96	136.8	27.52	121.6	21.76	106.4	16.67	91.2	12.27	76.0	8.54	60.8	5.49	45.6	3.11
23 °C		152.0	152.0	32.36	136.8	26.23	121.6	20.74	106.4	15.89	91.2	11.69	76.0	8.14	60.8	5.23	45.6	2.97
21 °C		152.0	152.0	31.61	136.8	25.61	121.6	20.25	106.4	15.52	91.2	11.42	76.0	7.95	60.8	5.11	45.6	2.90
20 °C		152.0	152.0	31.27	136.8	25.34	121.6	20.03	106.4	15.35	91.2	11.30	76.0	7.86	60.8	5.06	45.6	2.87
19 °C		152.0	152.0	30.95	136.8	25.09	121.6	19.83	106.4	15.20	91.2	11.18	76.0	7.79	60.8	5.01	45.6	2.84
17 °C		152.0	152.0	30.40	136.8	24.63	121.6	19.48	106.4	14.93	91.2	10.98	76.0	7.65	60.8	4.92	45.6	2.79
15 °C		152.0	152.0	29.92	136.8	24.24	121.6	19.17	106.4	14.69	91.2	10.81	76.0	7.53	60.8	4.84	45.6	2.75

TC : Total Capacity PI : Power Input
Indoor air temperature conditions : 27.0°C dry-bulb / 19.0°C wet bulb

Outdoor Unit Dry-Bulb (°C)		Outdoor Unit Wet-Bulb (°C)	Outdoor Unit 100% Heating Capacity (kW)	Compressor + Outdoor Fan Power consumption (kW)															
				100% Capacity		90% Capacity		80% Capacity		70% Capacity		60% Capacity		50% Capacity		40% Capacity		30% Capacity	
				TC (kW)	PI (kW)	TC (kW)	PI (kW)	TC (kW)	PI (kW)	TC (kW)	PI (kW)	TC (kW)	PI (kW)	TC (kW)	PI (kW)	TC (kW)	PI (kW)	TC (kW)	PI (kW)
15.0	13.7	171.0	171.0	41.29	153.9	35.85	136.8	30.73	119.7	25.90	102.6	21.38	85.5	17.16	68.4	13.25	51.3	9.64	
13.0	11.8	171.0	171.0	42.67	153.9	37.03	136.8	31.71	119.7	26.70	102.6	22.02	85.5	17.66	68.4	13.62	51.3	9.89	
11.0	9.8	171.0	171.0	44.23	153.9	38.35	136.8	32.81	119.7	27.61	102.6	22.74	85.5	18.21	68.4	14.02	51.3	10.17	
9.0	7.9	171.0	171.0	45.82	153.9	39.70	136.8	33.94	119.7	28.53	102.6	23.48	85.5	18.78	68.4	14.44	51.3	10.45	
7.0	6.0	171.0	171.0	47.53	153.9	41.15	136.8	35.15	119.7	29.52	102.6	24.26	85.5	19.39	68.4	14.88	51.3	10.76	
5.0	4.1	166.0	166.0	47.39	149.4	41.03	132.8	35.04	116.2	29.43	99.6	24.19	83.0	19.33	66.4	14.84	49.8	10.72	
3.0	2.2	161.0	161.0	47.24	144.9	40.90	128.8	34.93	112.7	29.34	96.6	24.12	80.5	19.27	64.4	14.79	48.3	10.69	
0.0	-0.7	153.4	153.4	47.02	138.0	40.71	122.7	34.77	107.4	29.20	92.0	24.00	76.7	19.18	61.4	14.72	46.0	10.64	
-3.0	-3.7	145.5	145.5	46.79	130.9	40.51	116.4	34.60	101.8	29.06	87.3	23.89	72.7	19.08	58.2	14.65	43.6	10.59	
-5.0	-5.6	140.5	140.5	46.65	126.4	40.39	112.4	34.49	98.3	28.97	84.3	23.81	70.2	19.03	56.2	14.61	42.1	10.56	
-7.0	-7.6	135.2	135.2	46.50	121.7	40.25	108.2	34.38	94.7	28.87	81.1	23.74	67.6	18.96	54.1	14.56	40.6	10.52	
-10	-10.5	127.6	127.6	46.28	114.8	40.06	102.1	34.22	89.3	28.74	76.6	23.62	63.8	18.87	51.0	14.49	38.3	10.47	
-14.5	-15.0	115.8	115.8	45.93	104.2	39.77	92.6	33.96	81.0	28.52	69.5	23.45	57.9	18.73	46.3	14.38	34.7	10.40	
-19.5	-20.0	102.6	102.6	45.55	92.3	39.44	82.1	33.68	71.8	28.29	61.6	23.25	51.3	18.58	41.0	14.26	30.8	10.31	

TC : Total Capacity PI : Power Input
Indoor air temperature conditions : 20.0°C dry-bulb

MMY-UP5611HT8P-E (56HP, 156.5 kW system)

Cooling			Compressor + Outdoor Fan Power consumption (kW)															
			100% Capacity		90% Capacity		80% Capacity		70% Capacity		60% Capacity		50% Capacity		40% Capacity		30% Capacity	
			TC	PI	TC	PI	TC	PI	TC	PI	TC	PI	TC	PI	TC	PI	TC	PI
Outdoor Unit Dry-Bulb (°C)	Outdoor Unit 100% Cooling Capacity (kW)	(kW)	(kW)	(kW)	(kW)	(kW)	(kW)	(kW)	(kW)	(kW)	(kW)	(kW)	(kW)	(kW)	(kW)	(kW)	(kW)	
46 °C	122.6	122.6	54.00	110.3	43.79	98.1	34.66	85.8	26.59	73.5	19.59	61.3	13.66	49.0	8.80	36.8	5.01	
43 °C	134.4	134.4	54.98	121.0	44.59	107.6	35.29	94.1	27.07	80.7	19.95	67.2	13.91	53.8	8.96	40.3	5.10	
41 °C	143.2	143.2	56.35	128.9	45.70	114.6	36.16	100.2	27.74	85.9	20.44	71.6	14.25	57.3	9.18	43.0	5.22	
39 °C	148.0	148.0	54.72	133.2	44.37	118.4	35.11	103.6	26.94	88.8	19.84	74.0	13.84	59.2	8.91	44.4	5.07	
37 °C	152.4	152.4	53.06	137.2	43.03	121.9	34.05	106.7	26.12	91.4	19.24	76.2	13.42	61.0	8.64	45.7	4.91	
35 °C	156.5	156.5	52.54	140.9	41.68	125.2	32.99	109.6	25.30	93.9	18.64	78.3	13.00	62.6	8.37	47.0	4.76	
32 °C	156.5	156.5	47.41	140.9	38.45	125.2	30.43	109.6	23.34	93.9	17.20	78.3	11.99	62.6	7.72	47.0	4.39	
31 °C	156.5	156.5	43.88	140.9	35.59	125.2	28.16	109.6	21.61	93.9	15.92	78.3	11.10	62.6	7.15	47.0	4.07	
30 °C	156.5	156.5	42.26	140.9	34.27	125.2	27.12	109.6	20.81	93.9	15.33	78.3	10.69	62.6	6.89	47.0	3.92	
29 °C	156.5	156.5	40.72	140.9	33.03	125.2	26.14	109.6	20.05	93.9	14.78	78.3	10.31	62.6	6.64	47.0	3.78	
27 °C	156.5	156.5	37.87	140.9	30.71	125.2	24.31	109.6	18.65	93.9	13.74	78.3	9.59	62.6	6.18	47.0	3.52	
25 °C	156.5	156.5	35.28	140.9	28.61	125.2	22.65	109.6	17.38	93.9	12.81	78.3	8.93	62.6	5.76	47.0	3.28	
23 °C	156.5	156.5	33.63	140.9	27.27	125.2	21.59	109.6	16.57	93.9	12.21	78.3	8.52	62.6	5.49	47.0	3.13	
21 °C	156.5	156.5	32.84	140.9	26.64	125.2	21.08	109.6	16.18	93.9	11.92	78.3	8.32	62.6	5.36	47.0	3.06	
20 °C	156.5	156.5	32.49	140.9	26.35	125.2	20.86	109.6	16.01	93.9	11.80	78.3	8.23	62.6	5.31	47.0	3.02	
19 °C	156.5	156.5	32.17	140.9	26.09	125.2	20.65	109.6	15.85	93.9	11.68	78.3	8.15	62.6	5.25	47.0	2.99	
17 °C	156.5	156.5	31.59	140.9	25.62	125.2	20.28	109.6	15.56	93.9	11.47	78.3	8.00	62.6	5.16	47.0	2.94	
15 °C	156.5	156.5	31.09	140.9	25.22	125.2	19.96	109.6	15.32	93.9	11.29	78.3	7.88	62.6	5.08	47.0	2.90	

TC : Total Capacity PI : Power Input
 Indoor air temperature conditions : 27.0°C dry-bulb / 19.0°C wet bulb

Heating			Compressor + Outdoor Fan Power consumption (kW)															
			100% Capacity		90% Capacity		80% Capacity		70% Capacity		60% Capacity		50% Capacity		40% Capacity		30% Capacity	
			TC	PI	TC	PI	TC	PI	TC	PI	TC	PI	TC	PI	TC	PI	TC	PI
Outdoor Unit Dry-Bulb (°C)	Outdoor Unit Wet-Bulb (°C)	Outdoor Unit 100% Heating Capacity (kW)	(kW)	(kW)	(kW)	(kW)	(kW)	(kW)	(kW)	(kW)	(kW)	(kW)	(kW)	(kW)	(kW)	(kW)	(kW)	(kW)
15.0	13.7	170.5	170.5	41.69	153.5	36.65	136.4	31.81	119.4	27.17	102.3	22.73	85.3	18.49	68.2	14.46	51.2	10.62
13.0	11.8	170.5	170.5	42.95	153.5	37.74	136.4	32.73	119.4	27.94	102.3	23.36	85.3	18.99	68.2	14.84	51.2	10.89
11.0	9.8	170.5	170.5	44.36	153.5	38.95	136.4	33.77	119.4	28.81	102.3	24.07	85.3	19.55	68.2	15.26	51.2	11.19
9.0	7.9	170.5	170.5	45.80	153.5	40.19	136.4	34.82	119.4	29.69	102.3	24.79	85.3	20.12	68.2	15.69	51.2	11.49
7.0	6.0	170.5	170.5	47.34	153.5	41.52	136.4	35.95	119.4	30.63	102.3	25.55	85.3	20.72	68.2	16.15	51.2	11.82
5.0	4.1	165.5	165.5	47.20	149.0	41.39	132.4	35.84	115.9	30.53	99.3	25.47	82.8	20.66	66.2	16.10	49.7	11.78
3.0	2.2	160.5	160.5	47.05	144.5	41.27	128.4	35.73	112.4	30.44	96.3	25.40	80.3	20.60	64.2	16.05	48.2	11.74
0.0	-0.7	152.9	152.9	46.83	137.6	41.08	122.3	35.56	107.0	30.30	91.8	25.28	76.5	20.50	61.2	15.97	45.9	11.69
-3.0	-3.7	145.1	145.1	46.61	130.6	40.88	116.0	35.39	101.5	30.15	87.0	25.15	72.5	20.40	58.0	15.90	43.5	11.63
-5.0	-5.6	140.1	140.1	46.46	126.1	40.75	112.1	35.28	98.1	30.06	84.0	25.08	70.0	20.34	56.0	15.85	42.0	11.60
-7.0	-7.6	134.8	134.8	46.31	121.3	40.62	107.9	35.17	94.4	29.96	80.9	24.99	67.4	20.27	53.9	15.79	40.4	11.56
-10	-10.5	127.2	127.2	46.09	114.5	40.42	101.8	35.00	89.1	29.82	76.3	24.88	63.6	20.18	50.9	15.72	38.2	11.50
-14.5	-15.0	115.4	115.4	45.75	103.9	40.13	92.3	34.74	80.8	29.60	69.2	24.69	57.7	20.03	46.2	15.60	34.6	11.42
-19.5	-20.0	102.3	102.3	45.37	92.1	39.79	81.8	34.45	71.6	29.35	61.4	24.49	51.2	19.86	40.9	15.47	30.7	11.32

TC : Total Capacity PI : Power Input
 Indoor air temperature conditions : 20.0°C dry-bulb

MMY-UP6011HT8P-E (60HP, 167.5 kW system)

Cooling		Compressor + Outdoor Fan Power consumption (kW)																	
		Outdoor Unit Dry-Bulb (°C)	Outdoor Unit 100% Cooling Capacity (kW)	100% Capacity		90% Capacity		80% Capacity		70% Capacity		60% Capacity		50% Capacity		40% Capacity		30% Capacity	
				TC (kW)	PI (kW)	TC (kW)	PI (kW)	TC (kW)	PI (kW)	TC (kW)	PI (kW)	TC (kW)	PI (kW)	TC (kW)	PI (kW)	TC (kW)	PI (kW)	TC (kW)	PI (kW)
46 °C	131.2	131.2	60.35	118.1	48.93	105.0	38.70	91.8	29.68	78.7	21.85	65.6	15.22	52.5	9.78	39.4	5.54		
43 °C	143.9	143.9	61.46	129.5	49.83	115.1	39.41	100.7	30.22	86.3	22.25	71.9	15.49	57.6	9.96	43.2	5.64		
41 °C	153.3	153.3	62.99	137.9	51.07	122.6	40.40	107.3	30.97	92.0	22.80	76.6	15.88	61.3	10.20	46.0	5.78		
39 °C	158.4	158.4	61.16	142.5	49.59	126.7	39.22	110.9	30.07	95.0	22.14	79.2	15.42	63.4	9.91	47.5	5.61		
37 °C	163.1	163.1	59.31	146.8	48.08	130.5	38.03	114.2	29.16	97.9	21.47	81.6	14.95	65.2	9.61	48.9	5.44		
35 °C	167.5	167.5	58.72	150.8	46.58	134.0	36.85	117.3	28.25	100.5	20.80	83.8	14.48	67.0	9.31	50.3	5.27		
32 °C	167.5	167.5	52.99	150.8	42.96	134.0	33.99	117.3	26.06	100.5	19.18	83.8	13.36	67.0	8.59	50.3	4.86		
31 °C	167.5	167.5	49.04	150.8	39.76	134.0	31.45	117.3	24.12	100.5	17.76	83.8	12.37	67.0	7.95	50.3	4.50		
30 °C	167.5	167.5	47.23	150.8	38.29	134.0	30.29	117.3	23.23	100.5	17.10	83.8	11.91	67.0	7.65	50.3	4.34		
29 °C	167.5	167.5	45.51	150.8	36.90	134.0	29.19	117.3	22.38	100.5	16.48	83.8	11.48	67.0	7.38	50.3	4.18		
27 °C	167.5	167.5	42.32	150.8	34.31	134.0	27.15	117.3	20.82	100.5	15.33	83.8	10.67	67.0	6.86	50.3	3.89		
25 °C	167.5	167.5	39.42	150.8	31.96	134.0	25.29	117.3	19.39	100.5	14.28	83.8	9.94	67.0	6.39	50.3	3.62		
23 °C	167.5	167.5	37.58	150.8	30.47	134.0	24.10	117.3	18.48	100.5	13.61	83.8	9.48	67.0	6.09	50.3	3.45		
21 °C	167.5	167.5	36.70	150.8	29.76	134.0	23.54	117.3	18.05	100.5	13.29	83.8	9.26	67.0	5.95	50.3	3.37		
20 °C	167.5	167.5	36.31	150.8	29.44	134.0	23.29	117.3	17.86	100.5	13.15	83.8	9.16	67.0	5.89	50.3	3.34		
19 °C	167.5	167.5	35.94	150.8	29.14	134.0	23.06	117.3	17.68	100.5	13.02	83.8	9.07	67.0	5.83	50.3	3.31		
17 °C	167.5	167.5	35.29	150.8	28.62	134.0	22.64	117.3	17.36	100.5	12.79	83.8	8.91	67.0	5.73	50.3	3.25		
15 °C	167.5	167.5	34.74	150.8	28.17	134.0	22.29	117.3	17.09	100.5	12.59	83.8	8.77	67.0	5.64	50.3	3.20		

TC : Total Capacity PI : Power Input
 Indoor air temperature conditions : 27.0°C dry-bulb / 19.0°C wet bulb

Heating		Compressor + Outdoor Fan Power consumption (kW)																		
		Outdoor Unit Dry-Bulb (°C)	Outdoor Unit Wet-Bulb (°C)	Outdoor Unit 100% Heating Capacity (kW)	100% Capacity		90% Capacity		80% Capacity		70% Capacity		60% Capacity		50% Capacity		40% Capacity		30% Capacity	
					TC (kW)	PI (kW)	TC (kW)	PI (kW)	TC (kW)	PI (kW)	TC (kW)	PI (kW)	TC (kW)	PI (kW)	TC (kW)	PI (kW)	TC (kW)	PI (kW)	TC (kW)	PI (kW)
15.0	13.7	177.5	177.5	44.82	159.8	39.73	142.0	34.77	124.3	29.95	106.5	25.26	88.8	20.71	71.0	16.30	53.3	12.02		
13.0	11.8	177.5	177.5	46.07	159.8	40.82	142.0	35.72	124.3	30.75	106.5	25.93	88.8	21.25	71.0	16.72	53.3	12.32		
11.0	9.8	177.5	177.5	47.47	159.8	42.05	142.0	36.77	124.3	31.65	106.5	26.68	88.8	21.85	71.0	17.18	53.3	12.66		
9.0	7.9	177.5	177.5	48.89	159.8	43.29	142.0	37.84	124.3	32.56	106.5	27.43	88.8	22.46	71.0	17.65	53.3	13.00		
7.0	6.0	177.5	177.5	50.41	159.8	44.61	142.0	38.99	124.3	33.53	106.5	28.23	88.8	23.11	71.0	18.15	53.3	13.36		
5.0	4.1	172.3	172.3	50.26	155.1	44.48	137.9	38.87	120.6	33.42	103.4	28.15	86.2	23.04	68.9	18.10	51.7	13.32		
3.0	2.2	167.1	167.1	50.10	150.4	44.34	133.7	38.75	117.0	33.32	100.3	28.06	83.6	22.97	66.8	18.04	50.1	13.28		
0.0	-0.7	159.2	159.2	49.87	143.3	44.14	127.4	38.57	111.4	33.17	95.5	27.93	79.6	22.86	63.7	17.96	47.8	13.22		
-3.0	-3.7	151.0	151.0	49.63	135.9	43.92	120.8	38.38	105.7	33.01	90.6	27.79	75.5	22.75	60.4	17.87	45.3	13.15		
-5.0	-5.6	145.8	145.8	49.47	131.2	43.79	116.7	38.26	102.1	32.90	87.5	27.71	72.9	22.68	58.3	17.81	43.7	13.11		
-7.0	-7.6	140.4	140.4	49.31	126.3	43.64	112.3	38.14	98.3	32.80	84.2	27.62	70.2	22.60	56.1	17.76	42.1	13.07		
-10	-10.5	132.4	132.4	49.08	119.2	43.44	106.0	37.96	92.7	32.64	79.5	27.49	66.2	22.50	53.0	17.67	39.7	13.01		
-14.5	-15.0	120.2	120.2	48.72	108.1	43.12	96.1	37.68	84.1	32.40	72.1	27.28	60.1	22.33	48.1	17.54	36.0	12.91		
-19.5	-20.0	106.5	106.5	48.31	95.9	42.76	85.2	37.36	74.6	32.13	63.9	27.06	53.3	22.15	42.6	17.40	32.0	12.81		

TC : Total Capacity PI : Power Input
 Indoor air temperature conditions : 20.0°C dry-bulb

MMY-UP6211HT8P-E (62HP, 174.0 kW system)

Cooling			Compressor + Outdoor Fan Power consumption (kW)															
			100% Capacity		90% Capacity		80% Capacity		70% Capacity		60% Capacity		50% Capacity		40% Capacity		30% Capacity	
			TC (kW)	PI (kW)	TC (kW)	PI (kW)	TC (kW)	PI (kW)	TC (kW)	PI (kW)	TC (kW)	PI (kW)	TC (kW)	PI (kW)	TC (kW)	PI (kW)	TC (kW)	PI (kW)
46 °C	136.3	136.3	64.69	122.7	52.40	109.0	41.40	95.4	31.70	81.8	23.29	68.1	16.17	54.5	10.35	40.9	5.82	
43 °C	149.5	149.5	65.90	134.5	53.38	119.6	42.17	104.6	32.29	89.7	23.72	74.7	16.47	59.8	10.54	44.8	5.93	
41 °C	159.2	159.2	67.56	143.3	54.72	127.4	43.24	111.5	33.10	95.5	24.32	79.6	16.89	63.7	10.81	47.8	6.08	
39 °C	164.5	164.5	65.60	148.1	53.13	131.6	41.98	115.2	32.14	98.7	23.61	82.3	16.40	65.8	10.50	49.4	5.90	
37 °C	169.4	169.4	63.61	152.5	51.52	135.5	40.71	118.6	31.17	101.7	22.90	84.7	15.90	67.8	10.18	50.8	5.72	
35 °C	174.0	174.0	62.93	156.6	49.91	139.2	39.44	121.8	30.19	104.4	22.18	87.0	15.41	69.6	9.86	52.2	5.55	
32 °C	174.0	174.0	56.83	156.6	46.03	139.2	36.37	121.8	27.84	104.4	20.46	87.0	14.21	69.6	9.09	52.2	5.11	
31 °C	174.0	174.0	52.58	156.6	42.59	139.2	33.65	121.8	25.76	104.4	18.93	87.0	13.14	69.6	8.41	52.2	4.73	
30 °C	174.0	174.0	50.63	156.6	41.01	139.2	32.40	121.8	24.81	104.4	18.23	87.0	12.66	69.6	8.10	52.2	4.56	
29 °C	174.0	174.0	48.78	156.6	39.51	139.2	31.22	121.8	23.90	104.4	17.56	87.0	12.20	69.6	7.81	52.2	4.39	
27 °C	174.0	174.0	45.36	156.6	36.74	139.2	29.03	121.8	22.23	104.4	16.33	87.0	11.34	69.6	7.26	52.2	4.08	
25 °C	174.0	174.0	42.25	156.6	34.22	139.2	27.04	121.8	20.70	104.4	15.21	87.0	10.56	69.6	6.76	52.2	3.80	
23 °C	174.0	174.0	40.26	156.6	32.61	139.2	25.77	121.8	19.73	104.4	14.49	87.0	10.07	69.6	6.44	52.2	3.62	
21 °C	174.0	174.0	39.32	156.6	31.85	139.2	25.16	121.8	19.27	104.4	14.15	87.0	9.83	69.6	6.29	52.2	3.54	
20 °C	174.0	174.0	38.90	156.6	31.51	139.2	24.89	121.8	19.06	104.4	14.00	87.0	9.72	69.6	6.22	52.2	3.50	
19 °C	174.0	174.0	38.51	156.6	31.19	139.2	24.64	121.8	18.87	104.4	13.86	87.0	9.63	69.6	6.16	52.2	3.47	
17 °C	174.0	174.0	37.81	156.6	30.62	139.2	24.20	121.8	18.53	104.4	13.61	87.0	9.45	69.6	6.05	52.2	3.40	
15 °C	174.0	174.0	37.21	156.6	30.14	139.2	23.82	121.8	18.23	104.4	13.40	87.0	9.30	69.6	5.95	52.2	3.35	

TC : Total Capacity PI : Power Input
Indoor air temperature conditions : 27.0°C dry-bulb / 19.0°C wet bulb

Heating			Compressor + Outdoor Fan Power consumption (kW)															
			100% Capacity		90% Capacity		80% Capacity		70% Capacity		60% Capacity		50% Capacity		40% Capacity		30% Capacity	
			TC (kW)	PI (kW)	TC (kW)	PI (kW)	TC (kW)	PI (kW)	TC (kW)	PI (kW)	TC (kW)	PI (kW)	TC (kW)	PI (kW)	TC (kW)	PI (kW)	TC (kW)	PI (kW)
15.0	13.7	185.0	185.0	47.55	166.5	42.01	148.0	36.65	129.5	31.46	111.0	26.45	92.5	21.60	74.0	16.94	55.5	12.44
13.0	11.8	185.0	185.0	48.92	166.5	43.20	148.0	37.67	129.5	32.32	111.0	27.16	92.5	22.18	74.0	17.38	55.5	12.76
11.0	9.8	185.0	185.0	50.45	166.5	44.54	148.0	38.82	129.5	33.29	111.0	27.96	92.5	22.82	74.0	17.87	55.5	13.11
9.0	7.9	185.0	185.0	52.01	166.5	45.89	148.0	39.98	129.5	34.27	111.0	28.77	92.5	23.46	74.0	18.36	55.5	13.47
7.0	6.0	185.0	185.0	53.67	166.5	47.34	148.0	41.22	129.5	35.32	111.0	29.63	92.5	24.15	74.0	18.89	55.5	13.85
5.0	4.1	179.6	179.6	53.51	161.6	47.19	143.7	41.09	125.7	35.21	107.8	29.54	89.8	24.08	71.8	18.84	53.9	13.81
3.0	2.2	174.2	174.2	53.34	156.8	47.05	139.3	40.97	121.9	35.10	104.5	29.45	87.1	24.01	69.7	18.78	52.3	13.76
0.0	-0.7	165.9	165.9	53.10	149.3	46.83	132.7	40.78	116.2	34.94	99.6	29.31	83.0	23.89	66.4	18.69	49.8	13.70
-3.0	-3.7	157.4	157.4	52.84	141.7	46.60	125.9	40.58	110.2	34.77	94.4	29.17	78.7	23.78	63.0	18.60	47.2	13.63
-5.0	-5.6	152.0	152.0	52.67	136.8	46.46	121.6	40.45	106.4	34.66	91.2	29.08	76.0	23.70	60.8	18.54	45.6	13.59
-7.0	-7.6	146.3	146.3	52.50	131.7	46.31	117.0	40.32	102.4	34.55	87.8	28.98	73.1	23.63	58.5	18.48	43.9	13.55
-10	-10.5	138.0	138.0	52.25	124.2	46.09	110.4	40.13	96.6	34.38	82.8	28.85	69.0	23.52	55.2	18.39	41.4	13.48
-14.5	-15.0	125.2	125.2	51.87	112.7	45.75	100.2	39.84	87.7	34.13	75.1	28.63	62.6	23.34	50.1	18.26	37.6	13.38
-19.5	-20.0	111.0	111.0	51.44	99.9	45.37	88.8	39.51	77.7	33.85	66.6	28.40	55.5	23.15	44.4	18.11	33.3	13.27

TC : Total Capacity PI : Power Input
Indoor air temperature conditions : 20.0°C dry-bulb

MMY-UP6411HT8P-E (64HP, 179.0 kW system)

Outdoor Unit Dry-Bulb (°C)		Outdoor Unit 100% Cooling Capacity (kW)	Compressor + Outdoor Fan Power consumption (kW)															
			100% Capacity		90% Capacity		80% Capacity		70% Capacity		60% Capacity		50% Capacity		40% Capacity		30% Capacity	
			TC (kW)	PI (kW)	TC (kW)	PI (kW)	TC (kW)	PI (kW)	TC (kW)	PI (kW)	TC (kW)	PI (kW)	TC (kW)	PI (kW)	TC (kW)	PI (kW)	TC (kW)	PI (kW)
46 °C		140.2	140.2	61.91	126.2	50.16	112.2	39.65	98.1	30.38	84.1	22.34	70.1	15.54	56.1	9.98	42.1	5.65
43 °C		153.8	153.8	63.05	138.4	51.09	123.0	40.39	107.6	30.94	92.3	22.76	76.9	15.83	61.5	10.16	46.1	5.75
41 °C		163.8	163.8	64.64	147.4	52.37	131.0	41.40	114.7	31.72	98.3	23.32	81.9	16.22	65.5	10.41	49.1	5.89
39 °C		169.3	169.3	62.76	152.3	50.85	135.4	40.20	118.5	30.79	101.6	22.65	84.6	15.75	67.7	10.11	50.8	5.72
37 °C		174.3	174.3	60.86	156.9	49.31	139.4	38.98	122.0	29.86	104.6	21.96	87.2	15.27	69.7	9.80	52.3	5.55
35 °C		179.0	179.0	60.21	161.1	47.77	143.2	37.76	125.3	28.93	107.4	21.27	89.5	14.80	71.6	9.50	53.7	5.38
32 °C		179.0	179.0	54.37	161.1	44.06	143.2	34.83	125.3	26.68	107.4	19.62	89.5	13.65	71.6	8.76	53.7	4.96
31 °C		179.0	179.0	50.31	161.1	40.77	143.2	32.23	125.3	24.69	107.4	18.16	89.5	12.63	71.6	8.11	53.7	4.59
30 °C		179.0	179.0	48.45	161.1	39.26	143.2	31.03	125.3	23.78	107.4	17.49	89.5	12.17	71.6	7.81	53.7	4.42
29 °C		179.0	179.0	46.68	161.1	37.83	143.2	29.90	125.3	22.91	107.4	16.85	89.5	11.72	71.6	7.53	53.7	4.26
27 °C		179.0	179.0	43.41	161.1	35.17	143.2	27.81	125.3	21.30	107.4	15.67	89.5	10.90	71.6	7.00	53.7	3.97
25 °C		179.0	179.0	40.43	161.1	32.76	143.2	25.90	125.3	19.84	107.4	14.60	89.5	10.16	71.6	6.52	53.7	3.70
23 °C		179.0	179.0	38.53	161.1	31.22	143.2	24.68	125.3	18.91	107.4	13.91	89.5	9.68	71.6	6.22	53.7	3.53
21 °C		179.0	179.0	37.63	161.1	30.49	143.2	24.11	125.3	18.47	107.4	13.59	89.5	9.46	71.6	6.07	53.7	3.44
20 °C		179.0	179.0	37.23	161.1	30.17	143.2	23.85	125.3	18.27	107.4	13.44	89.5	9.35	71.6	6.01	53.7	3.41
19 °C		179.0	179.0	36.86	161.1	29.86	143.2	23.61	125.3	18.09	107.4	13.31	89.5	9.26	71.6	5.95	53.7	3.37
17 °C		179.0	179.0	36.19	161.1	29.32	143.2	23.18	125.3	17.76	107.4	13.07	89.5	9.09	71.6	5.84	53.7	3.31
15 °C		179.0	179.0	35.62	161.1	28.86	143.2	22.82	125.3	17.49	107.4	12.86	89.5	8.95	71.6	5.75	53.7	3.26

TC : Total Capacity PI : Power Input
Indoor air temperature conditions : 27.0°C dry-bulb / 19.0°C wet bulb

Outdoor Unit Dry-Bulb (°C)		Wet-Bulb (°C)	Outdoor Unit 100% Heating Capacity (kW)	Compressor + Outdoor Fan Power consumption (kW)															
				100% Capacity		90% Capacity		80% Capacity		70% Capacity		60% Capacity		50% Capacity		40% Capacity		30% Capacity	
				TC (kW)	PI (kW)	TC (kW)	PI (kW)	TC (kW)	PI (kW)	TC (kW)	PI (kW)	TC (kW)	PI (kW)	TC (kW)	PI (kW)	TC (kW)	PI (kW)	TC (kW)	PI (kW)
15.0	13.7	196.0	196.0	49.30	176.4	43.22	156.8	37.40	137.2	31.86	117.6	26.59	98.0	21.58	78.4	16.85	58.8	12.39	
13.0	11.8	196.0	196.0	50.83	176.4	44.53	156.8	38.51	137.2	32.78	117.6	27.33	98.0	22.17	78.4	17.30	58.8	12.70	
11.0	9.8	196.0	196.0	52.55	176.4	46.00	156.8	39.76	137.2	33.82	117.6	28.17	98.0	22.83	78.4	17.79	58.8	13.05	
9.0	7.9	196.0	196.0	54.30	176.4	47.50	156.8	41.03	137.2	34.87	117.6	29.03	98.0	23.50	78.4	18.29	58.8	13.40	
7.0	6.0	196.0	196.0	56.17	176.4	49.11	156.8	42.38	137.2	35.99	117.6	29.94	98.0	24.22	78.4	18.83	58.8	13.78	
5.0	4.1	190.3	190.3	56.00	171.2	48.96	152.2	42.26	133.2	35.88	114.2	29.85	95.1	24.14	76.1	18.77	57.1	13.74	
3.0	2.2	184.5	184.5	55.83	166.1	48.81	147.6	42.13	129.2	35.77	110.7	29.76	92.3	24.07	73.8	18.72	55.4	13.69	
0.0	-0.7	175.8	175.8	55.57	158.2	48.58	140.6	41.93	123.1	35.61	105.5	29.62	87.9	23.96	70.3	18.63	52.7	13.63	
-3.0	-3.7	166.8	166.8	55.30	150.1	48.35	133.4	41.73	116.7	35.43	100.1	29.47	83.4	23.84	66.7	18.54	50.0	13.56	
-5.0	-5.6	161.0	161.0	55.13	144.9	48.20	128.8	41.60	112.7	35.33	96.6	29.38	80.5	23.77	64.4	18.48	48.3	13.52	
-7.0	-7.6	155.0	155.0	54.95	139.5	48.04	124.0	41.46	108.5	35.21	93.0	29.29	77.5	23.69	62.0	18.42	46.5	13.48	
-10	-10.5	146.2	146.2	54.69	131.6	47.81	117.0	41.27	102.4	35.04	87.7	29.15	73.1	23.58	58.5	18.33	43.9	13.41	
-14.5	-15.0	132.7	132.7	54.28	119.4	47.46	106.1	40.96	92.9	34.78	79.6	28.93	66.3	23.40	53.1	18.20	39.8	13.32	
-19.5	-20.0	117.6	117.6	53.83	105.8	47.07	94.1	40.62	82.3	34.50	70.6	28.69	58.8	23.21	47.0	18.05	35.3	13.21	

TC : Total Capacity PI : Power Input
Indoor air temperature conditions : 20.0°C dry-bulb

MMY-UP6611HT8P-E(66HP, 184.5 kW system)

Cooling		Compressor + Outdoor Fan Power consumption (kW)																	
		Outdoor Unit 100% Cooling Capacity (kW)		100% Capacity		90% Capacity		80% Capacity		70% Capacity		60% Capacity		50% Capacity		40% Capacity		30% Capacity	
		TC	PI	TC	PI	TC	PI	TC	PI	TC	PI	TC	PI	TC	PI	TC	PI	TC	PI
46 °C		144.5	144.5	64.40	130.1	52.20	115.6	41.28	101.2	31.64	86.7	23.29	72.3	16.23	57.8	10.44	43.4	5.95	
43 °C		158.5	158.5	65.59	142.6	53.16	126.8	42.04	110.9	32.22	95.1	23.72	79.2	16.52	63.4	10.63	47.5	6.05	
41 °C		168.8	168.8	67.24	151.9	54.49	135.1	43.09	118.2	33.02	101.3	24.30	84.4	16.93	67.5	10.89	50.6	6.19	
39 °C		174.5	174.5	65.28	157.0	52.91	139.6	41.83	122.1	32.07	104.7	23.60	87.2	16.43	69.8	10.57	52.3	6.01	
37 °C		179.7	179.7	63.30	161.7	51.30	143.7	40.57	125.8	31.09	107.8	22.88	89.8	15.94	71.9	10.25	53.9	5.83	
35 °C		184.5	184.5	62.63	166.1	49.70	147.6	39.30	129.2	30.12	110.7	22.17	92.3	15.44	73.8	9.93	55.4	5.65	
32 °C		184.5	184.5	56.56	166.1	45.84	147.6	36.25	129.2	27.78	110.7	20.45	92.3	14.24	73.8	9.17	55.4	5.22	
31 °C		184.5	184.5	52.34	166.1	42.42	147.6	33.54	129.2	25.71	110.7	18.93	92.3	13.18	73.8	8.49	55.4	4.83	
30 °C		184.5	184.5	50.40	166.1	40.85	147.6	32.30	129.2	24.76	110.7	18.23	92.3	12.70	73.8	8.17	55.4	4.65	
29 °C		184.5	184.5	48.56	166.1	39.36	147.6	31.13	129.2	23.86	110.7	17.56	92.3	12.24	73.8	7.88	55.4	4.49	
27 °C		184.5	184.5	45.16	166.1	36.60	147.6	28.95	129.2	22.19	110.7	16.34	92.3	11.38	73.8	7.33	55.4	4.18	
25 °C		184.5	184.5	42.06	166.1	34.09	147.6	26.96	129.2	20.67	110.7	15.22	92.3	10.60	73.8	6.83	55.4	3.89	
23 °C		184.5	184.5	40.09	166.1	32.50	147.6	25.70	129.2	19.70	110.7	14.51	92.3	10.11	73.8	6.51	55.4	3.71	
21 °C		184.5	184.5	39.15	166.1	31.74	147.6	25.10	129.2	19.24	110.7	14.17	92.3	9.88	73.8	6.36	55.4	3.63	
20 °C		184.5	184.5	38.74	166.1	31.40	147.6	24.83	129.2	19.04	110.7	14.02	92.3	9.77	73.8	6.29	55.4	3.59	
19 °C		184.5	184.5	38.35	166.1	31.08	147.6	24.58	129.2	18.85	110.7	13.88	92.3	9.67	73.8	6.23	55.4	3.56	
17 °C		184.5	184.5	37.65	166.1	30.52	147.6	24.14	129.2	18.51	110.7	13.63	92.3	9.50	73.8	6.12	55.4	3.49	
15 °C		184.5	184.5	37.06	166.1	30.04	147.6	23.76	129.2	18.22	110.7	13.42	92.3	9.35	73.8	6.03	55.4	3.44	

TC : Total Capacity PI : Power Input
Indoor air temperature conditions : 27.0°C dry-bulb / 19.0°C wet bulb

Heating		Compressor + Outdoor Fan Power consumption (kW)																	
		Outdoor Unit 100% Heating Capacity (kW)		100% Capacity		90% Capacity		80% Capacity		70% Capacity		60% Capacity		50% Capacity		40% Capacity		30% Capacity	
		TC	PI	TC	PI	TC	PI	TC	PI	TC	PI	TC	PI	TC	PI	TC	PI	TC	PI
15.0	13.7	202.0	202.0	50.61	181.8	44.49	161.6	38.60	141.4	32.97	121.2	27.57	101.0	22.42	80.8	17.51	60.6	12.85	
13.0	11.8	202.0	202.0	52.14	181.8	45.81	161.6	39.73	141.4	33.90	121.2	28.34	101.0	23.03	80.8	17.97	60.6	13.17	
11.0	9.8	202.0	202.0	53.86	181.8	47.29	161.6	40.99	141.4	34.96	121.2	29.20	101.0	23.71	80.8	18.49	60.6	13.54	
9.0	7.9	202.0	202.0	55.61	181.8	48.80	161.6	42.27	141.4	36.03	121.2	30.07	101.0	24.40	80.8	19.01	60.6	13.91	
7.0	6.0	202.0	202.0	57.48	181.8	50.41	161.6	43.64	141.4	37.17	121.2	31.00	101.0	25.13	80.8	19.57	60.6	14.30	
5.0	4.1	196.1	196.1	57.31	176.5	50.25	156.9	43.50	137.3	37.05	117.7	30.90	98.0	25.05	78.4	19.51	58.8	14.26	
3.0	2.2	190.2	190.2	57.13	171.2	50.10	152.2	43.37	133.1	36.94	114.1	30.81	95.1	24.98	76.1	19.45	57.1	14.21	
0.0	-0.7	181.2	181.2	56.86	163.1	49.87	144.9	43.17	126.8	36.77	108.7	30.67	90.6	24.86	72.5	19.36	54.4	14.15	
-3.0	-3.7	171.9	171.9	56.59	154.7	49.63	137.5	42.96	120.3	36.59	103.1	30.52	85.9	24.74	68.7	19.26	51.6	14.08	
-5.0	-5.6	166.0	166.0	56.41	149.4	49.47	132.8	42.83	116.2	36.48	99.6	30.42	83.0	24.66	66.4	19.20	49.8	14.04	
-7.0	-7.6	159.7	159.7	56.23	143.8	49.31	127.8	42.69	111.8	36.36	95.8	30.32	79.9	24.58	63.9	19.14	47.9	13.99	
-10	-10.5	150.7	150.7	55.96	135.7	49.08	120.6	42.48	105.5	36.19	90.4	30.18	75.4	24.47	60.3	19.05	45.2	13.92	
-14.5	-15.0	136.7	136.7	55.55	123.1	48.71	109.4	42.17	95.7	35.92	82.0	29.96	68.4	24.29	54.7	18.91	41.0	13.82	
-19.5	-20.0	121.2	121.2	55.09	109.1	48.31	97.0	41.82	84.8	35.62	72.7	29.71	60.6	24.09	48.5	18.75	36.4	13.71	

TC : Total Capacity PI : Power Input
Indoor air temperature conditions : 20.0°C dry-bulb

MMY-UP6811HT8P-E (38HP, 190.0 kW system)

Outdoor Unit Dry-Bulb (°C)		Outdoor Unit 100% Cooling Capacity (kW)	Compressor + Outdoor Fan Power consumption (kW)															
			100% Capacity		90% Capacity		80% Capacity		70% Capacity		60% Capacity		50% Capacity		40% Capacity		30% Capacity	
			TC (kW)	PI (kW)	TC (kW)	PI (kW)	TC (kW)	PI (kW)	TC (kW)	PI (kW)	TC (kW)	PI (kW)	TC (kW)	PI (kW)	TC (kW)	PI (kW)	TC (kW)	PI (kW)
46 °C		148.8	148.8	68.26	133.9	55.30	119.1	43.70	104.2	33.47	89.3	24.60	74.4	17.10	59.5	10.96	44.6	6.18
43 °C		163.2	163.2	69.53	146.9	56.32	130.6	44.51	114.3	34.09	97.9	25.06	81.6	17.41	65.3	11.16	49.0	6.30
41 °C		173.9	173.9	71.28	156.5	57.74	139.1	45.63	121.7	34.95	104.3	25.69	86.9	17.85	69.5	11.44	52.2	6.45
39 °C		179.7	179.7	69.20	161.7	56.06	143.7	44.31	125.8	33.93	107.8	24.94	89.8	17.33	71.9	11.11	53.9	6.27
37 °C		185.0	185.0	67.11	166.5	54.37	148.0	42.96	129.5	32.90	111.0	24.18	92.5	16.81	74.0	10.77	55.5	6.08
35 °C		190.0	190.0	66.39	171.0	52.67	152.0	41.62	133.0	31.87	114.0	23.43	95.0	16.28	76.0	10.43	57.0	5.89
32 °C		190.0	190.0	59.95	171.0	48.57	152.0	38.38	133.0	29.40	114.0	21.61	95.0	15.02	76.0	9.62	57.0	5.43
31 °C		190.0	190.0	55.47	171.0	44.94	152.0	35.52	133.0	27.20	114.0	19.99	95.0	13.90	76.0	8.91	57.0	5.03
30 °C		190.0	190.0	53.42	171.0	43.28	152.0	34.20	133.0	26.19	114.0	19.25	95.0	13.38	76.0	8.58	57.0	4.84
29 °C		190.0	190.0	51.47	171.0	41.70	152.0	32.95	133.0	25.24	114.0	18.55	95.0	12.89	76.0	8.26	57.0	4.66
27 °C		190.0	190.0	47.86	171.0	38.77	152.0	30.64	133.0	23.47	114.0	17.25	95.0	11.99	76.0	7.69	57.0	4.34
25 °C		190.0	190.0	44.58	171.0	36.11	152.0	28.54	133.0	21.86	114.0	16.07	95.0	11.17	76.0	7.16	57.0	4.04
23 °C		190.0	190.0	42.48	171.0	34.42	152.0	27.20	133.0	20.83	114.0	15.31	95.0	10.64	76.0	6.82	57.0	3.85
21 °C		190.0	190.0	41.49	171.0	33.61	152.0	26.56	133.0	20.34	114.0	14.96	95.0	10.40	76.0	6.66	57.0	3.76
20 °C		190.0	190.0	41.04	171.0	33.25	152.0	26.28	133.0	20.13	114.0	14.80	95.0	10.28	76.0	6.59	57.0	3.72
19 °C		190.0	190.0	40.63	171.0	32.92	152.0	26.01	133.0	19.92	114.0	14.65	95.0	10.18	76.0	6.53	57.0	3.69
17 °C		190.0	190.0	39.90	171.0	32.32	152.0	25.54	133.0	19.56	114.0	14.38	95.0	10.00	76.0	6.41	57.0	3.62
15 °C		190.0	190.0	39.27	171.0	31.81	152.0	25.14	133.0	19.26	114.0	14.16	95.0	9.84	76.0	6.31	57.0	3.56

TC : Total Capacity PI : Power Input
Indoor air temperature conditions : 27.0°C dry-bulb / 19.0°C wet bulb

Outdoor Unit Dry-Bulb (°C)		Wet-Bulb (°C)	Outdoor Unit 100% Heating Capacity (kW)	Compressor + Outdoor Fan Power consumption (kW)															
				100% Capacity		90% Capacity		80% Capacity		70% Capacity		60% Capacity		50% Capacity		40% Capacity		30% Capacity	
				TC (kW)	PI (kW)	TC (kW)	PI (kW)	TC (kW)	PI (kW)	TC (kW)	PI (kW)	TC (kW)	PI (kW)	TC (kW)	PI (kW)	TC (kW)	PI (kW)	TC (kW)	PI (kW)
15.0	13.7	203.0	203.0	52.43	182.7	46.30	162.4	40.36	142.1	34.64	121.8	29.12	101.5	23.80	81.2	18.70	60.9	13.79	
13.0	11.8	203.0	203.0	53.95	182.7	47.62	162.4	41.50	142.1	35.59	121.8	29.90	101.5	24.43	81.2	19.18	60.9	14.14	
11.0	9.8	203.0	203.0	55.66	182.7	49.10	162.4	42.76	142.1	36.66	121.8	30.78	101.5	25.13	81.2	19.71	60.9	14.52	
9.0	7.9	203.0	203.0	57.39	182.7	50.60	162.4	44.05	142.1	37.74	121.8	31.67	101.5	25.84	81.2	20.26	60.9	14.91	
7.0	6.0	203.0	203.0	59.24	182.7	52.20	162.4	45.42	142.1	38.89	121.8	32.62	101.5	26.60	81.2	20.83	60.9	15.32	
5.0	4.1	197.1	197.1	59.06	177.4	52.05	157.7	45.28	137.9	38.78	118.2	32.52	98.5	26.52	78.8	20.77	59.1	15.28	
3.0	2.2	191.1	191.1	58.88	172.0	51.89	152.9	45.15	133.8	38.66	114.7	32.42	95.6	26.44	76.5	20.71	57.3	15.23	
0.0	-0.7	182.1	182.1	58.61	163.9	51.64	145.7	44.93	127.5	38.48	109.2	32.27	91.0	26.31	72.8	20.61	54.6	15.16	
-3.0	-3.7	172.7	172.7	58.32	155.4	51.39	138.2	44.72	120.9	38.29	103.6	32.11	86.4	26.19	69.1	20.51	51.8	15.09	
-5.0	-5.6	166.8	166.8	58.14	150.1	51.24	133.4	44.58	116.7	38.17	100.1	32.01	83.4	26.11	66.7	20.45	50.0	15.04	
-7.0	-7.6	160.5	160.5	57.95	144.5	51.07	128.4	44.43	112.4	38.05	96.3	31.91	80.3	26.02	64.2	20.38	48.2	14.99	
-10	-10.5	151.5	151.5	57.68	136.3	50.83	121.2	44.22	106.0	37.87	90.9	31.76	75.7	25.90	60.6	20.28	45.4	14.92	
-14.5	-15.0	137.4	137.4	57.25	123.7	50.45	109.9	43.90	96.2	37.59	82.4	31.52	68.7	25.71	55.0	20.13	41.2	14.81	
-19.5	-20.0	121.8	121.8	56.78	109.6	50.03	97.4	43.53	85.3	37.28	73.1	31.26	60.9	25.49	48.7	19.97	36.5	14.69	

TC : Total Capacity PI : Power Input
Indoor air temperature conditions : 20.0°C dry-bulb

MMY-UP7011HT8P-E (70HP, 195.5 kW system)

Outdoor Unit Dry-Bulb (°C)		Outdoor Unit 100% Cooling Capacity (kW)	Compressor + Outdoor Fan Power consumption (kW)															
			100% Capacity		90% Capacity		80% Capacity		70% Capacity		60% Capacity		50% Capacity		40% Capacity		30% Capacity	
			TC (kW)	PI (kW)	TC (kW)	PI (kW)	TC (kW)	PI (kW)	TC (kW)	PI (kW)	TC (kW)	PI (kW)	TC (kW)	PI (kW)	TC (kW)	PI (kW)	TC (kW)	PI (kW)
46 °C		153.1	153.1	70.75	137.8	57.33	122.5	45.32	107.2	34.73	91.9	25.55	76.6	17.78	61.3	11.42	45.9	6.48
43 °C		167.9	167.9	72.06	151.2	58.39	134.4	46.16	117.6	35.37	100.8	26.02	84.0	18.10	67.2	11.63	50.4	6.59
41 °C		178.9	178.9	73.87	161.0	59.86	143.1	47.32	125.2	36.26	107.3	26.67	89.4	18.55	71.6	11.91	53.7	6.75
39 °C		184.9	184.9	71.73	166.4	58.12	147.9	45.94	129.4	35.20	110.9	25.89	92.4	18.01	73.9	11.57	55.5	6.56
37 °C		190.4	190.4	69.55	171.3	56.36	152.3	44.55	133.3	34.14	114.2	25.11	95.2	17.47	76.1	11.22	57.1	6.36
35 °C		195.5	195.5	68.81	176.0	54.60	156.4	43.16	136.9	33.07	117.3	24.32	97.8	16.92	78.2	10.87	58.7	6.16
32 °C		195.5	195.5	62.14	176.0	50.35	156.4	39.81	136.9	30.50	117.3	22.43	97.8	15.61	78.2	10.03	58.7	5.68
31 °C		195.5	195.5	57.50	176.0	46.59	156.4	36.83	136.9	28.22	117.3	20.76	97.8	14.45	78.2	9.28	58.7	5.26
30 °C		195.5	195.5	55.37	176.0	44.87	156.4	35.47	136.9	27.18	117.3	19.99	97.8	13.91	78.2	8.94	58.7	5.07
29 °C		195.5	195.5	53.35	176.0	43.23	156.4	34.18	136.9	26.19	117.3	19.27	97.8	13.41	78.2	8.61	58.7	4.89
27 °C		195.5	195.5	49.61	176.0	40.20	156.4	31.78	136.9	24.35	117.3	17.92	97.8	12.47	78.2	8.01	58.7	4.55
25 °C		195.5	195.5	46.21	176.0	37.45	156.4	29.60	136.9	22.69	117.3	16.69	97.8	11.62	78.2	7.47	58.7	4.24
23 °C		195.5	195.5	44.04	176.0	35.69	156.4	28.22	136.9	21.62	117.3	15.91	97.8	11.07	78.2	7.12	58.7	4.04
21 °C		195.5	195.5	43.01	176.0	34.85	156.4	27.56	136.9	21.12	117.3	15.54	97.8	10.82	78.2	6.95	58.7	3.95
20 °C		195.5	195.5	42.55	176.0	34.48	156.4	27.26	136.9	20.89	117.3	15.37	97.8	10.70	78.2	6.88	58.7	3.91
19 °C		195.5	195.5	42.12	176.0	34.14	156.4	26.99	136.9	20.68	117.3	15.22	97.8	10.59	78.2	6.81	58.7	3.87
17 °C		195.5	195.5	41.36	176.0	33.52	156.4	26.50	136.9	20.31	117.3	14.94	97.8	10.40	78.2	6.69	58.7	3.80
15 °C		195.5	195.5	40.71	176.0	32.99	156.4	26.09	136.9	19.99	117.3	14.71	97.8	10.24	78.2	6.58	58.7	3.74

TC : Total Capacity PI : Power Input
Indoor air temperature conditions : 27.0°C dry-bulb / 19.0°C wet bulb

Outdoor Unit Dry-Bulb (°C)		Outdoor Unit Wet-Bulb (°C)	Outdoor Unit 100% Heating Capacity (kW)	Compressor + Outdoor Fan Power consumption (kW)															
				100% Capacity		90% Capacity		80% Capacity		70% Capacity		60% Capacity		50% Capacity		40% Capacity		30% Capacity	
				TC (kW)	PI (kW)	TC (kW)	PI (kW)	TC (kW)	PI (kW)	TC (kW)	PI (kW)	TC (kW)	PI (kW)	TC (kW)	PI (kW)	TC (kW)	PI (kW)	TC (kW)	PI (kW)
15.0	13.7	209.0	209.0	53.75	188.1	47.57	167.2	41.57	146.3	35.75	125.4	30.10	104.5	24.64	83.6	19.35	62.7	14.25	
13.0	11.8	209.0	209.0	55.27	188.1	48.90	167.2	42.71	146.3	36.71	125.4	30.91	104.5	25.29	83.6	19.85	62.7	14.61	
11.0	9.8	209.0	209.0	56.97	188.1	50.38	167.2	43.99	146.3	37.80	125.4	31.80	104.5	26.01	83.6	20.41	62.7	15.01	
9.0	7.9	209.0	209.0	58.70	188.1	51.89	167.2	45.29	146.3	38.90	125.4	32.71	104.5	26.74	83.6	20.97	62.7	15.42	
7.0	6.0	209.0	209.0	60.55	188.1	53.50	167.2	46.67	146.3	40.07	125.4	33.68	104.5	27.51	83.6	21.57	62.7	15.85	
5.0	4.1	202.9	202.9	60.37	182.6	53.34	162.3	46.53	142.0	39.94	121.7	33.58	101.4	27.43	81.2	21.50	60.9	15.80	
3.0	2.2	196.8	196.8	60.18	177.1	53.18	157.4	46.39	137.7	39.82	118.1	33.48	98.4	27.35	78.7	21.44	59.0	15.75	
0.0	-0.7	187.5	187.5	59.90	168.7	52.93	150.0	46.17	131.2	39.64	112.5	33.32	93.7	27.22	75.0	21.34	56.2	15.68	
-3.0	-3.7	177.8	177.8	59.61	160.0	52.67	142.2	45.95	124.5	39.44	106.7	33.16	88.9	27.09	71.1	21.24	53.3	15.60	
-5.0	-5.6	171.7	171.7	59.43	154.5	52.51	137.4	45.81	120.2	39.32	103.0	33.06	85.9	27.00	68.7	21.17	51.5	15.55	
-7.0	-7.6	165.3	165.3	59.23	148.7	52.34	132.2	45.66	115.7	39.19	99.2	32.95	82.6	26.92	66.1	21.10	49.6	15.50	
-10	-10.5	155.9	155.9	58.95	140.4	52.09	124.8	45.44	109.2	39.01	93.6	32.79	78.0	26.79	62.4	21.00	46.8	15.43	
-14.5	-15.0	141.5	141.5	58.52	127.3	51.70	113.2	45.11	99.0	38.72	84.9	32.55	70.7	26.59	56.6	20.85	42.4	15.31	
-19.5	-20.0	125.4	125.4	58.03	112.9	51.28	100.3	44.73	87.8	38.40	75.2	32.28	62.7	26.37	50.2	20.67	37.6	15.19	

TC : Total Capacity PI : Power Input
Indoor air temperature conditions : 20.0°C dry-bulb

MMY-UP7211HT8P-E (72HP, 201.0 kW system)

Cooling

Outdoor Unit Dry-Bulb (°C)	Outdoor Unit 100% Cooling Capacity (kW)	Compressor + Outdoor Fan Power consumption (kW)															
		100% Capacity		90% Capacity		80% Capacity		70% Capacity		60% Capacity		50% Capacity		40% Capacity		30% Capacity	
		TC (kW)	PI (kW)	TC (kW)	PI (kW)	TC (kW)	PI (kW)	TC (kW)	PI (kW)	TC (kW)	PI (kW)	TC (kW)	PI (kW)	TC (kW)	PI (kW)	TC (kW)	PI (kW)
46 °C	157.4	157.4	74.61	141.7	60.43	125.9	47.75	110.2	36.56	94.5	26.86	78.7	18.65	63.0	11.94	47.2	6.71
43 °C	172.7	172.7	76.00	155.4	61.56	138.1	48.64	120.9	37.24	103.6	27.36	86.3	19.00	69.1	12.16	51.8	6.84
41 °C	183.9	183.9	77.91	165.5	63.11	147.1	49.86	128.7	38.18	110.4	28.05	92.0	19.48	73.6	12.47	55.2	7.01
39 °C	190.1	190.1	75.65	171.0	61.28	152.0	48.42	133.0	37.07	114.0	27.23	95.0	18.91	76.0	12.10	57.0	6.81
37 °C	195.7	195.7	73.36	176.2	59.42	156.6	46.95	137.0	35.94	117.4	26.41	97.9	18.34	78.3	11.74	58.7	6.60
35 °C	201.0	201.0	72.57	180.9	57.56	160.8	45.48	140.7	34.82	120.6	25.58	100.5	17.77	80.4	11.37	60.3	6.40
32 °C	201.0	201.0	65.53	180.9	53.08	160.8	41.94	140.7	32.11	120.6	23.59	100.5	16.38	80.4	10.49	60.3	5.90
31 °C	201.0	201.0	60.64	180.9	49.12	160.8	38.81	140.7	29.71	120.6	21.83	100.5	15.16	80.4	9.70	60.3	5.46
30 °C	201.0	201.0	58.39	180.9	47.29	160.8	37.37	140.7	28.61	120.6	21.02	100.5	14.60	80.4	9.34	60.3	5.25
29 °C	201.0	201.0	56.26	180.9	45.57	160.8	36.00	140.7	27.57	120.6	20.25	100.5	14.06	80.4	9.00	60.3	5.06
27 °C	201.0	201.0	52.31	180.9	42.37	160.8	33.48	140.7	25.63	120.6	18.83	100.5	13.08	80.4	8.37	60.3	4.71
25 °C	201.0	201.0	48.72	180.9	39.46	160.8	31.18	140.7	23.87	120.6	17.54	100.5	12.18	80.4	7.80	60.3	4.38
23 °C	201.0	201.0	46.43	180.9	37.61	160.8	29.72	140.7	22.75	120.6	16.72	100.5	11.61	80.4	7.43	60.3	4.18
21 °C	201.0	201.0	45.34	180.9	36.73	160.8	29.02	140.7	22.22	120.6	16.32	100.5	11.34	80.4	7.25	60.3	4.08
20 °C	201.0	201.0	44.86	180.9	36.33	160.8	28.71	140.7	21.98	120.6	16.15	100.5	11.21	80.4	7.18	60.3	4.04
19 °C	201.0	201.0	44.41	180.9	35.97	160.8	28.42	140.7	21.76	120.6	15.99	100.5	11.10	80.4	7.10	60.3	4.00
17 °C	201.0	201.0	43.60	180.9	35.32	160.8	27.90	140.7	21.36	120.6	15.70	100.5	10.90	80.4	6.98	60.3	3.92
15 °C	201.0	201.0	42.91	180.9	34.76	160.8	27.47	140.7	21.03	120.6	15.45	100.5	10.73	80.4	6.87	60.3	3.86

TC : Total Capacity PI : Power Input
 Indoor air temperature conditions : 27.0°C dry-bulb / 19.0°C wet bulb

Heating

Outdoor Unit Dry-Bulb (°C)	Outdoor Unit Wet-Bulb (°C)	Outdoor Unit 100% Heating Capacity (kW)	Compressor + Outdoor Fan Power consumption (kW)															
			100% Capacity		90% Capacity		80% Capacity		70% Capacity		60% Capacity		50% Capacity		40% Capacity		30% Capacity	
			TC (kW)	PI (kW)	TC (kW)	PI (kW)	TC (kW)	PI (kW)	TC (kW)	PI (kW)	TC (kW)	PI (kW)	TC (kW)	PI (kW)	TC (kW)	PI (kW)	TC (kW)	PI (kW)
15.0	13.7	210.0	210.0	55.56	189.0	49.38	168.0	43.33	147.0	37.42	126.0	31.65	105.0	26.02	84.0	20.54	63.0	15.19
13.0	11.8	210.0	210.0	57.08	189.0	50.70	168.0	44.48	147.0	38.40	126.0	32.47	105.0	26.69	84.0	21.06	63.0	15.57
11.0	9.8	210.0	210.0	58.77	189.0	52.19	168.0	45.77	147.0	39.50	126.0	33.39	105.0	27.44	84.0	21.64	63.0	15.99
9.0	7.9	210.0	210.0	60.48	189.0	53.70	168.0	47.07	147.0	40.61	126.0	34.32	105.0	28.19	84.0	22.22	63.0	16.42
7.0	6.0	210.0	210.0	62.31	189.0	55.30	168.0	48.46	147.0	41.79	126.0	35.30	105.0	28.98	84.0	22.84	63.0	16.87
5.0	4.1	203.9	203.9	62.12	183.5	55.13	163.1	48.31	142.7	41.67	122.3	35.19	101.9	28.90	81.5	22.77	61.2	16.82
3.0	2.2	197.7	197.7	61.93	178.0	54.96	158.2	48.16	138.4	41.54	118.6	35.09	98.9	28.81	79.1	22.70	59.3	16.77
0.0	-0.7	188.4	188.4	61.64	169.5	54.71	150.7	47.94	131.8	41.35	113.0	34.92	94.2	28.67	75.3	22.59	56.5	16.69
-3.0	-3.7	178.7	178.7	61.34	160.8	54.44	142.9	47.71	125.1	41.14	107.2	34.75	89.3	28.53	71.5	22.49	53.6	16.61
-5.0	-5.6	172.5	172.5	61.15	155.3	54.27	138.0	47.56	120.8	41.02	103.5	34.65	86.3	28.45	69.0	22.42	51.8	16.56
-7.0	-7.6	166.1	166.1	60.95	149.5	54.09	132.9	47.40	116.2	40.88	99.6	34.53	83.0	28.35	66.4	22.34	49.8	16.50
-10	-10.5	156.7	156.7	60.67	141.0	53.84	125.4	47.18	109.7	40.69	94.0	34.37	78.3	28.22	62.7	22.24	47.0	16.42
-14.5	-15.0	142.2	142.2	60.22	127.9	53.44	113.7	46.83	99.5	40.39	85.3	34.12	71.1	28.01	56.9	22.07	42.6	16.30
-19.5	-20.0	126.0	126.0	59.72	113.4	53.00	100.8	46.44	88.2	40.05	75.6	33.83	63.0	27.78	50.4	21.89	37.8	16.17

TC : Total Capacity PI : Power Input
 Indoor air temperature conditions : 20.0°C dry-bulb

MMY-UP7411HT8P-E (74HP, 207.5 kW system)

Outdoor Unit Dry-Bulb (°C)		Outdoor Unit 100% Cooling Capacity (kW)	Compressor + Outdoor Fan Power consumption (kW)															
			100% Capacity		90% Capacity		80% Capacity		70% Capacity		60% Capacity		50% Capacity		40% Capacity		30% Capacity	
			TC (kW)	PI (kW)	TC (kW)	PI (kW)	TC (kW)	PI (kW)	TC (kW)	PI (kW)	TC (kW)	PI (kW)	TC (kW)	PI (kW)	TC (kW)	PI (kW)	TC (kW)	PI (kW)
46 °C		162.5	162.5	75.30	146.3	61.04	130.0	48.28	113.8	37.01	97.5	27.23	81.3	18.96	65.0	12.17	48.8	6.89
43 °C		178.3	178.3	76.69	160.4	62.16	142.6	49.16	124.8	37.69	107.0	27.73	89.1	19.30	71.3	12.39	53.5	7.01
41 °C		189.9	189.9	78.61	170.9	63.72	151.9	50.39	132.9	38.63	113.9	28.42	94.9	19.78	75.9	12.70	57.0	7.18
39 °C		196.2	196.2	76.32	176.6	61.87	157.0	48.93	137.3	37.50	117.7	27.60	98.1	19.21	78.5	12.33	58.9	6.97
37 °C		202.1	202.1	74.01	181.8	59.99	161.6	47.45	141.4	36.37	121.2	26.76	101.0	18.62	80.8	11.96	60.6	6.76
35 °C		207.5	207.5	73.27	186.8	58.12	166.0	45.96	145.3	35.23	124.5	25.92	103.8	18.04	83.0	11.58	62.3	6.55
32 °C		207.5	207.5	66.13	186.8	53.61	166.0	42.39	145.3	32.50	124.5	23.91	103.8	16.64	83.0	10.69	62.3	6.05
31 °C		207.5	207.5	61.20	186.8	49.61	166.0	39.23	145.3	30.07	124.5	22.13	103.8	15.40	83.0	9.89	62.3	5.60
30 °C		207.5	207.5	58.93	186.8	47.77	166.0	37.78	145.3	28.96	124.5	21.31	103.8	14.83	83.0	9.53	62.3	5.39
29 °C		207.5	207.5	56.78	186.8	46.03	166.0	36.41	145.3	27.91	124.5	20.54	103.8	14.30	83.0	9.18	62.3	5.19
27 °C		207.5	207.5	52.81	186.8	42.81	166.0	33.86	145.3	25.95	124.5	19.10	103.8	13.30	83.0	8.54	62.3	4.83
25 °C		207.5	207.5	49.19	186.8	39.87	166.0	31.54	145.3	24.18	124.5	17.79	103.8	12.39	83.0	7.96	62.3	4.50
23 °C		207.5	207.5	46.88	186.8	38.01	166.0	30.06	145.3	23.04	124.5	16.96	103.8	11.81	83.0	7.58	62.3	4.29
21 °C		207.5	207.5	45.79	186.8	37.12	166.0	29.36	145.3	22.51	124.5	16.56	103.8	11.53	83.0	7.41	62.3	4.19
20 °C		207.5	207.5	45.30	186.8	36.72	166.0	29.04	145.3	22.27	124.5	16.39	103.8	11.41	83.0	7.33	62.3	4.15
19 °C		207.5	207.5	44.84	186.8	36.35	166.0	28.75	145.3	22.04	124.5	16.22	103.8	11.29	83.0	7.26	62.3	4.11
17 °C		207.5	207.5	44.03	186.8	35.70	166.0	28.24	145.3	21.65	124.5	15.93	103.8	11.09	83.0	7.13	62.3	4.03
15 °C		207.5	207.5	43.34	186.8	35.14	166.0	27.79	145.3	21.31	124.5	15.68	103.8	10.92	83.0	7.01	62.3	3.97

TC : Total Capacity PI : Power Input
Indoor air temperature conditions : 27.0°C dry-bulb / 19.0°C wet bulb

Outdoor Unit Dry-Bulb / Wet-Bulb (°C) / (°C)		Outdoor Unit 100% Heating Capacity (kW)	Compressor + Outdoor Fan Power consumption (kW)															
			100% Capacity		90% Capacity		80% Capacity		70% Capacity		60% Capacity		50% Capacity		40% Capacity		30% Capacity	
			TC (kW)	PI (kW)	TC (kW)	PI (kW)	TC (kW)	PI (kW)	TC (kW)	PI (kW)	TC (kW)	PI (kW)	TC (kW)	PI (kW)	TC (kW)	PI (kW)	TC (kW)	PI (kW)
15.0	13.7	222.5	222.5	55.33	200.3	48.82	178.0	42.54	155.8	36.46	133.5	30.61	111.3	24.97	89.0	19.54	66.8	14.33
13.0	11.8	222.5	222.5	56.94	200.3	50.22	178.0	43.74	155.8	37.48	133.5	31.44	111.3	25.63	89.0	20.05	66.8	14.70
11.0	9.8	222.5	222.5	58.75	200.3	51.79	178.0	45.08	155.8	38.61	133.5	32.37	111.3	26.38	89.0	20.63	66.8	15.11
9.0	7.9	222.5	222.5	60.58	200.3	53.39	178.0	46.44	155.8	39.76	133.5	33.32	111.3	27.14	89.0	21.20	66.8	15.52
7.0	6.0	222.5	222.5	62.54	200.3	55.09	178.0	47.90	155.8	40.98	133.5	34.33	111.3	27.94	89.0	21.82	66.8	15.96
5.0	4.1	216.0	216.0	62.35	194.4	54.92	172.8	47.75	151.2	40.86	129.6	34.22	108.0	27.85	86.4	21.75	64.8	15.91
3.0	2.2	209.5	209.5	62.16	188.5	54.75	167.6	47.61	146.6	40.73	125.7	34.12	104.7	27.77	83.8	21.69	62.8	15.87
0.0	-0.7	199.6	199.6	61.87	179.6	54.50	159.7	47.39	139.7	40.54	119.7	33.96	99.8	27.64	79.8	21.58	59.9	15.79
-3.0	-3.7	189.3	189.3	61.57	170.4	54.23	151.4	47.16	132.5	40.34	113.6	33.79	94.6	27.50	75.7	21.48	56.8	15.72
-5.0	-5.6	182.8	182.8	61.38	164.5	54.06	146.2	47.01	128.0	40.22	109.7	33.69	91.4	27.42	73.1	21.41	54.8	15.67
-7.0	-7.6	175.9	175.9	61.18	158.4	53.89	140.8	46.86	123.2	40.09	105.6	33.58	88.0	27.33	70.4	21.34	52.8	15.62
-10	-10.5	166.0	166.0	60.89	149.4	53.63	132.8	46.64	116.2	39.90	99.6	33.42	83.0	27.20	66.4	21.24	49.8	15.54
-14.5	-15.0	150.6	150.6	60.44	135.6	53.24	120.5	46.29	105.4	39.60	90.4	33.17	75.3	27.00	60.2	21.08	45.2	15.43
-19.5	-20.0	133.5	133.5	59.94	120.2	52.80	106.8	45.91	93.5	39.28	80.1	32.90	66.8	26.78	53.4	20.91	40.1	15.30

TC : Total Capacity PI : Power Input
Indoor air temperature conditions : 20.0°C dry-bulb

MMY-UP7611HT8P-E (76HP, 214.0 kW system)

Outdoor Unit Dry-Bulb (°C)		Outdoor Unit 100% Cooling Capacity (kW)	Compressor + Outdoor Fan Power consumption (kW)															
			100% Capacity		90% Capacity		80% Capacity		70% Capacity		60% Capacity		50% Capacity		40% Capacity		30% Capacity	
			TC (kW)	PI (kW)	TC (kW)	PI (kW)	TC (kW)	PI (kW)	TC (kW)	PI (kW)	TC (kW)	PI (kW)	TC (kW)	PI (kW)	TC (kW)	PI (kW)	TC (kW)	PI (kW)
46 °C		167.6	167.6	79.65	150.9	64.51	134.1	50.97	117.3	39.03	100.6	28.67	83.8	19.91	67.0	12.74	50.3	7.17
43 °C		183.8	183.8	81.13	165.5	65.72	147.1	51.92	128.7	39.75	110.3	29.21	91.9	20.28	73.5	12.98	55.2	7.30
41 °C		195.8	195.8	83.18	176.2	67.37	156.7	53.23	137.1	40.76	117.5	29.94	97.9	20.79	78.3	13.31	58.7	7.49
39 °C		202.3	202.3	80.76	182.1	65.42	161.9	51.69	141.6	39.57	121.4	29.07	101.2	20.19	80.9	12.92	60.7	7.27
37 °C		208.4	208.4	78.31	187.5	63.43	166.7	50.12	145.9	38.37	125.0	28.19	104.2	19.58	83.4	12.53	62.5	7.05
35 °C		214.0	214.0	77.48	192.6	61.45	171.2	48.55	149.8	37.17	128.4	27.31	107.0	18.97	85.6	12.14	64.2	6.83
32 °C		214.0	214.0	69.96	192.6	56.67	171.2	44.78	149.8	34.28	128.4	25.19	107.0	17.49	85.6	11.19	64.2	6.30
31 °C		214.0	214.0	64.73	192.6	52.43	171.2	41.43	149.8	31.72	128.4	23.30	107.0	16.18	85.6	10.36	64.2	5.83
30 °C		214.0	214.0	62.33	192.6	50.49	171.2	39.89	149.8	30.54	128.4	22.44	107.0	15.58	85.6	9.97	64.2	5.61
29 °C		214.0	214.0	60.06	192.6	48.65	171.2	38.44	149.8	29.43	128.4	21.62	107.0	15.01	85.6	9.61	64.2	5.41
27 °C		214.0	214.0	55.84	192.6	45.23	171.2	35.74	149.8	27.36	128.4	20.10	107.0	13.96	85.6	8.94	64.2	5.03
25 °C		214.0	214.0	52.01	192.6	42.13	171.2	33.29	149.8	25.49	128.4	18.72	107.0	13.00	85.6	8.32	64.2	4.68
23 °C		214.0	214.0	49.57	192.6	40.15	171.2	31.72	149.8	24.29	128.4	17.85	107.0	12.39	85.6	7.93	64.2	4.46
21 °C		214.0	214.0	48.41	192.6	39.21	171.2	30.98	149.8	23.72	128.4	17.43	107.0	12.10	85.6	7.75	64.2	4.36
20 °C		214.0	214.0	47.89	192.6	38.79	171.2	30.65	149.8	23.46	128.4	17.24	107.0	11.97	85.6	7.66	64.2	4.31
19 °C		214.0	214.0	47.41	192.6	38.40	171.2	30.34	149.8	23.23	128.4	17.07	107.0	11.85	85.6	7.58	64.2	4.27
17 °C		214.0	214.0	46.55	192.6	37.70	171.2	29.79	149.8	22.81	128.4	16.76	107.0	11.64	85.6	7.45	64.2	4.19
15 °C		214.0	214.0	45.81	192.6	37.11	171.2	29.32	149.8	22.45	128.4	16.49	107.0	11.45	85.6	7.33	64.2	4.12

TC : Total Capacity PI : Power Input
Indoor air temperature conditions : 27.0°C dry-bulb / 19.0°C wet bulb

Outdoor Unit Dry-Bulb (°C)		Wet-Bulb (°C)	Outdoor Unit 100% Heating Capacity (kW)	Compressor + Outdoor Fan Power consumption (kW)															
				100% Capacity		90% Capacity		80% Capacity		70% Capacity		60% Capacity		50% Capacity		40% Capacity		30% Capacity	
				TC (kW)	PI (kW)	TC (kW)	PI (kW)	TC (kW)	PI (kW)	TC (kW)	PI (kW)	TC (kW)	PI (kW)	TC (kW)	PI (kW)	TC (kW)	PI (kW)	TC (kW)	PI (kW)
15.0	13.7	230.0	230.0	58.05	207.0	51.11	184.0	44.41	161.0	37.98	138.0	31.79	115.0	25.86	92.0	20.18	69.0	14.75	
13.0	11.8	230.0	230.0	59.78	207.0	52.60	184.0	45.69	161.0	39.05	138.0	32.67	115.0	26.56	92.0	20.71	69.0	15.14	
11.0	9.8	230.0	230.0	61.72	207.0	54.28	184.0	47.13	161.0	40.25	138.0	33.66	115.0	27.34	92.0	21.31	69.0	15.56	
9.0	7.9	230.0	230.0	63.69	207.0	55.99	184.0	48.58	161.0	41.47	138.0	34.66	115.0	28.14	92.0	21.92	69.0	15.99	
7.0	6.0	230.0	230.0	65.80	207.0	57.81	184.0	50.13	161.0	42.77	138.0	35.72	115.0	28.98	92.0	22.56	69.0	16.45	
5.0	4.1	223.3	223.3	65.60	201.0	57.64	178.6	49.98	156.3	42.64	134.0	35.61	111.6	28.90	89.3	22.49	67.0	16.40	
3.0	2.2	216.6	216.6	65.40	194.9	57.46	173.2	49.83	151.6	42.51	129.9	35.50	108.3	28.81	86.6	22.42	65.0	16.35	
0.0	-0.7	206.3	206.3	65.10	185.7	57.19	165.0	49.60	144.4	42.31	123.8	35.34	103.1	28.67	82.5	22.32	61.9	16.27	
-3.0	-3.7	195.7	195.7	64.78	176.1	56.91	156.5	49.36	137.0	42.11	117.4	35.17	97.8	28.53	78.3	22.21	58.7	16.20	
-5.0	-5.6	189.0	189.0	64.58	170.1	56.74	151.2	49.20	132.3	41.98	113.4	35.06	94.5	28.45	75.6	22.14	56.7	16.15	
-7.0	-7.6	181.9	181.9	64.37	163.7	56.55	145.5	49.04	127.3	41.84	109.1	34.94	90.9	28.35	72.8	22.07	54.6	16.09	
-10	-10.5	171.6	171.6	64.06	154.5	56.28	137.3	48.81	120.1	41.64	103.0	34.78	85.8	28.22	68.6	21.97	51.5	16.02	
-14.5	-15.0	155.7	155.7	63.59	140.1	55.87	124.6	48.45	109.0	41.33	93.4	34.52	77.8	28.01	62.3	21.80	46.7	15.90	
-19.5	-20.0	138.0	138.0	63.06	124.2	55.41	110.4	48.05	96.6	40.99	82.8	34.23	69.0	27.78	55.2	21.62	41.4	15.77	

TC : Total Capacity PI : Power Input
Indoor air temperature conditions : 20.0°C dry-bulb

MMY-UP7811HT8P-E (78HP, 219.0 kW system)

Cooling

Outdoor Unit Dry-Bulb (°C)		Outdoor Unit 100% Cooling Capacity (kW)	Compressor + Outdoor Fan Power consumption (kW)															
			100% Capacity		90% Capacity		80% Capacity		70% Capacity		60% Capacity		50% Capacity		40% Capacity		30% Capacity	
			TC (kW)	PI (kW)	TC (kW)	PI (kW)	TC (kW)	PI (kW)	TC (kW)	PI (kW)	TC (kW)	PI (kW)	TC (kW)	PI (kW)	TC (kW)	PI (kW)	TC (kW)	PI (kW)
46 °C	171.5	171.5	76.86	154.4	62.27	137.2	49.22	120.1	37.71	102.9	27.73	85.77	19.28	68.6	12.37	51.5	7.00	
43 °C	188.1	188.1	78.29	169.3	63.43	150.5	50.14	131.7	38.41	112.9	28.24	94.1	19.64	75.3	12.60	56.4	7.13	
41 °C	200.4	200.4	80.26	180.4	65.02	160.3	51.39	140.3	39.37	120.2	28.95	100.2	20.13	80.2	12.91	60.1	7.30	
39 °C	207.1	207.1	77.92	186.4	63.13	165.7	49.90	145.0	38.23	124.2	28.11	103.5	19.54	82.8	12.54	62.1	7.09	
37 °C	213.3	213.3	75.56	191.9	61.22	170.6	48.39	149.3	37.07	128.0	27.25	106.6	18.95	85.3	12.16	64.0	6.87	
35 °C	219.0	219.0	74.76	197.1	59.31	175.2	46.88	153.3	35.91	131.4	26.40	109.5	18.36	87.6	11.78	65.7	6.66	
32 °C	219.0	219.0	67.51	197.1	54.70	175.2	43.23	153.3	33.12	131.4	24.35	109.5	16.93	87.6	10.86	65.7	6.14	
31 °C	219.0	219.0	62.47	197.1	50.61	175.2	40.00	153.3	30.65	131.4	22.53	109.5	15.67	87.6	10.06	65.7	5.69	
30 °C	219.0	219.0	60.15	197.1	48.74	175.2	38.52	153.3	29.51	131.4	21.70	109.5	15.09	87.6	9.68	65.7	5.48	
29 °C	219.0	219.0	57.96	197.1	46.96	175.2	37.12	153.3	28.44	131.4	20.91	109.5	14.54	87.6	9.33	65.7	5.28	
27 °C	219.0	219.0	53.89	197.1	43.67	175.2	34.52	153.3	26.44	131.4	19.44	109.5	13.52	87.6	8.68	65.7	4.91	
25 °C	219.0	219.0	50.20	197.1	40.67	175.2	32.15	153.3	24.63	131.4	18.11	109.5	12.60	87.6	8.09	65.7	4.58	
23 °C	219.0	219.0	47.84	197.1	38.76	175.2	30.64	153.3	23.47	131.4	17.26	109.5	12.01	87.6	7.71	65.7	4.36	
21 °C	219.0	219.0	46.72	197.1	37.86	175.2	29.92	153.3	22.93	131.4	16.86	109.5	11.73	87.6	7.53	65.7	4.26	
20 °C	219.0	219.0	46.22	197.1	37.45	175.2	29.60	153.3	22.68	131.4	16.68	109.5	11.60	87.6	7.45	65.7	4.22	
19 °C	219.0	219.0	45.76	197.1	37.07	175.2	29.31	153.3	22.45	131.4	16.51	109.5	11.49	87.6	7.37	65.7	4.18	
17 °C	219.0	219.0	44.93	197.1	36.40	175.2	28.78	153.3	22.05	131.4	16.21	109.5	11.28	87.6	7.24	65.7	4.10	
15 °C	219.0	219.0	44.22	197.1	35.83	175.2	28.32	153.3	21.70	131.4	15.96	109.5	11.10	87.6	7.13	65.7	4.04	

TC : Total Capacity PI : Power Input
Indoor air temperature conditions : 27.0°C dry-bulb / 19.0°C wet bulb

Heating

Outdoor Unit Dry-Bulb (°C)		Wet-Bulb (°C)	Outdoor Unit 100% Heating Capacity (kW)	Compressor + Outdoor Fan Power consumption (kW)															
				100% Capacity		90% Capacity		80% Capacity		70% Capacity		60% Capacity		50% Capacity		40% Capacity		30% Capacity	
				TC (kW)	PI (kW)	TC (kW)	PI (kW)	TC (kW)	PI (kW)	TC (kW)	PI (kW)	TC (kW)	PI (kW)	TC (kW)	PI (kW)	TC (kW)	PI (kW)	TC (kW)	PI (kW)
15.0	13.7	241.0	241.0	59.81	216.9	52.31	192.8	45.17	168.7	38.37	144.6	31.93	120.5	25.84	96.4	20.10	72.3	14.71	
13.0	11.8	241.0	241.0	61.69	216.9	53.93	192.8	46.53	168.7	39.50	144.6	32.85	120.5	26.56	96.4	20.63	72.3	15.08	
11.0	9.8	241.0	241.0	63.82	216.9	55.75	192.8	48.07	168.7	40.77	144.6	33.87	120.5	27.36	96.4	21.24	72.3	15.50	
9.0	7.9	241.0	241.0	65.98	216.9	57.60	192.8	49.63	168.7	42.07	144.6	34.92	120.5	28.18	96.4	21.85	72.3	15.93	
7.0	6.0	241.0	241.0	68.30	216.9	59.58	192.8	51.30	168.7	43.45	144.6	36.03	120.5	29.05	96.4	22.50	72.3	16.38	
5.0	4.1	234.0	234.0	68.09	210.6	59.40	187.2	51.14	163.8	43.32	140.4	35.92	117.0	28.96	93.6	22.43	70.2	16.33	
3.0	2.2	226.9	226.9	67.89	204.2	59.22	181.5	50.99	158.8	43.18	136.1	35.81	113.5	28.87	90.8	22.36	68.1	16.28	
0.0	-0.7	216.2	216.2	67.57	194.5	58.94	172.9	50.75	151.3	42.98	129.7	35.64	108.1	28.74	86.5	22.26	64.8	16.21	
-3.0	-3.7	205.0	205.0	67.24	184.5	58.66	164.0	50.50	143.5	42.77	123.0	35.47	102.5	28.60	82.0	22.15	61.5	16.13	
-5.0	-5.6	198.0	198.0	67.03	178.2	58.48	158.4	50.35	138.6	42.64	118.8	35.36	99.0	28.51	79.2	22.08	59.4	16.08	
-7.0	-7.6	190.6	190.6	66.81	171.5	58.29	152.5	50.18	133.4	42.50	114.3	35.25	95.3	28.42	76.2	22.01	57.2	16.02	
-10	-10.5	179.8	179.8	66.50	161.8	58.01	143.9	49.94	125.9	42.30	107.9	35.08	89.9	28.28	71.9	21.90	53.9	15.95	
-14.5	-15.0	163.1	163.1	66.01	146.8	57.58	130.5	49.58	114.2	41.99	97.9	34.82	81.6	28.07	65.3	21.74	48.9	15.83	
-19.5	-20.0	144.6	144.6	65.46	130.1	57.10	115.7	49.16	101.2	41.64	86.8	34.53	72.3	27.84	57.8	21.56	43.4	15.70	

TC : Total Capacity PI : Power Input
Indoor air temperature conditions : 20.0°C dry-bulb

MMY-UP8011HT8P-E (80HP, 223.5 kW system)

Cooling		Compressor + Outdoor Fan Power consumption (kW)																	
		Outdoor Unit Dry-Bulb (°C)	Outdoor Unit 100% Cooling Capacity (kW)	100% Capacity		90% Capacity		80% Capacity		70% Capacity		60% Capacity		50% Capacity		40% Capacity		30% Capacity	
				TC (kW)	PI (kW)	TC (kW)	PI (kW)	TC (kW)	PI (kW)	TC (kW)	PI (kW)	TC (kW)	PI (kW)	TC (kW)	PI (kW)	TC (kW)	PI (kW)	TC (kW)	PI (kW)
46 °C	175.1	175.1	78.86	157.6	63.94	140.0	50.57	122.5	38.78	105.0	28.55	87.5	19.88	70.0	12.78	52.5	7.25		
43 °C	192.0	192.0	80.32	172.8	65.11	153.6	51.50	134.4	39.49	115.2	29.07	96.0	20.24	76.8	13.01	57.6	7.38		
41 °C	204.5	204.5	82.32	184.1	66.74	163.6	52.79	143.2	40.47	122.7	29.79	102.3	20.74	81.8	13.33	61.4	7.56		
39 °C	211.3	211.3	79.93	190.2	64.80	169.1	51.25	147.9	39.29	126.8	28.92	105.7	20.14	84.5	12.94	63.4	7.34		
37 °C	217.6	217.6	77.51	195.9	62.84	174.1	49.70	152.3	38.10	130.6	28.05	108.8	19.53	87.1	12.55	65.3	7.11		
35 °C	223.5	223.5	76.73	201.2	60.87	178.8	48.15	156.5	36.91	134.1	27.17	111.8	18.92	89.4	12.16	67.1	6.89		
32 °C	223.5	223.5	69.26	201.2	56.15	178.8	44.41	156.5	34.05	134.1	25.06	111.8	17.45	89.4	11.22	67.1	6.36		
31 °C	223.5	223.5	64.09	201.2	51.96	178.8	41.10	156.5	31.51	134.1	23.20	111.8	16.15	89.4	10.39	67.1	5.89		
30 °C	223.5	223.5	61.72	201.2	50.04	178.8	39.58	156.5	30.35	134.1	22.34	111.8	15.56	89.4	10.00	67.1	5.67		
29 °C	223.5	223.5	59.47	201.2	48.21	178.8	38.14	156.5	29.24	134.1	21.53	111.8	14.99	89.4	9.64	67.1	5.47		
27 °C	223.5	223.5	55.31	201.2	44.84	178.8	35.47	156.5	27.20	134.1	20.02	111.8	13.95	89.4	8.97	67.1	5.09		
25 °C	223.5	223.5	51.52	201.2	41.77	178.8	33.04	156.5	25.33	134.1	18.65	111.8	12.99	89.4	8.36	67.1	4.74		
23 °C	223.5	223.5	49.10	201.2	39.81	178.8	31.49	156.5	24.15	134.1	17.78	111.8	12.39	89.4	7.97	67.1	4.52		
21 °C	223.5	223.5	47.96	201.2	38.88	178.8	30.76	156.5	23.59	134.1	17.37	111.8	12.10	89.4	7.78	67.1	4.42		
20 °C	223.5	223.5	47.44	201.2	38.47	178.8	30.43	156.5	23.33	134.1	17.18	111.8	11.97	89.4	7.70	67.1	4.37		
19 °C	223.5	223.5	46.97	201.2	38.08	178.8	30.13	156.5	23.10	134.1	17.01	111.8	11.85	89.4	7.62	67.1	4.33		
17 °C	223.5	223.5	46.12	201.2	37.39	178.8	29.58	156.5	22.69	134.1	16.70	111.8	11.64	89.4	7.49	67.1	4.25		
15 °C	223.5	223.5	45.40	201.2	36.81	178.8	29.12	156.5	22.33	134.1	16.44	111.8	11.46	89.4	7.37	67.1	4.18		

TC : Total Capacity PI : Power Input
 Indoor air temperature conditions : 27.0°C dry-bulb / 19.0°C wet bulb

Heating		Compressor + Outdoor Fan Power consumption (kW)																		
		Outdoor Unit Dry-Bulb (°C)	Outdoor Unit Wet-Bulb (°C)	Outdoor Unit 100% Heating Capacity (kW)	100% Capacity		90% Capacity		80% Capacity		70% Capacity		60% Capacity		50% Capacity		40% Capacity		30% Capacity	
					TC (kW)	PI (kW)	TC (kW)	PI (kW)	TC (kW)	PI (kW)	TC (kW)	PI (kW)	TC (kW)	PI (kW)	TC (kW)	PI (kW)	TC (kW)	PI (kW)	TC (kW)	PI (kW)
15.0	13.7	240.5	240.5	60.21	216.5	53.11	192.4	46.25	168.4	39.64	144.3	33.28	120.3	27.17	96.2	21.30	72.2	15.69		
13.0	11.8	240.5	240.5	61.97	216.5	54.64	192.4	47.56	168.4	40.74	144.3	34.19	120.3	27.89	96.2	21.86	72.2	16.08		
11.0	9.8	240.5	240.5	63.95	216.5	56.35	192.4	49.03	168.4	41.97	144.3	35.20	120.3	28.70	96.2	22.47	72.2	16.52		
9.0	7.9	240.5	240.5	65.96	216.5	58.09	192.4	50.51	168.4	43.22	144.3	36.22	120.3	29.51	96.2	23.10	72.2	16.97		
7.0	6.0	240.5	240.5	68.11	216.5	59.95	192.4	52.10	168.4	44.56	144.3	37.32	120.3	30.39	96.2	23.76	72.2	17.44		
5.0	4.1	233.5	233.5	67.90	210.1	59.77	186.8	51.94	163.4	44.42	140.1	37.20	116.7	30.29	93.4	23.69	70.0	17.39		
3.0	2.2	226.4	226.4	67.70	203.8	59.59	181.2	51.79	158.5	44.29	135.9	37.09	113.2	30.20	90.6	23.61	67.9	17.33		
0.0	-0.7	215.7	215.7	67.38	194.1	59.31	172.6	51.54	151.0	44.08	129.4	36.92	107.9	30.06	86.3	23.50	64.7	17.25		
-3.0	-3.7	204.6	204.6	67.05	184.2	59.02	163.7	51.29	143.2	43.87	122.8	36.74	102.3	29.91	81.8	23.39	61.4	17.17		
-5.0	-5.6	197.6	197.6	66.85	177.8	58.84	158.1	51.13	138.3	43.73	118.5	36.63	98.8	29.82	79.0	23.32	59.3	17.12		
-7.0	-7.6	190.2	190.2	66.63	171.2	58.65	152.1	50.97	133.1	43.59	114.1	36.51	95.1	29.72	76.1	23.24	57.1	17.06		
-10	-10.5	179.5	179.5	66.31	161.5	58.37	143.6	50.73	125.6	43.38	107.7	36.33	89.7	29.58	71.8	23.13	53.8	16.98		
-14.5	-15.0	162.8	162.8	65.82	146.5	57.94	130.2	50.35	114.0	43.06	97.7	36.06	81.4	29.36	65.1	22.96	48.8	16.85		
-19.5	-20.0	144.3	144.3	65.28	129.9	57.46	115.4	49.93	101.0	42.70	86.6	35.77	72.2	29.12	57.7	22.77	43.3	16.71		

TC : Total Capacity PI : Power Input
 Indoor air temperature conditions : 20.0°C dry-bulb

MMY-UP8211HT8P-E (82HP, 230.0kW system)

Outdoor Unit Dry-Bulb (°C)		Outdoor Unit 100% Cooling Capacity (kW)	Compressor + Outdoor Fan Power consumption (kW)															
			100% Capacity		90% Capacity		80% Capacity		70% Capacity		60% Capacity		50% Capacity		40% Capacity		30% Capacity	
			TC (kW)	PI (kW)	TC (kW)	PI (kW)	TC (kW)	PI (kW)	TC (kW)	PI (kW)	TC (kW)	PI (kW)	TC (kW)	PI (kW)	TC (kW)	PI (kW)	TC (kW)	PI (kW)
46 °C		180.1	83.21	162.1	67.41	144.1	53.27	126.1	40.80	108.1	29.98	90.1	20.84	72.1	13.35	54.0	7.53	
43 °C		197.6	84.76	177.8	68.66	158.1	54.26	138.3	41.55	118.6	30.54	98.8	21.22	79.0	13.60	59.3	7.67	
41 °C		210.5	86.89	189.4	70.39	168.4	55.63	147.3	42.60	126.3	31.31	105.2	21.76	84.2	13.94	63.1	7.86	
39 °C		217.5	84.37	195.7	68.35	174.0	54.01	152.2	41.36	130.5	30.40	108.7	21.12	87.0	13.53	65.2	7.63	
37 °C		224.0	81.81	201.6	66.28	179.2	52.37	156.8	40.11	134.4	29.48	112.0	20.48	89.6	13.12	67.2	7.40	
35 °C		230.0	80.94	207.0	64.20	184.0	50.74	161.0	38.85	138.0	28.56	115.0	19.84	92.0	12.71	69.0	7.17	
32 °C		230.0	73.09	207.0	59.21	184.0	46.79	161.0	35.83	138.0	26.34	115.0	18.30	92.0	11.73	69.0	6.61	
31 °C		230.0	67.63	207.0	54.79	184.0	43.30	161.0	33.16	138.0	24.37	115.0	16.93	92.0	10.85	69.0	6.12	
30 °C		230.0	65.12	207.0	52.76	184.0	41.69	161.0	31.93	138.0	23.47	115.0	16.31	92.0	10.45	69.0	5.89	
29 °C		230.0	62.75	207.0	50.83	184.0	40.17	161.0	30.76	138.0	22.61	115.0	15.71	92.0	10.07	69.0	5.68	
27 °C		230.0	58.34	207.0	47.27	184.0	37.35	161.0	28.61	138.0	21.03	115.0	14.61	92.0	9.36	69.0	5.28	
25 °C		230.0	54.34	207.0	44.02	184.0	34.79	161.0	26.64	138.0	19.58	115.0	13.61	92.0	8.72	69.0	4.92	
23 °C		230.0	51.79	207.0	41.96	184.0	33.16	161.0	25.39	138.0	18.66	115.0	12.97	92.0	8.31	69.0	4.69	
21 °C		230.0	50.58	207.0	40.97	184.0	32.38	161.0	24.80	138.0	18.23	115.0	12.67	92.0	8.12	69.0	4.58	
20 °C		230.0	50.03	207.0	40.53	184.0	32.03	161.0	24.53	138.0	18.03	115.0	12.53	92.0	8.03	69.0	4.53	
19 °C		230.0	49.53	207.0	40.13	184.0	31.71	161.0	24.29	138.0	17.85	115.0	12.41	92.0	7.95	69.0	4.49	
17 °C		230.0	48.64	207.0	39.40	184.0	31.14	161.0	23.85	138.0	17.53	115.0	12.18	92.0	7.81	69.0	4.41	
15 °C		230.0	47.87	207.0	38.78	184.0	30.65	161.0	23.47	138.0	17.25	115.0	11.99	92.0	7.69	69.0	4.34	

TC : Total Capacity PI : Power Input
Indoor air temperature conditions : 27.0°C dry-bulb / 19.0°C wet bulb

Outdoor Unit Dry-Bulb (°C)		Outdoor Unit Wet-Bulb (°C)	Outdoor Unit 100% Heating Capacity (kW)	Compressor + Outdoor Fan Power consumption (kW)															
				100% Capacity		90% Capacity		80% Capacity		70% Capacity		60% Capacity		50% Capacity		40% Capacity		30% Capacity	
				TC (kW)	PI (kW)	TC (kW)	PI (kW)	TC (kW)	PI (kW)	TC (kW)	PI (kW)	TC (kW)	PI (kW)	TC (kW)	PI (kW)	TC (kW)	PI (kW)	TC (kW)	PI (kW)
15.0	13.7	248.0	62.94	223.2	55.39	198.4	48.13	173.6	41.15	148.8	34.46	124.0	28.06	99.2	21.94	74.4	16.11		
13.0	11.8	248.0	64.82	223.2	57.02	198.4	49.52	173.6	42.31	148.8	35.41	124.0	28.81	99.2	22.51	74.4	16.52		
11.0	9.8	248.0	66.93	223.2	58.84	198.4	51.07	173.6	43.62	148.8	36.48	124.0	29.66	99.2	23.16	74.4	16.97		
9.0	7.9	248.0	69.07	223.2	60.69	198.4	52.65	173.6	44.94	148.8	37.56	124.0	30.52	99.2	23.81	74.4	17.43		
7.0	6.0	248.0	71.37	223.2	62.68	198.4	54.34	173.6	46.35	148.8	38.71	124.0	31.43	99.2	24.50	74.4	17.93		
5.0	4.1	240.8	71.15	216.7	62.49	192.6	54.17	168.5	46.21	144.5	38.60	120.4	31.34	96.3	24.43	72.2	17.87		
3.0	2.2	233.5	70.94	210.2	62.30	186.8	54.01	163.5	46.07	140.1	38.48	116.8	31.24	93.4	24.35	70.1	17.82		
0.0	-0.7	222.4	70.61	200.2	62.00	178.0	53.75	155.7	45.85	133.5	38.30	111.2	31.09	89.0	24.24	66.7	17.73		
-3.0	-3.7	211.0	70.26	189.9	61.70	168.8	53.49	147.7	45.63	126.6	38.11	105.5	30.94	84.4	24.12	63.3	17.65		
-5.0	-5.6	203.7	70.05	183.4	61.51	163.0	53.33	142.6	45.49	122.2	37.99	101.9	30.85	81.5	24.05	61.1	17.59		
-7.0	-7.6	196.1	69.82	176.5	61.31	156.9	53.15	137.3	45.34	117.7	37.87	98.1	30.75	78.4	23.97	58.8	17.54		
-10	-10.5	185.0	69.49	166.5	61.02	148.0	52.90	129.5	45.12	111.0	37.69	92.5	30.60	74.0	23.86	55.5	17.45		
-14.5	-15.0	167.9	68.97	151.1	60.57	134.3	52.51	117.5	44.79	100.7	37.41	83.9	30.37	67.2	23.68	50.4	17.32		
-19.5	-20.0	148.8	68.40	133.9	60.07	119.0	52.08	104.2	44.42	89.3	37.10	74.4	30.12	59.5	23.48	44.6	17.18		

TC : Total Capacity PI : Power Input
Indoor air temperature conditions : 20.0°C dry-bulb

MMY-UP8411HT8P-E (84HP, 234.5 kW system)

Outdoor Unit Dry-Bulb (°C)	Outdoor Unit 100% Cooling Capacity (kW)	Compressor + Outdoor Fan Power consumption (kW)															
		100% Capacity		90% Capacity		80% Capacity		70% Capacity		60% Capacity		50% Capacity		40% Capacity		30% Capacity	
		TC (kW)	PI (kW)	TC (kW)	PI (kW)	TC (kW)	PI (kW)	TC (kW)	PI (kW)	TC (kW)	PI (kW)	TC (kW)	PI (kW)	TC (kW)	PI (kW)	TC (kW)	PI (kW)
46 °C	183.7	183.7	85.21	165.3	69.07	146.9	54.62	128.6	41.86	110.2	30.80	91.84	21.43	73.5	13.76	55.1	7.78
43 °C	201.5	201.5	86.79	181.3	70.34	161.2	55.63	141.0	42.63	120.9	31.37	100.7	21.83	80.6	14.01	60.4	7.92
41 °C	214.6	214.6	88.96	193.1	72.11	171.7	57.02	150.2	43.70	128.7	32.15	107.3	22.37	85.8	14.36	64.4	8.11
39 °C	221.7	221.7	86.38	199.6	70.01	177.4	55.36	155.2	42.43	133.0	31.22	110.9	21.72	88.7	13.94	66.5	7.88
37 °C	228.3	228.3	83.76	205.5	67.89	182.7	53.68	159.8	41.14	137.0	30.27	114.2	21.06	91.3	13.52	68.5	7.64
35 °C	234.5	234.5	82.91	211.1	65.77	187.6	52.01	164.2	39.86	140.7	29.32	117.3	20.40	93.8	13.10	70.4	7.40
32 °C	234.5	234.5	74.84	211.1	60.66	187.6	47.97	164.2	36.76	140.7	27.05	117.3	18.82	93.8	12.08	70.4	6.83
31 °C	234.5	234.5	69.25	211.1	56.13	187.6	44.39	164.2	34.02	140.7	25.03	117.3	17.42	93.8	11.18	70.4	6.32
30 °C	234.5	234.5	66.69	211.1	54.06	187.6	42.75	164.2	32.76	140.7	24.11	117.3	16.77	93.8	10.77	70.4	6.09
29 °C	234.5	234.5	64.26	211.1	52.09	187.6	41.19	164.2	31.57	140.7	23.23	117.3	16.16	93.8	10.38	70.4	5.87
27 °C	234.5	234.5	59.76	211.1	48.44	187.6	38.30	164.2	29.36	140.7	21.60	117.3	15.03	93.8	9.65	70.4	5.46
25 °C	234.5	234.5	55.66	211.1	45.12	187.6	35.68	164.2	27.35	140.7	20.12	117.3	14.00	93.8	8.99	70.4	5.08
23 °C	234.5	234.5	53.05	211.1	43.00	187.6	34.01	164.2	26.07	140.7	19.18	117.3	13.35	93.8	8.57	70.4	4.85
21 °C	234.5	234.5	51.81	211.1	42.00	187.6	33.21	164.2	25.46	140.7	18.73	117.3	13.04	93.8	8.37	70.4	4.73
20 °C	234.5	234.5	51.26	211.1	41.55	187.6	32.86	164.2	25.19	140.7	18.53	117.3	12.90	93.8	8.28	70.4	4.68
19 °C	234.5	234.5	50.74	211.1	41.13	187.6	32.53	164.2	24.94	140.7	18.35	117.3	12.77	93.8	8.20	70.4	4.64
17 °C	234.5	234.5	49.83	211.1	40.39	187.6	31.94	164.2	24.49	140.7	18.02	117.3	12.54	93.8	8.05	70.4	4.55
15 °C	234.5	234.5	49.05	211.1	39.76	187.6	31.44	164.2	24.10	140.7	17.74	117.3	12.34	93.8	7.93	70.4	4.48

TC : Total Capacity PI : Power Input
Indoor air temperature conditions : 27.0°C dry-bulb / 19.0°C wet bulb

Outdoor Unit		Outdoor Unit 100% Heating Capacity (kW)	Compressor + Outdoor Fan Power consumption (kW)															
Dry-Bulb (°C)	Wet-Bulb (°C)		100% Capacity		90% Capacity		80% Capacity		70% Capacity		60% Capacity		50% Capacity		40% Capacity		30% Capacity	
(°C)	(°C)		TC (kW)	PI (kW)	TC (kW)	PI (kW)	TC (kW)	PI (kW)	TC (kW)	PI (kW)	TC (kW)	PI (kW)	TC (kW)	PI (kW)	TC (kW)	PI (kW)	TC (kW)	PI (kW)
15.0	13.7	247.5	247.5	63.34	222.8	56.19	198.0	49.21	173.3	42.42	148.5	35.81	123.8	29.39	99.0	23.15	74.3	17.09
13.0	11.8	247.5	247.5	65.10	222.8	57.72	198.0	50.54	173.3	43.55	148.5	36.76	123.8	30.15	99.0	23.74	74.3	17.51
11.0	9.8	247.5	247.5	67.06	222.8	59.45	198.0	52.03	173.3	44.82	148.5	37.81	123.8	31.00	99.0	24.39	74.3	17.99
9.0	7.9	247.5	247.5	69.06	222.8	61.19	198.0	53.54	173.3	46.10	148.5	38.87	123.8	31.86	99.0	25.06	74.3	18.47
7.0	6.0	247.5	247.5	71.18	222.8	63.05	198.0	55.14	173.3	47.46	148.5	40.00	123.8	32.77	99.0	25.76	74.3	18.98
5.0	4.1	240.3	240.3	70.96	216.2	62.86	192.2	54.97	168.2	47.31	144.2	39.88	120.1	32.67	96.1	25.69	72.1	18.93
3.0	2.2	233.0	233.0	70.75	209.7	62.66	186.4	54.80	163.1	47.17	139.8	39.76	116.5	32.57	93.2	25.61	69.9	18.87
0.0	-0.7	222.0	222.0	70.42	199.8	62.37	177.6	54.55	155.4	46.95	133.2	39.57	111.0	32.42	88.8	25.49	66.6	18.78
-3.0	-3.7	210.6	210.6	70.08	189.5	62.07	168.5	54.28	147.4	46.72	126.3	39.38	105.3	32.26	84.2	25.36	63.2	18.69
-5.0	-5.6	203.3	203.3	69.86	183.0	61.88	162.7	54.12	142.3	46.58	122.0	39.26	101.7	32.16	81.3	25.29	61.0	18.63
-7.0	-7.6	195.7	195.7	69.63	176.1	61.68	156.6	53.94	137.0	46.42	117.4	39.13	97.9	32.06	78.3	25.20	58.7	18.57
-10	-10.5	184.7	184.7	69.30	166.2	61.38	147.7	53.68	129.3	46.20	110.8	38.94	92.3	31.90	73.9	25.08	55.4	18.48
-14.5	-15.0	167.5	167.5	68.79	150.8	60.93	134.0	53.29	117.3	45.86	100.5	38.66	83.8	31.67	67.0	24.90	50.3	18.35
-19.5	-20.0	148.5	148.5	68.22	133.7	60.42	118.8	52.85	104.0	45.48	89.1	38.34	74.3	31.41	59.4	24.69	44.6	18.19

TC : Total Capacity PI : Power Input
Indoor air temperature conditions : 20.0°C dry-bulb

MMY-UP8611HT8P-E (86HP, 241.0 kW system)

Cooling		Compressor + Outdoor Fan Power consumption (kW)																	
		Outdoor Unit		100% Capacity		90% Capacity		80% Capacity		70% Capacity		60% Capacity		50% Capacity		40% Capacity		30% Capacity	
		Dry-Bulb (°C)	100% Cooling Capacity (kW)	TC (kW)	PI (kW)	TC (kW)	PI (kW)	TC (kW)	PI (kW)	TC (kW)	PI (kW)	TC (kW)	PI (kW)	TC (kW)	PI (kW)	TC (kW)	PI (kW)	TC (kW)	PI (kW)
46 °C	188.8	188.8	89.56	169.9	72.54	151.0	57.32	132.1	43.88	113.3	32.24	94.4	22.39	75.5	14.33	56.6	8.06		
43 °C	207.0	207.0	91.23	186.3	73.90	165.6	58.39	144.9	44.70	124.2	32.84	103.5	22.81	82.8	14.60	62.1	8.21		
41 °C	220.5	220.5	93.53	198.5	75.76	176.4	59.86	154.4	45.83	132.3	33.67	110.3	23.38	88.2	14.96	66.2	8.42		
39 °C	227.9	227.9	90.81	205.1	73.56	182.3	58.12	159.5	44.50	136.7	32.69	113.9	22.70	91.1	14.53	68.4	8.17		
37 °C	234.7	234.7	88.06	211.2	71.33	187.7	56.36	164.3	43.15	140.8	31.70	117.3	22.02	93.9	14.09	70.4	7.93		
35 °C	241.0	241.0	87.12	216.9	69.10	192.8	54.60	168.7	41.80	144.6	30.71	120.5	21.33	96.4	13.65	72.3	7.68		
32 °C	241.0	241.0	78.67	216.9	63.72	192.8	50.35	168.7	38.55	144.6	28.32	120.5	19.67	96.4	12.59	72.3	7.08		
31 °C	241.0	241.0	72.79	216.9	58.96	192.8	46.59	168.7	35.67	144.6	26.20	120.5	18.20	96.4	11.65	72.3	6.55		
30 °C	241.0	241.0	70.09	216.9	56.77	192.8	44.86	168.7	34.34	144.6	25.23	120.5	17.52	96.4	11.21	72.3	6.31		
29 °C	241.0	241.0	67.53	216.9	54.70	192.8	43.22	168.7	33.09	144.6	24.31	120.5	16.88	96.4	10.81	72.3	6.08		
27 °C	241.0	241.0	62.80	216.9	50.86	192.8	40.19	168.7	30.77	144.6	22.61	120.5	15.70	96.4	10.05	72.3	5.65		
25 °C	241.0	241.0	58.49	216.9	47.37	192.8	37.43	168.7	28.66	144.6	21.06	120.5	14.62	96.4	9.36	72.3	5.26		
23 °C	241.0	241.0	55.74	216.9	45.15	192.8	35.67	168.7	27.31	144.6	20.07	120.5	13.94	96.4	8.92	72.3	5.02		
21 °C	241.0	241.0	54.43	216.9	44.09	192.8	34.84	168.7	26.67	144.6	19.60	120.5	13.61	96.4	8.71	72.3	4.90		
20 °C	241.0	241.0	53.85	216.9	43.62	192.8	34.46	168.7	26.39	144.6	19.39	120.5	13.46	96.4	8.62	72.3	4.85		
19 °C	241.0	241.0	53.31	216.9	43.18	192.8	34.12	168.7	26.12	144.6	19.19	120.5	13.33	96.4	8.53	72.3	4.80		
17 °C	241.0	241.0	52.34	216.9	42.40	192.8	33.50	168.7	25.65	144.6	18.84	120.5	13.09	96.4	8.37	72.3	4.71		
15 °C	241.0	241.0	51.52	216.9	41.73	192.8	32.97	168.7	25.24	144.6	18.55	120.5	12.88	96.4	8.24	72.3	4.64		

TC : Total Capacity PI : Power Input
Indoor air temperature conditions : 27.0°C dry-bulb / 19.0°C wet bulb

Heating		Compressor + Outdoor Fan Power consumption (kW)																	
		Outdoor Unit		100% Capacity		90% Capacity		80% Capacity		70% Capacity		60% Capacity		50% Capacity		40% Capacity		30% Capacity	
		Dry-Bulb (°C)	Wet-Bulb (°C)	Heating Capacity (kW)	TC (kW)	PI (kW)	TC (kW)	PI (kW)	TC (kW)	PI (kW)	TC (kW)	PI (kW)	TC (kW)	PI (kW)	TC (kW)	PI (kW)	TC (kW)	PI (kW)	
15.0	13.7	255.0	255.0	66.07	229.5	58.47	204.0	51.09	178.5	43.93	153.0	37.00	127.5	30.28	102.0	23.78	76.5	17.51	
13.0	11.8	255.0	255.0	67.94	229.5	60.10	204.0	52.50	178.5	45.13	153.0	37.98	127.5	31.07	102.0	24.40	76.5	17.95	
11.0	9.8	255.0	255.0	70.04	229.5	61.94	204.0	54.08	178.5	46.46	153.0	39.09	127.5	31.96	102.0	25.08	76.5	18.44	
9.0	7.9	255.0	255.0	72.17	229.5	63.79	204.0	55.67	178.5	47.81	153.0	40.21	127.5	32.86	102.0	25.77	76.5	18.94	
7.0	6.0	255.0	255.0	74.44	229.5	65.77	204.0	57.37	178.5	49.25	153.0	41.39	127.5	33.81	102.0	26.51	76.5	19.47	
5.0	4.1	247.5	247.5	74.21	222.8	65.57	198.0	57.20	173.3	49.10	148.5	41.27	123.8	33.71	99.0	26.43	74.3	19.41	
3.0	2.2	240.1	240.1	73.99	216.1	65.37	192.1	57.02	168.1	48.95	144.1	41.14	120.0	33.61	96.0	26.35	72.0	19.35	
0.0	-0.7	228.7	228.7	73.64	205.8	65.07	183.0	56.76	160.1	48.72	137.2	40.95	114.4	33.45	91.5	26.22	68.6	19.26	
-3.0	-3.7	216.9	216.9	73.29	195.3	64.75	173.6	56.48	151.9	48.48	130.2	40.75	108.5	33.29	86.8	26.10	65.1	19.17	
-5.0	-5.6	209.5	209.5	73.06	188.5	64.55	167.6	56.31	146.6	48.33	125.7	40.63	104.7	33.19	83.8	26.01	62.8	19.11	
-7.0	-7.6	201.6	201.6	72.82	181.5	64.34	161.3	56.12	141.2	48.18	121.0	40.49	100.8	33.08	80.7	25.93	60.5	19.05	
-10	-10.5	190.3	190.3	72.48	171.2	64.03	152.2	55.86	133.2	47.95	114.2	40.30	95.1	32.92	76.1	25.81	57.1	18.96	
-14.5	-15.0	172.6	172.6	71.94	155.4	63.56	138.1	55.45	120.8	47.59	103.6	40.00	86.3	32.68	69.0	25.62	51.8	18.82	
-19.5	-20.0	153.0	153.0	71.34	137.7	63.03	122.4	54.99	107.1	47.20	91.8	39.67	76.5	32.41	61.2	25.40	45.9	18.66	

TC : Total Capacity PI : Power Input
Indoor air temperature conditions : 20.0°C dry-bulb

MMY-UP8811HT8P-E (88HP, 246.0 kW system)

Outdoor Unit Dry-Bulb (°C)		Outdoor Unit 100% Cooling Capacity (kW)	Compressor + Outdoor Fan Power consumption (kW)															
			100% Capacity		90% Capacity		80% Capacity		70% Capacity		60% Capacity		50% Capacity		40% Capacity		30% Capacity	
			TC (kW)	PI (kW)	TC (kW)	PI (kW)	TC (kW)	PI (kW)	TC (kW)	PI (kW)	TC (kW)	PI (kW)	TC (kW)	PI (kW)	TC (kW)	PI (kW)	TC (kW)	PI (kW)
46 °C		192.7	192.7	86.77	173.4	70.30	154.1	55.57	134.9	42.57	115.6	31.30	96.3	21.76	77.1	13.96	57.8	7.89
43 °C		211.3	211.3	88.39	190.2	71.61	169.1	56.60	147.9	43.35	126.8	31.88	105.7	22.16	84.5	14.22	63.4	8.03
41 °C		225.1	225.1	90.61	202.6	73.41	180.1	58.02	157.6	44.44	135.1	32.67	112.6	22.72	90.0	14.57	67.5	8.23
39 °C		232.6	232.6	87.98	209.3	71.28	186.1	56.33	162.8	43.15	139.6	31.72	116.3	22.06	93.0	14.15	69.8	7.99
37 °C		239.5	239.5	85.31	215.6	69.12	191.6	54.63	167.7	41.84	143.7	30.76	119.8	21.39	95.8	13.72	71.9	7.75
35 °C		246.0	246.0	84.40	221.4	66.96	196.8	52.92	172.2	40.54	147.6	29.80	123.0	20.72	98.4	13.29	73.8	7.51
32 °C		246.0	246.0	76.22	221.4	61.75	196.8	48.81	172.2	37.38	147.6	27.49	123.0	19.11	98.4	12.26	73.8	6.93
31 °C		246.0	246.0	70.52	221.4	57.14	196.8	45.16	172.2	34.59	147.6	25.43	123.0	17.69	98.4	11.34	73.8	6.41
30 °C		246.0	246.0	67.91	221.4	55.02	196.8	43.49	172.2	33.31	147.6	24.49	123.0	17.03	98.4	10.93	73.8	6.18
29 °C		246.0	246.0	65.43	221.4	53.01	196.8	41.90	172.2	32.10	147.6	23.60	123.0	16.41	98.4	10.53	73.8	5.95
27 °C		246.0	246.0	60.84	221.4	49.30	196.8	38.96	172.2	29.85	147.6	21.95	123.0	15.26	98.4	9.79	73.8	5.54
25 °C		246.0	246.0	56.67	221.4	45.92	196.8	36.29	172.2	27.80	147.6	20.44	123.0	14.22	98.4	9.12	73.8	5.16
23 °C		246.0	246.0	54.01	221.4	43.76	196.8	34.59	172.2	26.50	147.6	19.48	123.0	13.55	98.4	8.69	73.8	4.92
21 °C		246.0	246.0	52.75	221.4	42.74	196.8	33.78	172.2	25.88	147.6	19.03	123.0	13.23	98.4	8.49	73.8	4.80
20 °C		246.0	246.0	52.18	221.4	42.28	196.8	33.42	172.2	25.60	147.6	18.83	123.0	13.09	98.4	8.40	73.8	4.75
19 °C		246.0	246.0	51.66	221.4	41.85	196.8	33.08	172.2	25.34	147.6	18.64	123.0	12.96	98.4	8.32	73.8	4.71
17 °C		246.0	246.0	50.72	221.4	41.10	196.8	32.49	172.2	24.89	147.6	18.30	123.0	12.73	98.4	8.17	73.8	4.62
15 °C		246.0	246.0	49.92	221.4	40.45	196.8	31.97	172.2	24.50	147.6	18.01	123.0	12.53	98.4	8.04	73.8	4.55

TC : Total Capacity PI : Power Input
Indoor air temperature conditions : 27.0°C dry-bulb / 19.0°C wet bulb

Outdoor Unit Dry-Bulb (°C)		Outdoor Unit 100% Heating Capacity (kW)	Wet-Bulb (°C)	Compressor + Outdoor Fan Power consumption (kW)															
				100% Capacity		90% Capacity		80% Capacity		70% Capacity		60% Capacity		50% Capacity		40% Capacity		30% Capacity	
				TC (kW)	PI (kW)	TC (kW)	PI (kW)	TC (kW)	PI (kW)	TC (kW)	PI (kW)	TC (kW)	PI (kW)	TC (kW)	PI (kW)	TC (kW)	PI (kW)	TC (kW)	PI (kW)
15.0	13.7	266.0		266.0	67.82	239.4	59.68	212.8	51.84	186.2	44.33	159.6	37.14	133.0	30.26	106.4	23.70	79.8	17.46
13.0	11.8	266.0		266.0	69.85	239.4	61.43	212.8	53.34	186.2	45.58	159.6	38.16	133.0	31.07	106.4	24.32	79.8	17.90
11.0	9.8	266.0		266.0	72.14	239.4	63.40	212.8	55.02	186.2	46.98	159.6	39.30	133.0	31.98	106.4	25.00	79.8	18.38
9.0	7.9	266.0		266.0	74.46	239.4	65.40	212.8	56.72	186.2	48.41	159.6	40.47	133.0	32.90	106.4	25.70	79.8	18.88
7.0	6.0	266.0		266.0	76.94	239.4	67.54	212.8	58.54	186.2	49.92	159.6	41.70	133.0	33.88	106.4	26.44	79.8	19.40
5.0	4.1	258.2		258.2	76.71	232.4	67.34	206.6	58.36	180.8	49.77	154.9	41.58	129.1	33.77	103.3	26.36	77.5	19.34
3.0	2.2	250.5		250.5	76.47	225.4	67.13	200.4	58.18	175.3	49.62	150.3	41.45	125.2	33.67	100.2	26.28	75.1	19.28
0.0	-0.7	238.6		238.6	76.12	214.7	66.82	190.9	57.91	167.0	49.39	143.2	41.26	119.3	33.51	95.4	26.16	71.6	19.19
-3.0	-3.7	226.3		226.3	75.75	203.7	66.49	181.0	57.63	158.4	49.15	135.8	41.06	113.2	33.35	90.5	26.03	67.9	19.10
-5.0	-5.6	218.5		218.5	75.51	196.7	66.29	174.8	57.45	153.0	49.00	131.1	40.93	109.3	33.25	87.4	25.95	65.6	19.04
-7.0	-7.6	210.3		210.3	75.27	189.3	66.07	168.3	57.26	147.2	48.84	126.2	40.80	105.2	33.14	84.1	25.87	63.1	18.98
-10	-10.5	198.5		198.5	74.91	178.6	65.76	158.8	56.99	138.9	48.61	119.1	40.60	99.2	32.98	79.4	25.75	59.5	18.89
-14.5	-15.0	180.1		180.1	74.36	162.1	65.27	144.0	56.57	126.0	48.25	108.0	40.30	90.0	32.74	72.0	25.55	54.0	18.75
-19.5	-20.0	159.6		159.6	73.74	143.6	64.73	127.7	56.10	111.7	47.85	95.8	39.97	79.8	32.47	63.8	25.34	47.9	18.59

TC : Total Capacity PI : Power Input
Indoor air temperature conditions : 20.0°C dry-bulb

MMY-UP9011HT8P-E (90HP, 251.5 kW system)

Cooling

Outdoor Unit Dry-Bulb (°C)		Outdoor Unit 100% Cooling Capacity (kW)	Compressor + Outdoor Fan Power consumption (kW)															
			100% Capacity		90% Capacity		80% Capacity		70% Capacity		60% Capacity		50% Capacity		40% Capacity		30% Capacity	
			TC	PI	TC	PI	TC	PI	TC	PI	TC	PI	TC	PI	TC	PI	TC	PI
			(kW)	(kW)	(kW)	(kW)	(kW)	(kW)	(kW)	(kW)	(kW)	(kW)	(kW)	(kW)	(kW)	(kW)	(kW)	(kW)
46 °C		197.0	197.0	89.27	177.3	72.34	157.6	57.19	137.9	43.83	118.2	32.24	98.5	22.44	78.8	14.42	59.1	8.19
43 °C		216.1	216.1	90.92	194.4	73.68	172.8	58.25	151.2	44.63	129.6	32.83	108.0	22.85	86.4	14.68	64.8	8.33
41 °C		230.1	230.1	93.21	207.1	75.53	184.1	59.71	161.1	45.75	138.1	33.65	115.1	23.42	92.1	15.04	69.0	8.53
39 °C		237.8	237.8	90.50	214.0	73.33	190.2	57.97	166.5	44.42	142.7	32.68	118.9	22.74	95.1	14.61	71.3	8.28
37 °C		244.9	244.9	87.76	220.4	71.11	195.9	56.22	171.4	43.08	146.9	31.69	122.5	22.05	98.0	14.16	73.5	8.03
35 °C		251.5	251.5	86.82	226.4	68.89	201.2	54.46	176.1	41.73	150.9	30.70	125.8	21.36	100.6	13.72	75.5	7.78
32 °C		251.5	251.5	78.40	226.4	63.53	201.2	50.23	176.1	38.49	150.9	28.31	125.8	19.70	100.6	12.66	75.5	7.18
31 °C		251.5	251.5	72.55	226.4	58.79	201.2	46.48	176.1	35.62	150.9	26.20	125.8	18.24	100.6	11.72	75.5	6.65
30 °C		251.5	251.5	69.86	226.4	56.61	201.2	44.76	176.1	34.30	150.9	25.23	125.8	17.56	100.6	11.29	75.5	6.41
29 °C		251.5	251.5	67.32	226.4	54.55	201.2	43.13	176.1	33.05	150.9	24.32	125.8	16.92	100.6	10.88	75.5	6.17
27 °C		251.5	251.5	62.60	226.4	50.73	201.2	40.11	176.1	30.73	150.9	22.61	125.8	15.74	100.6	10.12	75.5	5.75
25 °C		251.5	251.5	58.30	226.4	47.25	201.2	37.36	176.1	28.63	150.9	21.07	125.8	14.66	100.6	9.43	75.5	5.35
23 °C		251.5	251.5	55.57	226.4	45.03	201.2	35.61	176.1	27.29	150.9	20.08	125.8	13.98	100.6	8.99	75.5	5.11
21 °C		251.5	251.5	54.27	226.4	43.98	201.2	34.77	176.1	26.65	150.9	19.61	125.8	13.65	100.6	8.78	75.5	4.99
20 °C		251.5	251.5	53.69	226.4	43.51	201.2	34.40	176.1	26.37	150.9	19.40	125.8	13.51	100.6	8.69	75.5	4.94
19 °C		251.5	251.5	53.15	226.4	43.07	201.2	34.06	176.1	26.10	150.9	19.21	125.8	13.37	100.6	8.60	75.5	4.89
17 °C		251.5	251.5	52.19	226.4	42.29	201.2	33.44	176.1	25.63	150.9	18.86	125.8	13.13	100.6	8.45	75.5	4.80
15 °C		251.5	251.5	51.37	226.4	41.63	201.2	32.92	176.1	25.23	150.9	18.57	125.8	12.93	100.6	8.32	75.5	4.73

TC : Total Capacity PI : Power Input
Indoor air temperature conditions : 27.0°C dry-bulb / 19.0°C wet bulb

Heating

Outdoor Unit Dry-Bulb (°C)		Outdoor Unit Wet-Bulb (°C)	Outdoor Unit 100% Heating Capacity (kW)	Compressor + Outdoor Fan Power consumption (kW)															
				100% Capacity		90% Capacity		80% Capacity		70% Capacity		60% Capacity		50% Capacity		40% Capacity		30% Capacity	
				TC	PI	TC	PI	TC	PI	TC	PI	TC	PI	TC	PI	TC	PI	TC	PI
				(kW)	(kW)	(kW)	(kW)	(kW)	(kW)	(kW)	(kW)	(kW)	(kW)	(kW)	(kW)	(kW)	(kW)	(kW)	(kW)
15.0	13.7	272.0	272.0	69.14	244.8	60.95	217.6	53.05	190.4	45.44	163.2	38.12	136.0	31.09	108.8	24.36	81.6	17.91	
13.0	11.8	272.0	272.0	71.17	244.8	62.71	217.6	54.55	190.4	46.70	163.2	39.16	136.0	31.92	108.8	24.99	81.6	18.36	
11.0	9.8	272.0	272.0	73.45	244.8	64.69	217.6	56.24	190.4	48.12	163.2	40.33	136.0	32.85	108.8	25.70	81.6	18.87	
9.0	7.9	272.0	272.0	75.77	244.8	66.69	217.6	57.96	190.4	49.56	163.2	41.51	136.0	33.79	108.8	26.42	81.6	19.38	
7.0	6.0	272.0	272.0	78.25	244.8	68.84	217.6	59.79	190.4	51.10	163.2	42.77	136.0	34.79	108.8	27.18	81.6	19.92	
5.0	4.1	264.1	264.1	78.01	237.6	68.63	211.2	59.61	184.8	50.94	158.4	42.64	132.0	34.69	105.6	27.10	79.2	19.86	
3.0	2.2	256.1	256.1	77.78	230.5	68.42	204.9	59.43	179.3	50.79	153.7	42.51	128.1	34.58	102.4	27.01	76.8	19.80	
0.0	-0.7	244.0	244.0	77.41	219.6	68.10	195.2	59.15	170.8	50.55	146.4	42.31	122.0	34.42	97.6	26.89	73.2	19.71	
-3.0	-3.7	231.4	231.4	77.04	208.3	67.77	185.1	58.86	162.0	50.30	138.8	42.10	115.7	34.25	92.6	26.76	69.4	19.61	
-5.0	-5.6	223.5	223.5	76.80	201.1	67.56	178.8	58.68	156.4	50.15	134.1	41.97	111.7	34.15	89.4	26.67	67.0	19.55	
-7.0	-7.6	215.1	215.1	76.55	193.6	67.34	172.1	58.49	150.6	49.99	129.1	41.83	107.5	34.04	86.0	26.59	64.5	19.49	
-10	-10.5	203.0	203.0	76.19	182.7	67.02	162.4	58.21	142.1	49.75	121.8	41.64	101.5	33.87	81.2	26.46	60.9	19.40	
-14.5	-15.0	184.1	184.1	75.62	165.7	66.53	147.3	57.78	128.9	49.38	110.5	41.33	92.1	33.62	73.6	26.27	55.2	19.25	
-19.5	-20.0	163.2	163.2	75.00	146.9	65.98	130.6	57.30	114.2	48.97	97.9	40.99	81.6	33.35	65.3	26.05	49.0	19.10	

TC : Total Capacity PI : Power Input
Indoor air temperature conditions : 20.0°C dry-bulb

MMY-UP9211HT8P-E (92HP, 257 kW system)

Outdoor Unit Dry-Bulb (°C)		Outdoor Unit 100% Cooling Capacity (kW)	Compressor + Outdoor Fan Power consumption (kW)															
			100% Capacity		90% Capacity		80% Capacity		70% Capacity		60% Capacity		50% Capacity		40% Capacity		30% Capacity	
			TC (kW)	PI (kW)	TC (kW)	PI (kW)	TC (kW)	PI (kW)	TC (kW)	PI (kW)	TC (kW)	PI (kW)	TC (kW)	PI (kW)	TC (kW)	PI (kW)	TC (kW)	PI (kW)
46 °C		201.3	201.3	93.12	181.2	75.44	161.0	59.62	140.9	45.65	120.8	33.55	100.6	23.32	80.5	14.94	60.4	8.42
43 °C		220.8	220.8	94.86	198.7	76.84	176.6	60.72	154.5	46.50	132.5	34.18	110.4	23.75	88.3	15.21	66.2	8.58
41 °C		235.2	235.2	97.25	211.7	78.78	188.1	62.25	164.6	47.67	141.1	35.04	117.6	24.34	94.1	15.60	70.6	8.79
39 °C		243.0	243.0	94.42	218.7	76.49	194.4	60.44	170.1	46.29	145.8	34.02	121.5	23.64	97.2	15.14	72.9	8.54
37 °C		250.3	250.3	91.56	225.2	74.17	200.2	58.61	175.2	44.89	150.2	32.99	125.1	22.92	100.1	14.68	75.1	8.28
35 °C		257.0	257.0	90.58	231.3	71.85	205.6	56.78	179.9	43.48	154.2	31.96	128.5	22.20	102.8	14.22	77.1	8.02
32 °C		257.0	257.0	81.80	231.3	66.26	205.6	52.36	179.9	40.10	154.2	29.47	128.5	20.48	102.8	13.12	77.1	7.40
31 °C		257.0	257.0	75.69	231.3	61.31	205.6	48.45	179.9	37.10	154.2	27.27	128.5	18.95	102.8	12.14	77.1	6.84
30 °C		257.0	257.0	72.88	231.3	59.04	205.6	46.66	179.9	35.73	154.2	26.26	128.5	18.25	102.8	11.69	77.1	6.59
29 °C		257.0	257.0	70.22	231.3	56.89	205.6	44.95	179.9	34.43	154.2	25.30	128.5	17.58	102.8	11.26	77.1	6.35
27 °C		257.0	257.0	65.30	231.3	52.90	205.6	41.80	179.9	32.01	154.2	23.53	128.5	16.35	102.8	10.48	77.1	5.91
25 °C		257.0	257.0	60.82	231.3	49.27	205.6	38.93	179.9	29.82	154.2	21.91	128.5	15.23	102.8	9.76	77.1	5.50
23 °C		257.0	257.0	57.96	231.3	46.95	205.6	37.11	179.9	28.42	154.2	20.89	128.5	14.51	102.8	9.30	77.1	5.25
21 °C		257.0	257.0	56.60	231.3	45.85	205.6	36.24	179.9	27.75	154.2	20.40	128.5	14.17	102.8	9.08	77.1	5.12
20 °C		257.0	257.0	55.99	231.3	45.36	205.6	35.85	179.9	27.45	154.2	20.18	128.5	14.02	102.8	8.99	77.1	5.07
19 °C		257.0	257.0	55.43	231.3	44.91	205.6	35.49	179.9	27.18	154.2	19.98	128.5	13.88	102.8	8.90	77.1	5.02
17 °C		257.0	257.0	54.43	231.3	44.09	205.6	34.85	179.9	26.69	154.2	19.61	128.5	13.63	102.8	8.74	77.1	4.93
15 °C		257.0	257.0	53.57	231.3	43.40	205.6	34.30	179.9	26.27	154.2	19.31	128.5	13.42	102.8	8.60	77.1	4.85

TC : Total Capacity PI : Power Input
Indoor air temperature conditions : 27.0°C dry-bulb / 19.0°C wet bulb

Outdoor Unit Dry-Bulb (°C)		Outdoor Unit Wet-Bulb (°C)	Outdoor Unit 100% Heating Capacity (kW)	Compressor + Outdoor Fan Power consumption (kW)															
				100% Capacity		90% Capacity		80% Capacity		70% Capacity		60% Capacity		50% Capacity		40% Capacity		30% Capacity	
				TC (kW)	PI (kW)	TC (kW)	PI (kW)	TC (kW)	PI (kW)	TC (kW)	PI (kW)	TC (kW)	PI (kW)	TC (kW)	PI (kW)	TC (kW)	PI (kW)	TC (kW)	PI (kW)
15.0	13.7	273.0	273.0	70.95	245.7	62.75	218.4	54.81	191.1	47.11	163.8	39.67	136.5	32.48	109.2	25.54	81.9	18.86	
13.0	11.8	273.0	273.0	72.98	245.7	64.52	218.4	56.32	191.1	48.39	163.8	40.73	136.5	33.33	109.2	26.20	81.9	19.33	
11.0	9.8	273.0	273.0	75.25	245.7	66.49	218.4	58.02	191.1	49.83	163.8	41.91	136.5	34.28	109.2	26.93	81.9	19.85	
9.0	7.9	273.0	273.0	77.55	245.7	68.50	218.4	59.74	191.1	51.28	163.8	43.11	136.5	35.24	109.2	27.66	81.9	20.38	
7.0	6.0	273.0	273.0	80.01	245.7	70.64	218.4	61.57	191.1	52.82	163.8	44.39	136.5	36.26	109.2	28.45	81.9	20.95	
5.0	4.1	265.0	265.0	79.77	238.5	70.42	212.0	61.39	185.5	52.66	159.0	44.25	132.5	36.15	106.0	28.36	79.5	20.88	
3.0	2.2	257.0	257.0	79.52	231.3	70.21	205.6	61.20	179.9	52.50	154.2	44.12	128.5	36.04	102.8	28.27	77.1	20.82	
0.0	-0.7	244.9	244.9	79.15	220.4	69.88	195.9	60.91	171.4	52.26	146.9	43.91	122.4	35.87	97.9	28.14	73.5	20.72	
-3.0	-3.7	232.3	232.3	78.77	209.0	69.54	185.8	60.62	162.6	52.00	139.4	43.70	116.1	35.70	92.9	28.01	69.7	20.62	
-5.0	-5.6	224.3	224.3	78.53	201.9	69.33	179.4	60.43	157.0	51.84	134.6	43.56	112.1	35.59	89.7	27.92	67.3	20.56	
-7.0	-7.6	215.9	215.9	78.27	194.3	69.10	172.7	60.23	151.1	51.68	129.5	43.42	107.9	35.47	86.4	27.83	64.8	20.49	
-10	-10.5	203.7	203.7	77.90	183.3	68.77	163.0	59.95	142.6	51.43	122.2	43.22	101.9	35.30	81.5	27.70	61.1	20.39	
-14.5	-15.0	184.8	184.8	77.32	166.3	68.26	147.8	59.51	129.4	51.05	110.9	42.90	92.4	35.04	73.9	27.49	55.4	20.24	
-19.5	-20.0	163.8	163.8	76.68	147.4	67.70	131.0	59.01	114.7	50.63	98.3	42.54	81.9	34.75	65.5	27.26	49.1	20.08	

TC : Total Capacity PI : Power Input
Indoor air temperature conditions : 20.0°C dry-bulb

MMY-UP9411HT8P-E (94HP, 262.5 kW system)

Cooling		Compressor + Outdoor Fan Power consumption (kW)																	
		Outdoor Unit Dry-Bulb (°C)	Outdoor Unit 100% Cooling Capacity (kW)	100% Capacity		90% Capacity		80% Capacity		70% Capacity		60% Capacity		50% Capacity		40% Capacity		30% Capacity	
				TC (kW)	PI (kW)	TC (kW)	PI (kW)	TC (kW)	PI (kW)	TC (kW)	PI (kW)	TC (kW)	PI (kW)	TC (kW)	PI (kW)	TC (kW)	PI (kW)	TC (kW)	PI (kW)
46 °C	205.6	205.6	95.62	185.0	77.47	164.5	61.24	143.9	46.91	123.4	34.50	102.8	24.00	82.2	15.40	61.7	8.72		
43 °C	225.5	225.5	97.39	203.0	78.91	180.4	62.37	157.9	47.78	135.3	35.14	112.8	24.44	90.2	15.68	67.7	8.87		
41 °C	240.2	240.2	99.84	216.2	80.89	192.2	63.94	168.1	48.98	144.1	36.02	120.1	25.05	96.1	16.07	72.1	9.09		
39 °C	248.2	248.2	96.94	223.4	78.54	198.6	62.08	173.7	47.56	148.9	34.97	124.1	24.32	99.3	15.60	74.5	8.83		
37 °C	255.6	255.6	94.00	230.1	76.16	204.5	60.20	178.9	46.12	153.4	33.91	127.8	23.58	102.2	15.13	76.7	8.56		
35 °C	262.5	262.5	93.00	236.3	73.78	210.0	58.32	183.8	44.68	157.5	32.85	131.3	22.84	105.0	14.66	78.8	8.29		
32 °C	262.5	262.5	83.98	236.3	68.05	210.0	53.79	183.8	41.20	157.5	30.30	131.3	21.07	105.0	13.52	78.8	7.65		
31 °C	262.5	262.5	77.71	236.3	62.96	210.0	49.77	183.8	38.13	157.5	28.04	131.3	19.50	105.0	12.52	78.8	7.08		
30 °C	262.5	262.5	74.83	236.3	60.63	210.0	47.93	183.8	36.72	157.5	27.00	131.3	18.78	105.0	12.05	78.8	6.82		
29 °C	262.5	262.5	72.10	236.3	58.42	210.0	46.18	183.8	35.38	157.5	26.02	131.3	18.10	105.0	11.61	78.8	6.57		
27 °C	262.5	262.5	67.05	236.3	54.33	210.0	42.94	183.8	32.90	157.5	24.19	131.3	16.83	105.0	10.80	78.8	6.12		
25 °C	262.5	262.5	62.45	236.3	50.60	210.0	40.00	183.8	30.64	157.5	22.54	131.3	15.68	105.0	10.06	78.8	5.70		
23 °C	262.5	262.5	59.52	236.3	48.23	210.0	38.12	183.8	29.21	157.5	21.48	131.3	14.94	105.0	9.59	78.8	5.43		
21 °C	262.5	262.5	58.12	236.3	47.10	210.0	37.23	183.8	28.52	157.5	20.98	131.3	14.59	105.0	9.37	78.8	5.31		
20 °C	262.5	262.5	57.50	236.3	46.59	210.0	36.83	183.8	28.22	157.5	20.75	131.3	14.44	105.0	9.27	78.8	5.25		
19 °C	262.5	262.5	56.92	236.3	46.12	210.0	36.46	183.8	27.94	157.5	20.55	131.3	14.29	105.0	9.18	78.8	5.20		
17 °C	262.5	262.5	55.89	236.3	45.29	210.0	35.80	183.8	27.43	157.5	20.18	131.3	14.04	105.0	9.01	78.8	5.11		
15 °C	262.5	262.5	55.02	236.3	44.58	210.0	35.24	183.8	27.00	157.5	19.86	131.3	13.82	105.0	8.87	78.8	5.03		

TC : Total Capacity PI : Power Input
Indoor air temperature conditions : 27.0°C dry-bulb / 19.0°C wet bulb

Heating		Compressor + Outdoor Fan Power consumption (kW)																		
		Outdoor Unit Dry-Bulb (°C)	Outdoor Unit Wet-Bulb (°C)	Outdoor Unit 100% Heating Capacity (kW)	100% Capacity		90% Capacity		80% Capacity		70% Capacity		60% Capacity		50% Capacity		40% Capacity		30% Capacity	
					TC (kW)	PI (kW)	TC (kW)	PI (kW)	TC (kW)	PI (kW)	TC (kW)	PI (kW)	TC (kW)	PI (kW)	TC (kW)	PI (kW)	TC (kW)	PI (kW)	TC (kW)	PI (kW)
15.0	13.7	279.0	279.0	72.27	251.1	64.02	223.2	56.01	195.3	48.22	167.4	40.65	139.5	33.31	111.6	26.20	83.7	19.31		
13.0	11.8	279.0	279.0	74.29	251.1	65.80	223.2	57.54	195.3	49.52	167.4	41.73	139.5	34.18	111.6	26.87	83.7	19.80		
11.0	9.8	279.0	279.0	76.56	251.1	67.78	223.2	59.25	195.3	50.97	167.4	42.93	139.5	35.15	111.6	27.62	83.7	20.34		
9.0	7.9	279.0	279.0	78.86	251.1	69.79	223.2	60.98	195.3	52.43	167.4	44.15	139.5	36.13	111.6	28.38	83.7	20.89		
7.0	6.0	279.0	279.0	81.32	251.1	71.93	223.2	62.83	195.3	54.00	167.4	45.45	139.5	37.18	111.6	29.18	83.7	21.47		
5.0	4.1	270.8	270.8	81.07	243.8	71.72	216.7	62.64	189.6	53.83	162.5	45.31	135.4	37.06	108.3	29.09	81.3	21.40		
3.0	2.2	262.7	262.7	80.83	236.4	71.50	210.2	62.44	183.9	53.67	157.6	45.17	131.3	36.95	105.1	29.01	78.8	21.34		
0.0	-0.7	250.2	250.2	80.45	225.2	71.16	200.2	62.15	175.2	53.42	150.1	44.96	125.1	36.78	100.1	28.87	75.1	21.24		
-3.0	-3.7	237.4	237.4	80.06	213.6	70.82	189.9	61.85	166.2	53.16	142.4	44.74	118.7	36.60	94.9	28.73	71.2	21.14		
-5.0	-5.6	229.2	229.2	79.81	206.3	70.60	183.4	61.66	160.4	53.00	137.5	44.60	114.6	36.49	91.7	28.64	68.8	21.07		
-7.0	-7.6	220.6	220.6	79.55	198.6	70.37	176.5	61.46	154.4	52.82	132.4	44.46	110.3	36.37	88.3	28.55	66.2	21.00		
-10	-10.5	208.2	208.2	79.17	187.4	70.04	166.5	61.17	145.7	52.57	124.9	44.25	104.1	36.19	83.3	28.41	62.5	20.90		
-14.5	-15.0	188.9	188.9	78.59	170.0	69.52	151.1	60.72	132.2	52.18	113.3	43.92	94.4	35.93	75.5	28.20	56.7	20.75		
-19.5	-20.0	167.4	167.4	77.94	150.7	68.94	133.9	60.21	117.2	51.75	100.4	43.56	83.7	35.63	67.0	27.97	50.2	20.58		

TC : Total Capacity PI : Power Input
Indoor air temperature conditions : 20.0°C dry-bulb

MMY-UP9611HT8P-E(96HP, 268.0 kW system)

Cooling		Outdoor Unit 100% Cooling Capacity (kW)	Compressor + Outdoor Fan Power consumption (kW)															
			100% Capacity		90% Capacity		80% Capacity		70% Capacity		60% Capacity		50% Capacity		40% Capacity		30% Capacity	
			TC	PI	TC	PI	TC	PI	TC	PI	TC	PI	TC	PI	TC	PI	TC	PI
			(kW)	(kW)	(kW)	(kW)	(kW)	(kW)	(kW)	(kW)	(kW)	(kW)	(kW)	(kW)	(kW)	(kW)	(kW)	(kW)
46 °C	209.9	209.9	99.47	188.9	80.57	167.9	63.66	146.9	48.74	125.9	35.81	105.0	24.87	84.0	15.92	63.0	8.95	
43 °C	230.2	230.2	101.33	207.2	82.08	184.2	64.85	161.2	49.65	138.1	36.48	115.1	25.33	92.1	16.21	69.1	9.12	
41 °C	245.2	245.2	103.88	220.7	84.15	196.2	66.49	171.7	50.90	147.1	37.40	122.6	25.97	98.1	16.62	73.6	9.35	
39 °C	253.4	253.4	100.86	228.1	81.70	202.7	64.55	177.4	49.42	152.0	36.31	126.7	25.22	101.4	16.14	76.0	9.08	
37 °C	261.0	261.0	97.81	234.9	79.23	208.8	62.60	182.7	47.93	156.6	35.21	130.5	24.45	104.4	15.65	78.3	8.80	
35 °C	268.0	268.0	96.76	241.2	76.75	214.4	60.64	187.6	46.43	160.8	34.11	134.0	23.69	107.2	15.16	80.4	8.53	
32 °C	268.0	268.0	87.38	241.2	70.78	214.4	55.92	187.6	42.82	160.8	31.46	134.0	21.84	107.2	13.98	80.4	7.86	
31 °C	268.0	268.0	80.85	241.2	65.49	214.4	51.74	187.6	39.62	160.8	29.11	134.0	20.21	107.2	12.94	80.4	7.28	
30 °C	268.0	268.0	77.85	241.2	63.06	214.4	49.82	187.6	38.15	160.8	28.03	134.0	19.46	107.2	12.46	80.4	7.01	
29 °C	268.0	268.0	75.01	241.2	60.76	214.4	48.01	187.6	36.75	160.8	27.00	134.0	18.75	107.2	12.00	80.4	6.75	
27 °C	268.0	268.0	69.75	241.2	56.49	214.4	44.64	187.6	34.18	160.8	25.11	134.0	17.44	107.2	11.16	80.4	6.28	
25 °C	268.0	268.0	64.96	241.2	52.62	214.4	41.57	187.6	31.83	160.8	23.39	134.0	16.24	107.2	10.39	80.4	5.85	
23 °C	268.0	268.0	61.91	241.2	50.15	214.4	39.62	187.6	30.34	160.8	22.29	134.0	15.48	107.2	9.91	80.4	5.57	
21 °C	268.0	268.0	60.46	241.2	48.97	214.4	38.69	187.6	29.62	160.8	21.76	134.0	15.11	107.2	9.67	80.4	5.44	
20 °C	268.0	268.0	59.81	241.2	48.45	214.4	38.28	187.6	29.31	160.8	21.53	134.0	14.95	107.2	9.57	80.4	5.38	
19 °C	268.0	268.0	59.21	241.2	47.96	214.4	37.89	187.6	29.01	160.8	21.31	134.0	14.80	107.2	9.47	80.4	5.33	
17 °C	268.0	268.0	58.14	241.2	47.09	214.4	37.21	187.6	28.49	160.8	20.93	134.0	14.53	107.2	9.30	80.4	5.23	
15 °C	268.0	268.0	57.22	241.2	46.35	214.4	36.62	187.6	28.04	160.8	20.60	134.0	14.30	107.2	9.16	80.4	5.15	

TC : Total Capacity PI : Power Input
Indoor air temperature conditions : 27.0°C dry-bulb / 19.0°C wet bulb

Heating			Outdoor Unit 100% Heating Capacity (kW)	Compressor + Outdoor Fan Power consumption (kW)															
				100% Capacity		90% Capacity		80% Capacity		70% Capacity		60% Capacity		50% Capacity		40% Capacity		30% Capacity	
				TC	PI	TC	PI	TC	PI	TC	PI	TC	PI	TC	PI	TC	PI	TC	PI
				(kW)	(kW)	(kW)	(kW)	(kW)	(kW)	(kW)	(kW)	(kW)	(kW)	(kW)	(kW)	(kW)	(kW)	(kW)	(kW)
15.0	13.7	280.0	280.0	74.09	252.0	65.83	224.0	57.77	196.0	49.89	168.0	42.20	140.0	34.70	112.0	27.38	84.0	20.26	
13.0	11.8	280.0	280.0	76.10	252.0	67.61	224.0	59.31	196.0	51.20	168.0	43.30	140.0	35.59	112.0	28.08	84.0	20.76	
11.0	9.8	280.0	280.0	78.36	252.0	69.59	224.0	61.02	196.0	52.67	168.0	44.52	140.0	36.58	112.0	28.85	84.0	21.32	
9.0	7.9	280.0	280.0	80.65	252.0	71.59	224.0	62.76	196.0	54.15	168.0	45.76	140.0	37.58	112.0	29.63	84.0	21.89	
7.0	6.0	280.0	280.0	83.08	252.0	73.73	224.0	64.61	196.0	55.72	168.0	47.07	140.0	38.64	112.0	30.45	84.0	22.49	
5.0	4.1	271.8	271.8	82.83	244.6	73.51	217.5	64.42	190.3	55.56	163.1	46.93	135.9	38.53	108.7	30.36	81.5	22.42	
3.0	2.2	263.6	263.6	82.58	237.3	73.28	210.9	64.22	184.5	55.39	158.2	46.78	131.8	38.41	105.5	30.27	79.1	22.36	
0.0	-0.7	251.1	251.1	82.19	226.0	72.94	200.9	63.92	175.8	55.13	150.7	46.56	125.6	38.23	100.5	30.13	75.3	22.25	
-3.0	-3.7	238.2	238.2	81.79	214.4	72.59	190.6	63.61	166.8	54.86	142.9	46.34	119.1	38.05	95.3	29.98	71.5	22.14	
-5.0	-5.6	230.0	230.0	81.54	207.0	72.36	184.0	63.41	161.0	54.69	138.0	46.20	115.0	37.93	92.0	29.89	69.0	22.07	
-7.0	-7.6	221.4	221.4	81.27	199.3	72.13	177.1	63.21	155.0	54.51	132.9	46.04	110.7	37.80	88.6	29.79	66.4	22.00	
-10	-10.5	208.9	208.9	80.89	188.0	71.78	167.1	62.91	146.2	54.25	125.4	45.83	104.5	37.62	83.6	29.65	62.7	21.90	
-14.5	-15.0	189.5	189.5	80.29	170.6	71.25	151.6	62.44	132.7	53.85	113.7	45.49	94.8	37.35	75.8	29.43	56.9	21.74	
-19.5	-20.0	168.0	168.0	79.62	151.2	70.66	134.4	61.92	117.6	53.41	100.8	45.11	84.0	37.04	67.2	29.19	50.4	21.56	

TC : Total Capacity PI : Power Input
Indoor air temperature conditions : 20.0°C dry-bulb

MMY-UP9811HT8P-E (98HP, 274.5 kW system)

Cooling		Compressor + Outdoor Fan Power consumption (kW)																	
		Outdoor Unit		100% Capacity		90% Capacity		80% Capacity		70% Capacity		60% Capacity		50% Capacity		40% Capacity		30% Capacity	
		Dry-Bulb (°C)	100% Cooling Capacity (kW)	TC (kW)	PI (kW)	TC (kW)	PI (kW)	TC (kW)	PI (kW)	TC (kW)	PI (kW)	TC (kW)	PI (kW)	TC (kW)	PI (kW)	TC (kW)	PI (kW)	TC (kW)	PI (kW)
46 °C	215.0	215.0	100.17	193.5	81.18	172.0	64.19	150.5	49.19	129.0	36.19	107.5	25.17	86.0	16.15	64.5	9.12		
43 °C	235.8	235.8	102.02	212.2	82.68	188.7	65.38	165.1	50.10	141.5	36.85	117.9	25.63	94.3	16.45	70.7	9.29		
41 °C	251.2	251.2	104.58	226.1	84.76	200.9	67.01	175.8	51.35	150.7	37.77	125.6	26.27	100.5	16.86	75.4	9.52		
39 °C	259.5	259.5	101.54	233.6	82.29	207.6	65.07	181.7	49.86	155.7	36.67	129.8	25.51	103.8	16.37	77.9	9.24		
37 °C	267.3	267.3	98.46	240.6	79.80	213.8	63.10	187.1	48.35	160.4	35.56	133.6	24.74	106.9	15.87	80.2	8.96		
35 °C	274.5	274.5	97.46	247.1	77.30	219.6	61.12	192.2	46.84	164.7	34.45	137.3	23.96	109.8	15.37	82.4	8.68		
32 °C	274.5	274.5	87.97	247.1	71.30	219.6	56.37	192.2	43.20	164.7	31.78	137.3	22.10	109.8	14.18	82.4	8.01		
31 °C	274.5	274.5	81.41	247.1	65.98	219.6	52.17	192.2	39.98	164.7	29.41	137.3	20.46	109.8	13.13	82.4	7.41		
30 °C	274.5	274.5	78.39	247.1	63.54	219.6	50.24	192.2	38.50	164.7	28.32	137.3	19.70	109.8	12.64	82.4	7.14		
29 °C	274.5	274.5	75.54	247.1	61.22	219.6	48.41	192.2	37.10	164.7	27.29	137.3	18.98	109.8	12.18	82.4	6.88		
27 °C	274.5	274.5	70.24	247.1	56.93	219.6	45.02	192.2	34.50	164.7	25.38	137.3	17.65	109.8	11.33	82.4	6.40		
25 °C	274.5	274.5	65.43	247.1	53.03	219.6	41.93	192.2	32.13	164.7	23.64	137.3	16.45	109.8	10.55	82.4	5.96		
23 °C	274.5	274.5	62.36	247.1	50.54	219.6	39.97	192.2	30.63	164.7	22.53	137.3	15.68	109.8	10.06	82.4	5.68		
21 °C	274.5	274.5	60.90	247.1	49.36	219.6	39.03	192.2	29.91	164.7	22.01	137.3	15.31	109.8	9.83	82.4	5.55		
20 °C	274.5	274.5	60.25	247.1	48.83	219.6	38.61	192.2	29.59	164.7	21.77	137.3	15.15	109.8	9.72	82.4	5.49		
19 °C	274.5	274.5	59.65	247.1	48.34	219.6	38.23	192.2	29.30	164.7	21.55	137.3	15.00	109.8	9.62	82.4	5.44		
17 °C	274.5	274.5	58.57	247.1	47.47	219.6	37.54	192.2	28.77	164.7	21.16	137.3	14.73	109.8	9.45	82.4	5.34		
15 °C	274.5	274.5	57.65	247.1	46.72	219.6	36.95	192.2	28.32	164.7	20.83	137.3	14.49	109.8	9.30	82.4	5.26		

TC : Total Capacity PI : Power Input
 Indoor air temperature conditions : 27.0°C dry-bulb / 19.0°C wet bulb

Heating			Compressor + Outdoor Fan Power consumption (kW)																	
			Outdoor Unit		100% Capacity		90% Capacity		80% Capacity		70% Capacity		60% Capacity		50% Capacity		40% Capacity		30% Capacity	
			Dry-Bulb (°C)	Wet-Bulb (°C)	100% Heating Capacity (kW)	TC (kW)	PI (kW)	TC (kW)	PI (kW)	TC (kW)	PI (kW)	TC (kW)	PI (kW)	TC (kW)	PI (kW)	TC (kW)	PI (kW)	TC (kW)	PI (kW)	
15.0	13.7	292.5	292.5	73.85	263.3	65.28	234.0	56.98	204.8	48.94	175.5	41.16	146.3	33.64	117.0	26.39	87.8	19.40		
13.0	11.8	292.5	292.5	75.96	263.3	67.13	234.0	58.56	204.8	50.28	175.5	42.27	146.3	34.53	117.0	27.07	87.8	19.89		
11.0	9.8	292.5	292.5	78.34	263.3	69.19	234.0	60.34	204.8	51.78	175.5	43.50	146.3	35.53	117.0	27.84	87.8	20.44		
9.0	7.9	292.5	292.5	80.74	263.3	71.28	234.0	62.14	204.8	53.29	175.5	44.76	146.3	36.53	117.0	28.61	87.8	21.00		
7.0	6.0	292.5	292.5	83.31	263.3	73.52	234.0	64.05	204.8	54.91	175.5	46.09	146.3	37.60	117.0	29.43	87.8	21.59		
5.0	4.1	284.0	284.0	83.06	255.6	73.30	227.2	63.86	198.8	54.74	170.4	45.95	142.0	37.49	113.6	29.34	85.2	21.52		
3.0	2.2	275.4	275.4	82.80	247.9	73.07	220.3	63.66	192.8	54.58	165.2	45.81	137.7	37.37	110.2	29.25	82.6	21.46		
0.0	-0.7	262.4	262.4	82.42	236.1	72.73	209.9	63.37	183.6	54.32	157.4	45.60	131.2	37.20	104.9	29.12	78.7	21.36		
-3.0	-3.7	248.9	248.9	82.02	224.0	72.38	199.1	63.06	174.2	54.06	149.3	45.38	124.4	37.02	99.5	28.97	74.7	21.25		
-5.0	-5.6	240.3	240.3	81.76	216.3	72.16	192.2	62.86	168.2	53.89	144.2	45.24	120.2	36.90	96.1	28.88	72.1	21.19		
-7.0	-7.6	231.3	231.3	81.50	208.2	71.92	185.0	62.66	161.9	53.72	138.8	45.09	115.7	36.78	92.5	28.79	69.4	21.12		
-10	-10.5	218.3	218.3	81.11	196.4	71.58	174.6	62.36	152.8	53.46	131.0	44.88	109.1	36.61	87.3	28.65	65.5	21.02		
-14.5	-15.0	198.0	198.0	80.51	178.2	71.05	158.4	61.90	138.6	53.07	118.8	44.54	99.0	36.34	79.2	28.44	59.4	20.86		
-19.5	-20.0	175.5	175.5	79.85	158.0	70.46	140.4	61.39	122.9	52.63	105.30	44.18	87.8	36.04	70.2	28.21	52.7	20.69		

TC : Total Capacity PI : Power Input
 Indoor air temperature conditions : 20.0°C dry-bulb

MMY-UP10011HT8P-E (100HP, 281.0 kW system)

Cooling		Compressor + Outdoor Fan Power consumption (kW)																	
		Outdoor Unit Dry-Bulb (°C)	Outdoor Unit 100% Cooling Capacity (kW)	100% Capacity		90% Capacity		80% Capacity		70% Capacity		60% Capacity		50% Capacity		40% Capacity		30% Capacity	
				TC	PI	TC	PI	TC	PI	TC	PI	TC	PI	TC	PI	TC	PI	TC	PI
				(kW)	(kW)	(kW)	(kW)	(kW)	(kW)	(kW)	(kW)	(kW)	(kW)	(kW)	(kW)	(kW)	(kW)	(kW)	(kW)
46 °C	220.1	220.1	104.52	198.1	84.66	176.1	66.89	154.1	51.21	132.1	37.63	110.0	26.13	88.0	16.72	66.0	9.41		
43 °C	241.4	241.4	106.46	217.3	86.24	193.1	68.14	169.0	52.17	144.8	38.33	120.7	26.62	96.6	17.03	72.4	9.58		
41 °C	257.1	257.1	109.15	231.4	88.41	205.7	69.85	180.0	53.48	154.3	39.29	128.6	27.29	102.9	17.46	77.1	9.82		
39 °C	265.7	265.7	105.98	239.1	85.84	212.6	67.82	186.0	51.93	159.4	38.15	132.8	26.49	106.3	16.96	79.7	9.54		
37 °C	273.6	273.6	102.77	246.3	83.24	218.9	65.77	191.5	50.36	164.2	37.00	136.8	25.69	109.5	16.44	82.1	9.25		
35 °C	281.0	281.0	101.67	252.9	80.64	224.8	63.71	196.7	48.78	168.6	35.84	140.5	24.89	112.4	15.93	84.3	8.96		
32 °C	281.0	281.0	91.81	252.9	74.36	224.8	58.76	196.7	44.99	168.6	33.05	140.5	22.95	112.4	14.69	84.3	8.26		
31 °C	281.0	281.0	84.95	252.9	68.81	224.8	54.36	196.7	41.62	168.6	30.58	140.5	21.24	112.4	13.59	84.3	7.65		
30 °C	281.0	281.0	81.80	252.9	66.25	224.8	52.35	196.7	40.08	168.6	29.45	140.5	20.45	112.4	13.09	84.3	7.36		
29 °C	281.0	281.0	78.81	252.9	63.84	224.8	50.44	196.7	38.62	168.6	28.37	140.5	19.70	112.4	12.61	84.3	7.09		
27 °C	281.0	281.0	73.28	252.9	59.36	224.8	46.90	196.7	35.91	168.6	26.38	140.5	18.32	112.4	11.72	84.3	6.60		
25 °C	281.0	281.0	68.25	252.9	55.28	224.8	43.68	196.7	33.44	168.6	24.57	140.5	17.06	112.4	10.92	84.3	6.14		
23 °C	281.0	281.0	65.05	252.9	52.69	224.8	41.63	196.7	31.87	168.6	23.42	140.5	16.26	112.4	10.41	84.3	5.85		
21 °C	281.0	281.0	63.52	252.9	51.45	224.8	40.65	196.7	31.13	168.6	22.87	140.5	15.88	112.4	10.16	84.3	5.72		
20 °C	281.0	281.0	62.84	252.9	50.90	224.8	40.22	196.7	30.79	168.6	22.62	140.5	15.71	112.4	10.05	84.3	5.66		
19 °C	281.0	281.0	62.21	252.9	50.39	224.8	39.81	196.7	30.48	168.6	22.39	140.5	15.55	112.4	9.95	84.3	5.60		
17 °C	281.0	281.0	61.08	252.9	49.48	224.8	39.09	196.7	29.93	168.6	21.99	140.5	15.27	112.4	9.77	84.3	5.50		
15 °C	281.0	281.0	60.12	252.9	48.70	224.8	38.48	196.7	29.46	168.6	21.64	140.5	15.03	112.4	9.62	84.3	5.41		

TC : Total Capacity PI : Power Input
Indoor air temperature conditions : 27.0°C dry-bulb / 19.0°C wet bulb

Heating			Compressor + Outdoor Fan Power consumption (kW)																		
			Outdoor Unit Dry-Bulb (°C)	Outdoor Unit Wet-Bulb (°C)	Outdoor Unit 100% Heating Capacity (kW)	100% Capacity		90% Capacity		80% Capacity		70% Capacity		60% Capacity		50% Capacity		40% Capacity		30% Capacity	
						TC	PI	TC	PI	TC	PI	TC	PI	TC	PI	TC	PI	TC	PI	TC	PI
						(kW)	(kW)	(kW)	(kW)	(kW)	(kW)	(kW)	(kW)	(kW)	(kW)	(kW)	(kW)	(kW)	(kW)	(kW)	(kW)
15.0	13.7	300.0	300.0	76.58	270.0	67.57	240.0	58.86	210.0	50.45	180.0	42.34	150.0	34.53	120.0	27.03	90.0	19.82			
13.0	11.8	300.0	300.0	78.81	270.0	69.50	240.0	60.52	210.0	51.85	180.0	43.49	150.0	35.46	120.0	27.73	90.0	20.33			
11.0	9.8	300.0	300.0	81.31	270.0	71.68	240.0	62.38	210.0	53.42	180.0	44.79	150.0	36.49	120.0	28.52	90.0	20.89			
9.0	7.9	300.0	300.0	83.85	270.0	73.89	240.0	64.27	210.0	55.01	180.0	46.09	150.0	37.53	120.0	29.32	90.0	21.47			
7.0	6.0	300.0	300.0	86.57	270.0	76.24	240.0	66.29	210.0	56.70	180.0	47.49	150.0	38.64	120.0	30.17	90.0	22.07			
5.0	4.1	291.2	291.2	86.31	262.1	76.01	233.0	66.09	203.9	56.53	174.7	47.34	145.6	38.53	116.5	30.08	87.4	22.01			
3.0	2.2	282.5	282.5	86.04	254.2	75.78	226.0	65.88	197.7	56.36	169.5	47.20	141.2	38.41	113.0	29.99	84.7	21.94			
0.0	-0.7	269.1	269.1	85.64	242.2	75.43	215.3	65.58	188.4	56.09	161.4	46.98	134.5	38.23	107.6	29.85	80.7	21.84			
-3.0	-3.7	255.2	255.2	85.23	229.7	75.06	204.2	65.26	178.7	55.82	153.1	46.75	127.6	38.05	102.1	29.71	76.6	21.73			
-5.0	-5.6	246.5	246.5	84.96	221.8	74.83	197.2	65.06	172.5	55.65	147.9	46.61	123.2	37.93	98.6	29.61	73.9	21.66			
-7.0	-7.6	237.2	237.2	84.69	213.5	74.58	189.8	64.84	166.1	55.47	142.3	46.45	118.6	37.80	94.9	29.52	71.2	21.59			
-10	-10.5	223.8	223.8	84.29	201.5	74.23	179.1	64.54	156.7	55.21	134.3	46.23	111.9	37.63	89.5	29.38	67.2	21.49			
-14.5	-15.0	203.1	203.1	83.66	182.8	73.68	162.5	64.06	142.2	54.80	121.8	45.89	101.5	37.35	81.2	29.16	60.9	21.33			
-19.5	-20.0	180.0	180.0	82.97	162.0	73.07	144.0	63.53	126.0	54.34	108.0	45.51	90.0	37.04	72.0	28.92	54.0	21.16			

TC : Total Capacity PI : Power Input
Indoor air temperature conditions : 20.0°C dry-bulb

MMY-UP10211HT8P-E (102HP, 286.0 kW system)

Outdoor Unit Dry-Bulb (°C)		Outdoor Unit 100% Cooling Capacity (kW)	Compressor + Outdoor Fan Power consumption (kW)															
			100% Capacity		90% Capacity		80% Capacity		70% Capacity		60% Capacity		50% Capacity		40% Capacity		30% Capacity	
			TC	PI	TC	PI	TC	PI	TC	PI	TC	PI	TC	PI	TC	PI	TC	PI
		(kW)		(kW)		(kW)		(kW)		(kW)		(kW)		(kW)		(kW)		
46 °C		224.0	224.0	101.73	201.6	82.42	179.2	65.14	156.8	49.89	134.4	36.68	112.01	25.50	89.60	16.35	67.20	9.24
43 °C		245.7	245.7	103.62	221.1	83.95	196.6	66.35	172.0	50.82	147.4	37.36	122.8	25.97	98.28	16.65	73.71	9.41
41 °C		261.7	261.7	106.23	235.5	86.06	209.4	68.02	183.2	52.09	157.0	38.30	130.9	26.62	104.68	17.07	78.51	9.64
39 °C		270.4	270.4	103.14	243.4	83.56	216.3	66.04	189.3	50.58	162.3	37.18	135.2	25.85	108.17	16.57	81.13	9.36
37 °C		278.5	278.5	100.02	250.6	81.03	222.8	64.04	194.9	49.05	167.1	36.06	139.2	25.06	111.40	16.07	83.55	9.07
35 °C		286.0	286.0	98.95	257.4	78.49	228.8	62.04	200.2	47.52	171.6	34.93	143.0	24.28	114.4	15.57	85.80	8.79
32 °C		286.0	286.0	89.35	257.4	72.39	228.8	57.21	200.2	43.82	171.6	32.22	143.0	22.39	114.4	14.36	85.80	8.11
31 °C		286.0	286.0	82.68	257.4	66.98	228.8	52.94	200.2	40.55	171.6	29.81	143.0	20.72	114.4	13.29	85.80	7.51
30 °C		286.0	286.0	79.61	257.4	64.50	228.8	50.98	200.2	39.05	171.6	28.71	143.0	19.96	114.4	12.80	85.80	7.23
29 °C		286.0	286.0	76.71	257.4	62.15	228.8	49.12	200.2	37.62	171.6	27.66	143.0	19.23	114.4	12.33	85.80	6.97
27 °C		286.0	286.0	71.33	257.4	57.79	228.8	45.68	200.2	34.99	171.6	25.72	143.0	17.88	114.4	11.47	85.80	6.48
25 °C		286.0	286.0	66.44	257.4	53.83	228.8	42.54	200.2	32.59	171.6	23.96	143.0	16.66	114.4	10.68	85.80	6.04
23 °C		286.0	286.0	63.32	257.4	51.30	228.8	40.55	200.2	31.06	171.6	22.84	143.0	15.88	114.4	10.18	85.80	5.76
21 °C		286.0	286.0	61.84	257.4	50.10	228.8	39.60	200.2	30.33	171.6	22.30	143.0	15.51	114.4	9.95	85.80	5.62
20 °C		286.0	286.0	61.17	257.4	49.56	228.8	39.17	200.2	30.01	171.6	22.06	143.0	15.34	114.4	9.84	85.80	5.56
19 °C		286.0	286.0	60.56	257.4	49.06	228.8	38.78	200.2	29.71	171.6	21.84	143.0	15.19	114.4	9.74	85.80	5.51
17 °C		286.0	286.0	59.46	257.4	48.18	228.8	38.08	200.2	29.17	171.6	21.45	143.0	14.91	114.4	9.57	85.80	5.41
15 °C		286.0	286.0	58.53	257.4	47.42	228.8	37.48	200.2	28.71	171.6	21.11	143.0	14.68	114.4	9.42	85.80	5.32

TC : Total Capacity PI : Power Input
Indoor air temperature conditions : 27.0°C dry-bulb / 19.0°C wet bulb

Outdoor Unit Dry-Bulb (°C)			Outdoor Unit 100% Heating Capacity (kW)	Compressor + Outdoor Fan Power consumption (kW)															
				100% Capacity		90% Capacity		80% Capacity		70% Capacity		60% Capacity		50% Capacity		40% Capacity		30% Capacity	
				TC	PI	TC	PI	TC	PI	TC	PI	TC	PI	TC	PI	TC	PI	TC	PI
			(kW)		(kW)		(kW)		(kW)		(kW)		(kW)		(kW)		(kW)		
15.0	13.7	311.0	311.0	78.33	279.9	68.77	248.8	59.61	217.7	50.85	186.6	42.48	155.5	34.51	124.4	26.94	93.3	19.77	
13.0	11.8	311.0	311.0	80.72	279.9	70.83	248.8	61.36	217.7	52.30	186.6	43.67	155.5	35.45	124.4	27.65	93.3	20.27	
11.0	9.8	311.0	311.0	83.41	279.9	73.14	248.8	63.32	217.7	53.94	186.6	45.00	155.5	36.50	124.4	28.45	93.3	20.83	
9.0	7.9	311.0	311.0	86.14	279.9	75.50	248.8	65.32	217.7	55.60	186.6	46.35	155.5	37.57	124.4	29.25	93.3	21.40	
7.0	6.0	311.0	311.0	89.07	279.9	78.01	248.8	67.45	217.7	57.38	186.6	47.80	155.5	38.71	124.4	30.11	93.3	22.00	
5.0	4.1	301.9	301.9	88.80	271.7	77.78	241.5	67.25	211.3	57.20	181.1	47.65	151.0	38.59	120.8	30.02	90.6	21.94	
3.0	2.2	292.8	292.8	88.53	263.5	77.54	234.3	67.04	205.0	57.03	175.7	47.51	146.4	38.47	117.1	29.93	87.8	21.87	
0.0	-0.7	278.9	278.9	88.12	251.1	77.18	223.2	66.73	195.3	56.76	167.4	47.29	139.5	38.29	111.6	29.79	83.7	21.77	
-3.0	-3.7	264.6	264.6	87.69	238.1	76.80	211.7	66.40	185.2	56.49	158.8	47.06	132.3	38.11	105.8	29.64	79.4	21.66	
-5.0	-5.6	255.5	255.5	87.42	230.0	76.57	204.4	66.20	178.9	56.31	153.3	46.91	127.8	37.99	102.2	29.55	76.7	21.60	
-7.0	-7.6	245.9	245.9	87.13	221.3	76.32	196.7	65.98	172.2	56.13	147.6	46.76	123.0	37.87	98.4	29.46	73.8	21.52	
-10	-10.5	232.1	232.1	86.72	208.8	75.96	185.6	65.67	162.4	55.86	139.2	46.54	116.0	37.69	92.8	29.32	69.6	21.42	
-14.5	-15.0	210.5	210.5	86.08	189.5	75.39	168.4	65.19	147.4	55.45	126.3	46.19	105.3	37.41	84.2	29.10	63.2	21.26	
-19.5	-20.0	186.6	186.6	85.37	167.9	74.77	149.3	64.65	130.6	54.99	112.0	45.81	93.3	37.10	74.6	28.86	56.0	21.09	

TC : Total Capacity PI : Power Input
Indoor air temperature conditions : 20.0°C dry-bulb

MMY-UP10411HT8P-E (104HP, 290.5 kW system)

Cooling		Compressor + Outdoor Fan Power consumption (kW)																	
		Outdoor Unit Dry-Bulb (°C)	Outdoor Unit 100% Cooling Capacity (kW)	100% Capacity		90% Capacity		80% Capacity		70% Capacity		60% Capacity		50% Capacity		40% Capacity		30% Capacity	
				TC (kW)	PI (kW)	TC (kW)	PI (kW)	TC (kW)	PI (kW)	TC (kW)	PI (kW)	TC (kW)	PI (kW)	TC (kW)	PI (kW)	TC (kW)	PI (kW)	TC (kW)	PI (kW)
46 °C	227.5	227.5	103.73	204.8	84.08	182.0	66.49	159.3	50.96	136.5	37.50	113.8	26.10	91.0	16.76	68.3	9.49		
43 °C	249.6	249.6	105.65	224.6	85.63	199.6	67.71	174.7	51.90	149.7	38.19	124.8	26.57	99.8	17.06	74.9	9.66		
41 °C	265.8	265.8	108.30	239.2	87.77	212.7	69.41	186.1	53.19	159.5	39.14	132.9	27.23	106.3	17.49	79.7	9.89		
39 °C	274.7	274.7	105.15	247.2	85.22	219.7	67.39	192.3	51.65	164.8	38.00	137.3	26.44	109.9	16.98	82.4	9.61		
37 °C	282.9	282.9	101.96	254.6	82.64	226.3	65.35	198.0	50.08	169.7	36.85	141.4	25.64	113.2	16.46	84.9	9.32		
35 °C	290.5	290.5	100.92	261.5	80.06	232.4	63.31	203.4	48.52	174.3	35.70	145.3	24.84	116.2	15.95	87.2	9.02		
32 °C	290.5	290.5	91.10	261.5	73.84	232.4	58.39	203.4	44.75	174.3	32.93	145.3	22.91	116.2	14.71	87.2	8.33		
31 °C	290.5	290.5	84.30	261.5	68.33	232.4	54.03	203.4	41.42	174.3	30.47	145.3	21.21	116.2	13.62	87.2	7.71		
30 °C	290.5	290.5	81.18	261.5	65.80	232.4	52.03	203.4	39.88	174.3	29.35	145.3	20.42	116.2	13.12	87.2	7.42		
29 °C	290.5	290.5	78.22	261.5	63.40	232.4	50.14	203.4	38.43	174.3	28.28	145.3	19.68	116.2	12.64	87.2	7.16		
27 °C	290.5	290.5	72.74	261.5	58.96	232.4	46.63	203.4	35.74	174.3	26.30	145.3	18.30	116.2	11.76	87.2	6.66		
25 °C	290.5	290.5	67.76	261.5	54.92	232.4	43.43	203.4	33.29	174.3	24.50	145.3	17.05	116.2	10.95	87.2	6.20		
23 °C	290.5	290.5	64.58	261.5	52.35	232.4	41.40	203.4	31.73	174.3	23.35	145.3	16.25	116.2	10.44	87.2	5.91		
21 °C	290.5	290.5	63.07	261.5	51.12	232.4	40.43	203.4	30.99	174.3	22.81	145.3	15.88	116.2	10.20	87.2	5.78		
20 °C	290.5	290.5	62.40	261.5	50.58	232.4	40.00	203.4	30.66	174.3	22.56	145.3	15.71	116.2	10.09	87.2	5.72		
19 °C	290.5	290.5	61.77	261.5	50.07	232.4	39.60	203.4	30.35	174.3	22.34	145.3	15.55	116.2	9.99	87.2	5.66		
17 °C	290.5	290.5	60.66	261.5	49.17	232.4	38.88	203.4	29.81	174.3	21.94	145.3	15.27	116.2	9.81	87.2	5.56		
15 °C	290.5	290.5	59.70	261.5	48.40	232.4	38.27	203.4	29.34	174.3	21.59	145.3	15.03	116.2	9.66	87.2	5.47		

TC : Total Capacity PI : Power Input
 Indoor air temperature conditions : 27.0°C dry-bulb / 19.0°C wet bulb

Heating			Compressor + Outdoor Fan Power consumption (kW)																		
			Outdoor Unit Dry-Bulb (°C)	Outdoor Unit Wet-Bulb (°C)	Outdoor Unit 100% Heating Capacity (kW)	100% Capacity		90% Capacity		80% Capacity		70% Capacity		60% Capacity		50% Capacity		40% Capacity		30% Capacity	
						TC (kW)	PI (kW)	TC (kW)	PI (kW)	TC (kW)	PI (kW)	TC (kW)	PI (kW)	TC (kW)	PI (kW)	TC (kW)	PI (kW)	TC (kW)	PI (kW)	TC (kW)	PI (kW)
15.0	13.7	310.5	310.5	78.73	279.5	69.57	248.4	60.69	217.4	52.12	186.3	43.83	155.3	35.84	124.2	28.15	93.2	20.75			
13.0	11.8	310.5	310.5	81.00	279.5	71.54	248.4	62.39	217.4	53.54	186.3	45.01	155.3	36.79	124.2	28.87	93.2	21.27			
11.0	9.8	310.5	310.5	83.54	279.5	73.75	248.4	64.28	217.4	55.14	186.3	46.33	155.3	37.84	124.2	29.68	93.2	21.85			
9.0	7.9	310.5	310.5	86.12	279.5	75.99	248.4	66.20	217.4	56.76	186.3	47.66	155.3	38.91	124.2	30.50	93.2	22.44			
7.0	6.0	310.5	310.5	88.88	279.5	78.38	248.4	68.25	217.4	58.49	186.3	49.08	155.3	40.05	124.2	31.37	93.2	23.06			
5.0	4.1	301.4	301.4	88.61	271.3	78.15	241.1	68.05	211.0	58.31	180.9	48.94	150.7	39.92	120.6	31.28	90.4	22.99			
3.0	2.2	292.4	292.4	88.34	263.1	77.91	233.9	67.84	204.6	58.13	175.4	48.79	146.2	39.80	116.9	31.18	87.7	22.92			
0.0	-0.7	278.5	278.5	87.93	250.6	77.55	222.8	67.52	194.9	57.86	167.1	48.56	139.2	39.62	111.4	31.04	83.5	22.81			
-3.0	-3.7	264.2	264.2	87.50	237.7	77.17	211.3	67.20	184.9	57.58	158.5	48.32	132.1	39.43	105.7	30.89	79.2	22.70			
-5.0	-5.6	255.1	255.1	87.23	229.6	76.93	204.1	66.99	178.6	57.40	153.1	48.17	127.5	39.30	102.0	30.79	76.5	22.63			
-7.0	-7.6	245.5	245.5	86.95	221.0	76.68	196.4	66.77	171.9	57.22	147.3	48.02	122.8	39.18	98.2	30.69	73.7	22.56			
-10	-10.5	231.7	231.7	86.53	208.5	76.32	185.3	66.45	162.2	56.94	139.0	47.79	115.8	38.99	92.7	30.54	69.5	22.45			
-14.5	-15.0	210.2	210.2	85.89	189.2	75.75	168.1	65.96	147.1	56.52	126.1	47.44	105.1	38.70	84.1	30.32	63.1	22.29			
-19.5	-20.0	186.3	186.3	85.18	167.7	75.12	149.0	65.42	130.4	56.05	111.8	47.04	93.2	38.38	74.5	30.07	55.9	22.10			

TC : Total Capacity PI : Power Input
 Indoor air temperature conditions : 20.0°C dry-bulb

MMY-UP10611HT8P-E (106HP, 297.0 kW system)

Cooling		Compressor + Outdoor Fan Power consumption (kW)															
Outdoor Unit Dry-Bulb (°C)	Outdoor Unit 100% Cooling Capacity (kW)	100% Capacity		90% Capacity		80% Capacity		70% Capacity		60% Capacity		50% Capacity		40% Capacity		30% Capacity	
		TC	PI	TC	PI	TC	PI	TC	PI	TC	PI	TC	PI	TC	PI	TC	PI
		(kW)	(kW)	(kW)	(kW)	(kW)	(kW)	(kW)	(kW)	(kW)	(kW)	(kW)	(kW)	(kW)	(kW)	(kW)	(kW)
46 °C	232.6	232.6	108.08	209.4	87.55	186.1	69.19	162.8	52.98	139.6	38.94	116.3	27.05	93.1	17.33	69.8	9.77
43 °C	255.1	255.1	110.09	229.6	89.18	204.1	70.47	178.6	53.97	153.1	39.66	127.6	27.56	102.1	17.65	76.5	9.95
41 °C	271.8	271.8	112.86	244.6	91.43	217.4	72.25	190.2	55.33	163.1	40.66	135.9	28.25	108.7	18.09	81.5	10.20
39 °C	280.8	280.8	109.58	252.7	88.77	224.7	70.15	196.6	53.72	168.5	39.48	140.4	27.43	112.3	17.57	84.2	9.90
37 °C	289.2	289.2	106.27	260.3	86.08	231.4	68.02	202.4	52.09	173.5	38.28	144.6	26.60	115.7	17.04	86.8	9.60
35 °C	297.0	297.0	105.13	267.3	83.39	237.6	65.90	207.9	50.46	178.2	37.08	148.5	25.76	118.8	16.50	89.1	9.30
32 °C	297.0	297.0	94.93	267.3	76.90	237.6	60.77	207.9	46.54	178.2	34.20	148.5	23.76	118.8	15.22	89.1	8.58
31 °C	297.0	297.0	87.84	267.3	71.16	237.6	56.23	207.9	43.06	178.2	31.65	148.5	21.99	118.8	14.08	89.1	7.94
30 °C	297.0	297.0	84.58	267.3	68.52	237.6	54.15	207.9	41.46	178.2	30.47	148.5	21.17	118.8	13.56	89.1	7.64
29 °C	297.0	297.0	81.50	267.3	66.02	237.6	52.17	207.9	39.95	178.2	29.36	148.5	20.40	118.8	13.07	89.1	7.37
27 °C	297.0	297.0	75.78	267.3	61.39	237.6	48.51	207.9	37.15	178.2	27.30	148.5	18.97	118.8	12.15	89.1	6.85
25 °C	297.0	297.0	70.58	267.3	57.18	237.6	45.18	207.9	34.60	178.2	25.43	148.5	17.67	118.8	11.32	89.1	6.38
23 °C	297.0	297.0	67.27	267.3	54.49	237.6	43.06	207.9	32.98	178.2	24.24	148.5	16.84	118.8	10.79	89.1	6.08
21 °C	297.0	297.0	65.69	267.3	53.22	237.6	42.05	207.9	32.20	178.2	23.67	148.5	16.45	118.8	10.54	89.1	5.94
20 °C	297.0	297.0	64.99	267.3	52.65	237.6	41.60	207.9	31.86	178.2	23.42	148.5	16.27	118.8	10.42	89.1	5.88
19 °C	297.0	297.0	64.33	267.3	52.12	237.6	41.18	207.9	31.54	178.2	23.18	148.5	16.11	118.8	10.32	89.1	5.82
17 °C	297.0	297.0	63.17	267.3	51.17	237.6	40.44	207.9	30.97	178.2	22.76	148.5	15.82	118.8	10.13	89.1	5.71
15 °C	297.0	297.0	62.17	267.3	50.37	237.6	39.80	207.9	30.48	178.2	22.40	148.5	15.57	118.8	9.97	89.1	5.62

TC : Total Capacity PI : Power Input
Indoor air temperature conditions : 27.0°C dry-bulb / 19.0°C wet bulb

Heating		Compressor + Outdoor Fan Power consumption (kW)																
Outdoor Unit Dry-Bulb (°C)	Outdoor Unit Wet-Bulb (°C)	Outdoor Unit 100% Heating Capacity (kW)	100% Capacity		90% Capacity		80% Capacity		70% Capacity		60% Capacity		50% Capacity		40% Capacity		30% Capacity	
			TC	PI	TC	PI	TC	PI	TC	PI	TC	PI	TC	PI	TC	PI	TC	PI
			(kW)	(kW)	(kW)	(kW)	(kW)	(kW)	(kW)	(kW)	(kW)	(kW)	(kW)	(kW)	(kW)	(kW)	(kW)	(kW)
15.0	13.7	318.0	318.0	81.46	286.2	71.85	254.4	62.57	222.6	53.63	190.8	45.01	159.0	36.73	127.2	28.79	95.4	21.17
13.0	11.8	318.0	318.0	83.84	286.2	73.92	254.4	64.34	222.6	55.12	190.8	46.24	159.0	37.71	127.2	29.53	95.4	21.71
11.0	9.8	318.0	318.0	86.52	286.2	76.24	254.4	66.33	222.6	56.78	190.8	47.61	159.0	38.81	127.2	30.37	95.4	22.30
9.0	7.9	318.0	318.0	89.24	286.2	78.59	254.4	68.34	222.6	58.47	190.8	49.00	159.0	39.91	127.2	31.22	95.4	22.91
7.0	6.0	318.0	318.0	92.14	286.2	81.11	254.4	70.49	222.6	60.28	190.8	50.48	159.0	41.09	127.2	32.11	95.4	23.55
5.0	4.1	308.7	308.7	91.86	277.8	80.86	247.0	70.27	216.1	60.10	185.2	50.33	154.4	40.97	123.5	32.02	92.6	23.48
3.0	2.2	299.4	299.4	91.58	269.5	80.62	239.5	70.06	209.6	59.91	179.6	50.17	149.7	40.84	119.8	31.92	89.8	23.41
0.0	-0.7	285.2	285.2	91.15	256.7	80.24	228.2	69.73	199.7	59.63	171.1	49.94	142.6	40.65	114.1	31.77	85.6	23.30
-3.0	-3.7	270.5	270.5	90.71	243.5	79.85	216.4	69.39	189.4	59.34	162.3	49.70	135.3	40.45	108.2	31.62	81.2	23.18
-5.0	-5.6	261.3	261.3	90.43	235.1	79.60	209.0	69.18	182.9	59.16	156.8	49.54	130.6	40.33	104.5	31.52	78.4	23.11
-7.0	-7.6	251.5	251.5	90.14	226.3	79.34	201.2	68.95	176.0	58.97	150.9	49.38	125.73	40.20	100.6	31.42	75.4	23.04
-10	-10.5	237.3	237.3	89.71	213.6	78.97	189.8	68.63	166.1	58.69	142.4	49.15	118.64	40.01	94.9	31.27	71.2	22.93
-14.5	-15.0	215.3	215.3	89.05	193.7	78.38	172.2	68.12	150.7	58.25	129.2	48.78	107.63	39.71	86.1	31.04	64.6	22.76
-19.5	-20.0	190.8	190.8	88.31	171.7	77.74	152.6	67.56	133.6	57.77	114.5	48.38	95.40	39.38	76.3	30.78	57.2	22.57

TC : Total Capacity PI : Power Input
Indoor air temperature conditions : 20.0°C dry-bulb

MMY-UP10811HT8P-E (108HP, 301.5 kW system)

Cooling		Compressor + Outdoor Fan Power consumption (kW)															
		100% Capacity		90% Capacity		80% Capacity		70% Capacity		60% Capacity		50% Capacity		40% Capacity		30% Capacity	
		TC	PI	TC	PI	TC	PI	TC	PI	TC	PI	TC	PI	TC	PI	TC	PI
Outdoor Unit Dry-Bulb (°C)	Outdoor Unit 100% Cooling Capacity (kW)	(kW)	(kW)	(kW)	(kW)	(kW)	(kW)	(kW)	(kW)	(kW)	(kW)	(kW)	(kW)	(kW)	(kW)	(kW)	
46 °C	236.2	236.2	110.08	212.5	89.21	188.9	70.54	165.3	54.05	141.7	39.76	118.1	27.65	94.5	17.74	70.8	10.02
43 °C	259.0	259.0	112.12	233.1	90.86	207.2	71.84	181.3	55.05	155.4	40.49	129.5	28.16	103.6	18.06	77.7	10.20
41 °C	275.9	275.9	114.93	248.3	93.14	220.7	73.64	193.1	56.43	165.5	41.50	137.9	28.86	110.4	18.51	82.8	10.45
39 °C	285.1	285.1	111.59	256.6	90.44	228.1	71.50	199.6	54.79	171.0	40.29	142.5	28.02	114.0	17.98	85.5	10.15
37 °C	293.6	293.6	108.21	264.2	87.70	234.9	69.33	205.5	53.13	176.2	39.07	146.8	27.17	117.4	17.43	88.1	9.84
35 °C	301.5	301.5	107.10	271.4	84.95	241.2	67.17	211.1	51.46	180.9	37.85	150.8	26.32	120.6	16.89	90.5	9.53
32 °C	301.5	301.5	96.68	271.4	78.35	241.2	61.95	211.1	47.47	180.9	34.91	150.8	24.28	120.6	15.58	90.5	8.79
31 °C	301.5	301.5	89.47	271.4	72.50	241.2	57.32	211.1	43.93	180.9	32.31	150.8	22.47	120.6	14.42	90.5	8.14
30 °C	301.5	301.5	86.15	271.4	69.82	241.2	55.20	211.1	42.30	180.9	31.11	150.8	21.64	120.6	13.88	90.5	7.84
29 °C	301.5	301.5	83.01	271.4	67.28	241.2	53.19	211.1	40.76	180.9	29.98	150.8	20.85	120.6	13.38	90.5	7.55
27 °C	301.5	301.5	77.19	271.4	62.56	241.2	49.46	211.1	37.90	180.9	27.88	150.8	19.39	120.6	12.44	90.5	7.03
25 °C	301.5	301.5	71.90	271.4	58.27	241.2	46.07	211.1	35.31	180.9	25.97	150.8	18.06	120.6	11.59	90.5	6.55
23 °C	301.5	301.5	68.53	271.4	55.54	241.2	43.91	211.1	33.65	180.9	24.75	150.8	17.22	120.6	11.05	90.5	6.24
21 °C	301.5	301.5	66.93	271.4	54.24	241.2	42.89	211.1	32.87	180.9	24.17	150.8	16.82	120.6	10.79	90.5	6.09
20 °C	301.5	301.5	66.21	271.4	53.66	241.2	42.43	211.1	32.51	180.9	23.92	150.8	16.64	120.6	10.67	90.5	6.03
19 °C	301.5	301.5	65.55	271.4	53.12	241.2	42.00	211.1	32.19	180.9	23.68	150.8	16.47	120.6	10.57	90.5	5.97
17 °C	301.5	301.5	64.36	271.4	52.16	241.2	41.25	211.1	31.61	180.9	23.25	150.8	16.17	120.6	10.38	90.5	5.86
15 °C	301.5	301.5	63.35	271.4	51.34	241.2	40.60	211.1	31.11	180.9	22.89	150.8	15.92	120.6	10.22	90.5	5.77

TC : Total Capacity PI : Power Input
Indoor air temperature conditions : 27.0°C dry-bulb / 19.0°C wet bulb

Heating		Compressor + Outdoor Fan Power consumption (kW)																
		100% Capacity		90% Capacity		80% Capacity		70% Capacity		60% Capacity		50% Capacity		40% Capacity		30% Capacity		
		TC	PI	TC	PI	TC	PI	TC	PI	TC	PI	TC	PI	TC	PI	TC	PI	
Outdoor Unit Dry-Bulb (°C)	Outdoor Unit Wet-Bulb (°C)	Outdoor Unit 100% Heating Capacity (kW)	(kW)	(kW)	(kW)	(kW)	(kW)	(kW)	(kW)	(kW)	(kW)	(kW)	(kW)	(kW)	(kW)	(kW)	(kW)	
15.0	13.7	317.5	317.5	81.86	285.8	72.65	254.0	63.66	222.3	54.90	190.5	46.36	158.8	38.06	127.0	29.99	95.3	22.15
13.0	11.8	317.5	317.5	84.12	285.8	74.63	254.0	65.37	222.3	56.35	190.5	47.58	158.8	39.05	127.0	30.75	95.3	22.70
11.0	9.8	317.5	317.5	86.66	285.8	76.84	254.0	67.29	222.3	57.98	190.5	48.94	158.8	40.14	127.0	31.61	95.3	23.32
9.0	7.9	317.5	317.5	89.22	285.8	79.09	254.0	69.23	222.3	59.63	190.5	50.31	158.8	41.25	127.0	32.46	95.3	23.95
7.0	6.0	317.5	317.5	91.95	285.8	81.48	254.0	71.29	222.3	61.39	190.5	51.77	158.8	42.43	127.0	33.38	95.3	24.61
5.0	4.1	308.2	308.2	91.67	277.4	81.23	246.6	71.08	215.8	61.20	184.9	51.61	154.1	42.30	123.3	33.28	92.5	24.53
3.0	2.2	298.9	298.9	91.39	269.0	80.98	239.2	70.86	209.3	61.01	179.4	51.45	149.5	42.17	119.6	33.17	89.7	24.46
0.0	-0.7	284.8	284.8	90.97	256.3	80.61	227.8	70.53	199.3	60.73	170.9	51.21	142.4	41.98	113.9	33.02	85.4	24.34
-3.0	-3.7	270.1	270.1	90.52	243.1	80.22	216.1	70.19	189.1	60.44	162.1	50.96	135.1	41.77	108.0	32.86	81.0	24.23
-5.0	-5.6	260.8	260.8	90.24	234.8	79.97	208.7	69.97	182.6	60.25	156.5	50.81	130.4	41.64	104.3	32.76	78.3	24.15
-7.0	-7.6	251.1	251.1	89.95	226.0	79.71	200.9	69.74	175.7	60.05	150.6	50.64	125.5	41.51	100.4	32.65	75.3	24.07
-10	-10.5	236.9	236.9	89.52	213.2	79.33	189.5	69.41	165.8	59.77	142.1	50.40	118.5	41.31	94.8	32.50	71.1	23.96
-14.5	-15.0	214.9	214.9	88.86	193.4	78.74	171.9	68.90	150.4	59.33	129.0	50.03	107.5	41.00	86.0	32.26	64.5	23.78
-19.5	-20.0	190.5	190.5	88.13	171.5	78.09	152.4	68.33	133.4	58.83	114.3	49.61	95.3	40.67	76.2	31.99	57.2	23.58

TC : Total Capacity PI : Power Input
Indoor air temperature conditions : 20.0°C dry-bulb

MMY-UP11011HT8P-E (110HP, 308.0 kW system)

Outdoor Unit Dry-Bulb (°C)		Outdoor Unit 100% Cooling Capacity (kW)	Compressor + Outdoor Fan Power consumption (kW)															
			100% Capacity		90% Capacity		80% Capacity		70% Capacity		60% Capacity		50% Capacity		40% Capacity		30% Capacity	
			TC (kW)	PI (kW)	TC (kW)	PI (kW)	TC (kW)	PI (kW)	TC (kW)	PI (kW)	TC (kW)	PI (kW)	TC (kW)	PI (kW)	TC (kW)	PI (kW)	TC (kW)	PI (kW)
46 °C	241.2	241.2	114.43	217.1	92.69	193.0	73.23	168.9	56.07	144.7	41.19	120.6	28.61	96.5	18.31	72.4	10.30	
43 °C	264.6	264.6	116.56	238.1	94.42	211.7	74.60	185.2	57.12	158.8	41.96	132.3	29.14	105.8	18.65	79.4	10.49	
41 °C	281.8	281.8	119.50	253.7	96.80	225.5	76.48	197.3	58.56	169.1	43.02	140.9	29.88	112.7	19.12	84.6	10.76	
39 °C	291.2	291.2	116.03	262.1	93.98	233.0	74.26	203.9	56.85	174.7	41.77	145.6	29.01	116.5	18.56	87.4	10.44	
37 °C	299.9	299.9	112.51	269.9	91.14	239.9	72.01	209.9	55.13	180.0	40.50	150.0	28.13	120.0	18.00	90.0	10.13	
35 °C	308.0	308.0	111.31	277.2	88.29	246.4	69.76	215.6	53.41	184.8	39.24	154.0	27.25	123.2	17.44	92.4	9.81	
32 °C	308.0	308.0	100.52	277.2	81.42	246.4	64.33	215.6	49.25	184.8	36.19	154.0	25.13	123.2	16.08	92.4	9.05	
31 °C	308.0	308.0	93.00	277.2	75.33	246.4	59.52	215.6	45.57	184.8	33.48	154.0	23.25	123.2	14.88	92.4	8.37	
30 °C	308.0	308.0	89.55	277.2	72.54	246.4	57.31	215.6	43.88	184.8	32.24	154.0	22.39	123.2	14.33	92.4	8.06	
29 °C	308.0	308.0	86.29	277.2	69.89	246.4	55.22	215.6	42.28	184.8	31.06	154.0	21.57	123.2	13.81	92.4	7.77	
27 °C	308.0	308.0	80.23	277.2	64.99	246.4	51.35	215.6	39.31	184.8	28.88	154.0	20.06	123.2	12.84	92.4	7.22	
25 °C	308.0	308.0	74.73	277.2	60.53	246.4	47.83	215.6	36.62	184.8	26.90	154.0	18.68	123.2	11.96	92.4	6.73	
23 °C	308.0	308.0	71.22	277.2	57.69	246.4	45.58	215.6	34.90	184.8	25.64	154.0	17.80	123.2	11.39	92.4	6.41	
21 °C	308.0	308.0	69.55	277.2	56.33	246.4	44.51	215.6	34.08	184.8	25.04	154.0	17.39	123.2	11.13	92.4	6.26	
20 °C	308.0	308.0	68.80	277.2	55.73	246.4	44.03	215.6	33.71	184.8	24.77	154.0	17.20	123.2	11.01	92.4	6.19	
19 °C	308.0	308.0	68.11	277.2	55.17	246.4	43.59	215.6	33.37	184.8	24.52	154.0	17.03	123.2	10.90	92.4	6.13	
17 °C	308.0	308.0	66.88	277.2	54.17	246.4	42.80	215.6	32.77	184.8	24.08	154.0	16.72	123.2	10.70	92.4	6.02	
15 °C	308.0	308.0	65.82	277.2	53.32	246.4	42.13	215.6	32.25	184.8	23.70	154.0	16.46	123.2	10.53	92.4	5.92	

TC : Total Capacity PI : Power Input
Indoor air temperature conditions : 27.0°C dry-bulb / 19.0°C wet bulb

Outdoor Unit Dry-Bulb/Wet-Bulb (°C) (°C)		Outdoor Unit 100% Heating Capacity (kW)	Compressor + Outdoor Fan Power consumption (kW)															
			100% Capacity		90% Capacity		80% Capacity		70% Capacity		60% Capacity		50% Capacity		40% Capacity		30% Capacity	
			TC (kW)	PI (kW)	TC (kW)	PI (kW)	TC (kW)	PI (kW)	TC (kW)	PI (kW)	TC (kW)	PI (kW)	TC (kW)	PI (kW)	TC (kW)	PI (kW)	TC (kW)	PI (kW)
15.0	13.7	325.0	325.0	84.59	292.5	74.93	260.0	65.53	227.5	56.41	195.0	47.55	162.5	38.95	130.0	30.63	97.5	22.57
13.0	11.8	325.0	325.0	86.97	292.5	77.01	260.0	67.33	227.5	57.93	195.0	48.81	162.5	39.97	130.0	31.41	97.5	23.14
11.0	9.8	325.0	325.0	89.63	292.5	79.33	260.0	69.33	227.5	59.63	195.0	50.22	162.5	41.11	130.0	32.29	97.5	23.77
9.0	7.9	325.0	325.0	92.33	292.5	81.69	260.0	71.36	227.5	61.35	195.0	51.64	162.5	42.25	130.0	33.18	97.5	24.41
7.0	6.0	325.0	325.0	95.21	292.5	84.20	260.0	73.53	227.5	63.18	195.0	53.16	162.5	43.48	130.0	34.12	97.5	25.09
5.0	4.1	315.5	315.5	94.92	284.0	83.95	252.4	73.30	220.9	62.99	189.3	53.00	157.8	43.34	126.2	34.02	94.7	25.02
3.0	2.2	306.0	306.0	94.63	275.4	83.69	244.8	73.08	214.2	62.79	183.6	52.84	153.0	43.21	122.4	33.91	91.8	24.94
0.0	-0.7	291.5	291.5	94.19	262.4	83.30	233.2	72.74	204.1	62.50	174.9	52.59	145.8	43.01	116.6	33.75	87.5	24.83
-3.0	-3.7	276.5	276.5	93.73	248.9	82.90	221.2	72.38	193.6	62.20	165.9	52.34	138.3	42.80	110.6	33.59	83.0	24.70
-5.0	-5.6	267.0	267.0	93.44	240.3	82.64	213.6	72.16	186.9	62.01	160.2	52.18	133.5	42.67	106.8	33.49	80.1	24.63
-7.0	-7.6	257.0	257.0	93.14	231.3	82.37	205.6	71.93	179.9	61.80	154.2	52.01	128.5	42.53	102.8	33.38	77.1	24.55
-10	-10.5	242.5	242.5	92.70	218.3	81.98	194.0	71.58	169.8	61.51	145.5	51.76	121.3	42.33	97.0	33.22	72.8	24.43
-14.5	-15.0	220.0	220.0	92.01	198.0	81.37	176.0	71.06	154.0	61.06	132.0	51.38	110.0	42.02	88.0	32.97	66.0	24.25
-19.5	-20.0	195.0	195.0	91.25	175.5	80.70	156.0	70.47	136.5	60.55	117.0	50.95	97.5	41.67	78.0	32.70	58.5	24.05

TC : Total Capacity PI : Power Input
Indoor air temperature conditions : 20.0°C dry-bulb

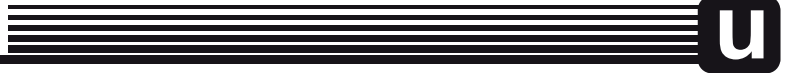

MMY-UP11211HT8P-E (112HP, 313.0 kW system)

Cooling			Compressor + Outdoor Fan Power consumption (kW)															
			100% Capacity		90% Capacity		80% Capacity		70% Capacity		60% Capacity		50% Capacity		40% Capacity		30% Capacity	
			TC	PI	TC	PI	TC	PI	TC	PI	TC	PI	TC	PI	TC	PI	TC	PI
Outdoor Unit Dry-Bulb (°C)	Outdoor Unit 100% Cooling Capacity (kW)	(kW)	(kW)	(kW)	(kW)	(kW)	(kW)	(kW)	(kW)	(kW)	(kW)	(kW)	(kW)	(kW)	(kW)	(kW)	(kW)	
46 °C	245.2	245.2	111.64	220.6	90.45	196.1	71.48	171.6	54.75	147.1	40.25	122.58	27.98	98.1	17.94	73.5	10.13	
43 °C	268.9	268.9	113.72	242.0	92.13	215.1	72.81	188.2	55.77	161.3	40.99	134.4	28.50	107.6	18.27	80.7	10.31	
41 °C	286.4	286.4	116.58	257.8	94.45	229.1	74.64	200.5	57.17	171.8	42.02	143.2	29.21	114.6	18.72	85.9	10.57	
39 °C	296.0	296.0	113.19	266.4	91.70	236.8	72.47	207.2	55.51	177.6	40.80	148.0	28.36	118.4	18.18	88.8	10.26	
37 °C	304.8	304.8	109.76	274.3	88.92	243.8	70.28	213.4	53.83	182.9	39.57	152.4	27.50	121.9	17.63	91.4	9.95	
35 °C	313.0	313.0	108.59	281.7	86.14	250.4	68.08	219.1	52.14	187.8	38.33	156.5	26.64	125.2	17.08	93.9	9.64	
32 °C	313.0	313.0	98.06	281.7	79.44	250.4	62.79	219.1	48.09	187.8	35.35	156.5	24.57	125.2	15.75	93.9	8.89	
31 °C	313.0	313.0	90.74	281.7	73.51	250.4	58.10	219.1	44.50	187.8	32.71	156.5	22.74	125.2	14.58	93.9	8.23	
30 °C	313.0	313.0	87.37	281.7	70.79	250.4	55.94	219.1	42.85	187.8	31.50	156.5	21.90	125.2	14.04	93.9	7.93	
29 °C	313.0	313.0	84.19	281.7	68.20	250.4	53.90	219.1	41.29	187.8	30.35	156.5	21.10	125.2	13.53	93.9	7.64	
27 °C	313.0	313.0	78.28	281.7	63.42	250.4	50.12	219.1	38.39	187.8	28.22	156.5	19.62	125.2	12.58	93.9	7.11	
25 °C	313.0	313.0	72.91	281.7	59.07	250.4	46.69	219.1	35.76	187.8	26.29	156.5	18.28	125.2	11.72	93.9	6.62	
23 °C	313.0	313.0	69.49	281.7	56.30	250.4	44.50	219.1	34.08	187.8	25.06	156.5	17.42	125.2	11.17	93.9	6.31	
21 °C	313.0	313.0	67.86	281.7	54.98	250.4	43.45	219.1	33.28	187.8	24.47	156.5	17.01	125.2	10.91	93.9	6.16	
20 °C	313.0	313.0	67.13	281.7	54.39	250.4	42.99	219.1	32.93	187.8	24.21	156.5	16.83	125.2	10.79	93.9	6.10	
19 °C	313.0	313.0	66.46	281.7	53.84	250.4	42.56	219.1	32.60	187.8	23.97	156.5	16.66	125.2	10.69	93.9	6.04	
17 °C	313.0	313.0	65.26	281.7	52.87	250.4	41.79	219.1	32.01	187.8	23.53	156.5	16.36	125.2	10.49	93.9	5.93	
15 °C	313.0	313.0	64.23	281.7	52.04	250.4	41.13	219.1	31.50	187.8	23.16	156.5	16.10	125.2	10.33	93.9	5.84	

TC : Total Capacity PI : Power Input
Indoor air temperature conditions : 27.0°C dry-bulb / 19.0°C wet bulb

Heating			Compressor + Outdoor Fan Power consumption (kW)															
			100% Capacity		90% Capacity		80% Capacity		70% Capacity		60% Capacity		50% Capacity		40% Capacity		30% Capacity	
			TC	PI	TC	PI	TC	PI	TC	PI	TC	PI	TC	PI	TC	PI	TC	PI
Outdoor Unit Dry-Bulb (°C)	Outdoor Unit Wet-Bulb (°C)	Outdoor Unit 100% Heating Capacity (kW)	(kW)	(kW)	(kW)	(kW)	(kW)	(kW)	(kW)	(kW)	(kW)	(kW)	(kW)	(kW)	(kW)	(kW)	(kW)	(kW)
15.0	13.7	336.0	336.0	86.35	302.4	76.13	268.8	66.29	235.2	56.80	201.6	47.69	168.0	38.93	134.4	30.55	104.4	22.52
13.0	11.8	336.0	336.0	88.88	302.4	78.33	268.8	68.16	235.2	58.38	201.6	48.98	168.0	39.97	134.4	31.33	104.4	23.09
11.0	9.8	336.0	336.0	91.73	302.4	80.80	268.8	70.27	235.2	60.15	201.6	50.43	168.0	41.12	134.4	32.22	104.4	23.71
9.0	7.9	336.0	336.0	94.62	302.4	83.30	268.8	72.41	235.2	61.94	201.6	51.90	168.0	42.29	134.4	33.11	104.4	24.35
7.0	6.0	336.0	336.0	97.71	302.4	85.97	268.8	74.69	235.2	63.86	201.6	53.47	168.0	43.54	134.4	34.06	104.4	25.02
5.0	4.1	326.2	326.2	97.41	293.6	85.71	260.9	74.46	228.3	63.66	195.7	53.31	163.1	43.41	130.47	33.95	97.85	24.95
3.0	2.2	316.4	316.4	97.12	284.7	85.45	253.1	74.24	221.5	63.47	189.8	53.15	158.2	43.27	126.54	33.85	94.91	24.87
0.0	-0.7	301.4	301.4	96.66	271.2	85.05	241.1	73.89	211.0	63.17	180.8	52.90	150.7	43.07	120.55	33.69	90.41	24.76
-3.0	-3.7	285.9	285.9	96.19	257.3	84.64	228.7	73.53	200.1	62.86	171.5	52.64	142.9	42.86	114.34	33.53	85.76	24.64
-5.0	-5.6	276.0	276.0	95.90	248.4	84.38	220.8	73.30	193.2	62.67	165.6	52.48	138.0	42.73	110.42	33.42	82.81	24.56
-7.0	-7.6	265.7	265.7	95.59	239.1	84.10	212.6	73.07	186.0	62.47	159.4	52.31	132.85	42.59	106.28	33.32	79.71	24.48
-10	-10.5	250.7	250.7	95.13	225.6	83.71	200.6	72.72	175.5	62.17	150.4	52.06	125.35	42.39	100.28	33.16	75.21	24.36
-14.5	-15.0	227.4	227.4	94.43	204.7	83.09	182.0	72.18	159.2	61.71	136.5	51.68	113.72	42.08	90.98	32.91	68.23	24.18
-19.5	-20.0	201.6	201.6	93.65	181.4	82.40	161.3	71.58	141.1	61.20	120.96	51.25	100.80	41.73	80.64	32.64	60.48	23.98

TC : Total Capacity PI : Power Input
Indoor air temperature conditions : 20.0°C dry-bulb

MMY-UP11411HT8P-E (114HP, 318.5 kW system)

Outdoor Unit Dry-Bulb (°C)		Outdoor Unit 100% Cooling Capacity (kW)	Compressor + Outdoor Fan Power consumption (kW)															
			100% Capacity		90% Capacity		80% Capacity		70% Capacity		60% Capacity		50% Capacity		40% Capacity		30% Capacity	
			TC (kW)	PI (kW)	TC (kW)	PI (kW)	TC (kW)	PI (kW)	TC (kW)	PI (kW)	TC (kW)	PI (kW)	TC (kW)	PI (kW)	TC (kW)	PI (kW)	TC (kW)	PI (kW)
46 °C		249.5	249.5	114.14	224.5	92.48	199.6	73.11	174.6	56.01	149.7	41.20	124.7	28.66	99.8	18.40	74.8	10.42
43 °C		273.6	273.6	116.25	246.3	94.20	218.9	74.46	191.5	57.05	164.2	41.95	136.8	29.18	109.4	18.74	82.1	10.61
41 °C		291.4	291.4	119.18	262.3	96.56	233.2	76.33	204.0	58.48	174.9	43.00	145.7	29.91	116.6	19.20	87.4	10.87
39 °C		301.2	301.2	115.71	271.0	93.76	240.9	74.11	210.8	56.78	180.7	41.75	150.6	29.04	120.5	18.64	90.3	10.55
37 °C		310.1	310.1	112.21	279.1	90.92	248.1	71.87	217.1	55.06	186.1	40.49	155.1	28.16	124.1	18.08	93.0	10.23
35 °C		318.5	318.5	111.01	286.7	88.07	254.8	69.62	223.0	53.34	191.1	39.22	159.3	27.28	127.4	17.51	95.6	9.91
32 °C		318.5	318.5	100.25	286.7	81.23	254.8	64.21	223.0	49.19	191.1	36.18	159.3	25.17	127.4	16.16	95.6	9.15
31 °C		318.5	318.5	92.76	286.7	75.16	254.8	59.42	223.0	45.52	191.1	33.48	159.3	23.29	127.4	14.95	95.6	8.47
30 °C		318.5	318.5	89.32	286.7	72.38	254.8	57.21	223.0	43.84	191.1	32.24	159.3	22.43	127.4	14.40	95.6	8.16
29 °C		318.5	318.5	86.07	286.7	69.74	254.8	55.13	223.0	42.24	191.1	31.07	159.3	21.61	127.4	13.88	95.6	7.86
27 °C		318.5	318.5	80.03	286.7	64.85	254.8	51.27	223.0	39.28	191.1	28.89	159.3	20.10	127.4	12.91	95.6	7.32
25 °C		318.5	318.5	74.54	286.7	60.40	254.8	47.75	223.0	36.59	191.1	26.91	159.3	18.72	127.4	12.03	95.6	6.82
23 °C		318.5	318.5	71.05	286.7	57.57	254.8	45.51	223.0	34.87	191.1	25.65	159.3	17.85	127.4	11.46	95.6	6.50
21 °C		318.5	318.5	69.38	286.7	56.22	254.8	44.45	223.0	34.06	191.1	25.05	159.3	17.43	127.4	11.20	95.6	6.35
20 °C		318.5	318.5	68.64	286.7	55.62	254.8	43.97	223.0	33.69	191.1	24.78	159.3	17.25	127.4	11.08	95.6	6.28
19 °C		318.5	318.5	67.95	286.7	55.06	254.8	43.53	223.0	33.35	191.1	24.54	159.3	17.07	127.4	10.97	95.6	6.22
17 °C		318.5	318.5	66.72	286.7	54.07	254.8	42.74	223.0	32.75	191.1	24.09	159.3	16.77	127.4	10.77	95.6	6.11
15 °C		318.5	318.5	65.67	286.7	53.22	254.8	42.07	223.0	32.24	191.1	23.72	159.3	16.51	127.4	10.60	95.6	6.02

TC : Total Capacity PI : Power Input
Indoor air temperature conditions : 27.0°C dry-bulb / 19.0°C wet bulb

Outdoor Unit Dry-Bulb/Wet-Bulb (°C) (°C)		Outdoor Unit 100% Heating Capacity (kW)	Compressor + Outdoor Fan Power consumption (kW)															
			100% Capacity		90% Capacity		80% Capacity		70% Capacity		60% Capacity		50% Capacity		40% Capacity		30% Capacity	
			TC (kW)	PI (kW)	TC (kW)	PI (kW)	TC (kW)	PI (kW)	TC (kW)	PI (kW)	TC (kW)	PI (kW)	TC (kW)	PI (kW)	TC (kW)	PI (kW)	TC (kW)	PI (kW)
15.0	13.7	342.0	342.0	87.66	307.8	77.40	273.6	67.49	239.4	57.91	205.2	48.67	171.0	39.77	136.8	31.20	102.6	22.98
13.0	11.8	342.0	342.0	90.19	307.8	79.61	273.6	69.38	239.4	59.51	205.2	49.99	171.0	40.82	136.8	32.01	102.6	23.56
11.0	9.8	342.0	342.0	93.04	307.8	82.08	273.6	71.50	239.4	61.29	205.2	51.46	171.0	42.00	136.8	32.91	102.6	24.20
9.0	7.9	342.0	342.0	95.93	307.8	84.59	273.6	73.65	239.4	63.10	205.2	52.95	171.0	43.19	136.8	33.82	102.6	24.85
7.0	6.0	342.0	342.0	99.02	307.8	87.27	273.6	75.94	239.4	65.03	205.2	54.53	171.0	44.45	136.8	34.79	102.6	25.55
5.0	4.1	332.0	332.0	98.72	298.8	87.01	265.6	75.71	232.4	64.83	199.2	54.37	166.0	44.32	132.8	34.69	99.6	25.47
3.0	2.2	322.0	322.0	98.42	289.8	86.74	257.6	75.48	225.4	64.63	193.2	54.20	161.0	44.18	128.8	34.58	96.6	25.39
0.0	-0.7	306.8	306.8	97.96	276.1	86.34	245.4	75.13	214.7	64.33	184.1	53.95	153.4	43.98	122.7	34.42	92.0	25.27
-3.0	-3.7	291.0	291.0	97.48	261.9	85.92	232.8	74.76	203.7	64.02	174.6	53.69	145.5	43.76	116.4	34.25	87.3	25.15
-5.0	-5.6	281.0	281.0	97.18	252.9	85.65	224.8	74.53	196.7	63.82	168.6	53.52	140.5	43.63	112.4	34.15	84.3	25.07
-7.0	-7.6	270.4	270.4	96.87	243.4	85.37	216.4	74.29	189.3	63.61	162.3	53.35	135.2	43.49	108.2	34.03	81.1	24.99
-10	-10.5	255.2	255.2	96.41	229.7	84.97	204.1	73.94	178.6	63.31	153.1	53.09	127.6	43.28	102.1	33.87	76.6	24.87
-14.5	-15.0	231.5	231.5	95.69	208.4	84.34	185.2	73.39	162.1	62.84	138.9	52.70	115.8	42.96	92.6	33.62	69.5	24.69
-19.5	-20.0	205.2	205.2	94.90	184.7	83.64	164.2	72.78	143.6	62.32	123.1	52.26	102.6	42.60	82.1	33.34	61.6	24.48

TC : Total Capacity PI : Power Input
Indoor air temperature conditions : 20.0°C dry-bulb

MMY-UP11611HT8P-E (116HP, 324.0 kW system)

Cooling

Outdoor Unit Dry-Bulb (°C)		Outdoor Unit 100% Cooling Capacity (kW)	Compressor + Outdoor Fan Power consumption (kW)															
			100% Capacity		90% Capacity		80% Capacity		70% Capacity		60% Capacity		50% Capacity		40% Capacity		30% Capacity	
			TC (kW)	PI (kW)	TC (kW)	PI (kW)	TC (kW)	PI (kW)	TC (kW)	PI (kW)	TC (kW)	PI (kW)	TC (kW)	PI (kW)	TC (kW)	PI (kW)	TC (kW)	PI (kW)
46 °C	253.8	253.8	117.99	228.4	95.58	203.0	75.53	177.6	57.84	152.3	42.51	126.9	29.53	101.5	18.92	76.1	10.66	
43 °C	278.3	278.3	120.19	250.5	97.36	222.7	76.94	194.8	58.92	167.0	43.30	139.2	30.08	111.3	19.27	83.5	10.86	
41 °C	296.5	296.5	123.22	266.8	99.81	237.2	78.87	207.5	60.40	177.9	44.39	148.2	30.84	118.6	19.75	88.9	11.13	
39 °C	306.4	306.4	119.64	275.7	96.91	245.1	76.58	214.4	58.64	183.8	43.10	153.2	29.94	122.5	19.18	91.9	10.80	
37 °C	315.5	315.5	116.01	283.9	93.98	252.4	74.26	220.8	56.87	189.3	41.79	157.7	29.03	126.2	18.60	94.6	10.48	
35 °C	324.0	324.0	114.77	291.6	91.04	259.2	71.94	226.8	55.09	194.4	40.48	162.0	28.13	129.6	18.01	97.2	10.15	
32 °C	324.0	324.0	103.64	291.6	83.96	259.2	66.34	226.8	50.80	194.4	37.34	162.0	25.94	129.6	16.61	97.2	9.36	
31 °C	324.0	324.0	95.90	291.6	77.68	259.2	61.39	226.8	47.01	194.4	34.55	162.0	24.00	129.6	15.37	97.2	8.66	
30 °C	324.0	324.0	92.34	291.6	74.80	259.2	59.11	226.8	45.27	194.4	33.27	162.0	23.11	129.6	14.80	97.2	8.34	
29 °C	324.0	324.0	88.97	291.6	72.08	259.2	56.96	226.8	43.62	194.4	32.05	162.0	22.27	129.6	14.27	97.2	8.04	
27 °C	324.0	324.0	82.73	291.6	67.02	259.2	52.96	226.8	40.56	194.4	29.81	162.0	20.71	129.6	13.27	97.2	7.48	
25 °C	324.0	324.0	77.06	291.6	62.42	259.2	49.33	226.8	37.77	194.4	27.76	162.0	19.29	129.6	12.36	97.2	6.96	
23 °C	324.0	324.0	73.44	291.6	59.49	259.2	47.01	226.8	36.00	194.4	26.46	162.0	18.38	129.6	11.78	97.2	6.64	
21 °C	324.0	324.0	71.72	291.6	58.10	259.2	45.91	226.8	35.16	194.4	25.84	162.0	17.95	129.6	11.50	97.2	6.48	
20 °C	324.0	324.0	70.95	291.6	57.47	259.2	45.42	226.8	34.78	194.4	25.56	162.0	17.76	129.6	11.38	97.2	6.41	
19 °C	324.0	324.0	70.23	291.6	56.90	259.2	44.96	226.8	34.43	194.4	25.30	162.0	17.58	129.6	11.26	97.2	6.35	
17 °C	324.0	324.0	68.96	291.6	55.87	259.2	44.15	226.8	33.81	194.4	24.85	162.0	17.26	129.6	11.06	97.2	6.24	
15 °C	324.0	324.0	67.88	291.6	54.99	259.2	43.45	226.8	33.28	194.4	24.46	162.0	16.99	129.6	10.89	97.2	6.14	

TC : Total Capacity PI : Power Input
Indoor air temperature conditions : 27.0°C dry-bulb / 19.0°C wet bulb

Heating

Outdoor Unit Dry-Bulb/Wet-Bulb (°C) (°C)		Outdoor Unit 100% Heating Capacity (kW)	Compressor + Outdoor Fan Power consumption (kW)															
			100% Capacity		90% Capacity		80% Capacity		70% Capacity		60% Capacity		50% Capacity		40% Capacity		30% Capacity	
			TC (kW)	PI (kW)	TC (kW)	PI (kW)	TC (kW)	PI (kW)	TC (kW)	PI (kW)	TC (kW)	PI (kW)	TC (kW)	PI (kW)	TC (kW)	PI (kW)	TC (kW)	PI (kW)
15.0	13.7	343.0	343.0	89.48	308.7	79.21	274.4	69.25	240.1	59.58	205.8	50.22	171.5	41.15	137.2	32.39	102.9	23.92
13.0	11.8	343.0	343.0	92.00	308.7	81.42	274.4	71.15	240.1	61.19	205.8	51.55	171.5	42.23	137.2	33.22	102.9	24.52
11.0	9.8	343.0	343.0	94.84	308.7	83.89	274.4	73.28	240.1	62.99	205.8	53.04	171.5	43.42	137.2	34.14	102.9	25.18
9.0	7.9	343.0	343.0	97.71	308.7	86.40	274.4	75.43	240.1	64.81	205.8	54.55	171.5	44.63	137.2	35.07	102.9	25.86
7.0	6.0	343.0	343.0	100.78	308.7	89.07	274.4	77.73	240.1	66.75	205.8	56.15	171.5	45.92	137.2	36.06	102.9	26.57
5.0	4.1	333.0	333.0	100.47	299.7	88.80	266.4	77.49	233.1	66.55	199.8	55.98	166.5	45.78	133.2	35.95	99.9	26.49
3.0	2.2	323.0	323.0	100.17	290.7	88.53	258.4	77.25	226.1	66.35	193.8	55.81	161.5	45.64	129.2	35.84	96.9	26.41
0.0	-0.7	307.6	307.6	99.70	276.9	88.11	246.1	76.89	215.4	66.04	184.6	55.55	153.8	45.43	123.1	35.67	92.3	26.28
-3.0	-3.7	291.8	291.8	99.22	262.6	87.69	233.5	76.52	204.3	65.72	175.1	55.28	145.9	45.21	116.7	35.50	87.5	26.16
-5.0	-5.6	281.8	281.8	98.91	253.6	87.42	225.4	76.28	197.3	65.52	169.1	55.11	140.9	45.07	112.7	35.39	84.5	26.08
-7.0	-7.6	271.2	271.2	98.59	244.1	87.13	217.0	76.04	189.9	65.30	162.7	54.93	135.6	44.92	108.5	35.28	81.4	25.99
-10	-10.5	255.9	255.9	98.12	230.3	86.72	204.7	75.68	179.2	64.99	153.6	54.67	128.0	44.71	102.4	35.11	76.8	25.87
-14.5	-15.0	232.2	232.2	97.39	209.0	86.08	185.7	75.12	162.5	64.51	139.3	54.27	116.1	44.38	92.9	34.85	69.7	25.68
-19.5	-20.0	205.8	205.8	96.59	185.2	85.36	164.6	74.49	144.1	63.98	123.5	53.82	102.9	44.01	82.3	34.56	61.7	25.46

TC : Total Capacity PI : Power Input
Indoor air temperature conditions : 20.0°C dry-bulb

MMY-UP11811HT8P-E (118HP, 329.5 kW system)

Cooling		Compressor + Outdoor Fan Power consumption (kW)																	
		Outdoor Unit		100% Capacity		90% Capacity		80% Capacity		70% Capacity		60% Capacity		50% Capacity		40% Capacity		30% Capacity	
		Dry-Bulb (°C)	100% Cooling Capacity (kW)	TC	PI	TC	PI	TC	PI	TC	PI	TC	PI	TC	PI	TC	PI	TC	PI
46 °C	258.1	258.1	120.49	232.3	97.62	206.5	77.16	180.7	59.10	154.8	43.45	129.0	30.21	103.2	19.38	77.4	10.95		
43 °C	283.1	283.1	122.73	254.8	99.43	226.4	78.59	198.1	60.20	169.8	44.26	141.5	30.77	113.2	19.73	84.9	11.15		
41 °C	301.5	301.5	125.81	271.4	101.93	241.2	80.56	211.1	61.71	180.9	45.37	150.8	31.54	120.6	20.23	90.5	11.43		
39 °C	311.6	311.6	122.16	280.4	98.97	249.2	78.22	218.1	59.91	186.9	44.05	155.8	30.62	124.6	19.64	93.5	11.09		
37 °C	320.9	320.9	118.46	288.8	95.97	256.7	75.85	224.6	58.10	192.5	42.71	160.4	29.69	128.3	19.04	96.3	10.76		
35 °C	329.5	329.5	117.19	296.6	92.97	263.6	73.48	230.7	56.28	197.7	41.38	164.8	28.77	131.8	18.45	98.9	10.42		
32 °C	329.5	329.5	105.83	296.6	85.74	263.6	67.77	230.7	51.91	197.7	38.16	164.8	26.53	131.8	17.02	98.9	9.62		
31 °C	329.5	329.5	97.92	296.6	79.34	263.6	62.71	230.7	48.03	197.7	35.31	164.8	24.55	131.8	15.75	98.9	8.90		
30 °C	329.5	329.5	94.29	296.6	76.40	263.6	60.38	230.7	46.25	197.7	34.01	164.8	23.64	131.8	15.17	98.9	8.57		
29 °C	329.5	329.5	90.86	296.6	73.61	263.6	58.18	230.7	44.57	197.7	32.77	164.8	22.78	131.8	14.62	98.9	8.26		
27 °C	329.5	329.5	84.48	296.6	68.45	263.6	54.10	230.7	41.44	197.7	30.47	164.8	21.19	131.8	13.59	98.9	7.69		
25 °C	329.5	329.5	78.69	296.6	63.75	263.6	50.39	230.7	38.60	197.7	28.38	164.8	19.74	131.8	12.66	98.9	7.16		
23 °C	329.5	329.5	75.00	296.6	60.76	263.6	48.03	230.7	36.79	197.7	27.05	164.8	18.81	131.8	12.07	98.9	6.83		
21 °C	329.5	329.5	73.24	296.6	59.34	263.6	46.90	230.7	35.93	197.7	26.42	164.8	18.37	131.8	11.79	98.9	6.67		
20 °C	329.5	329.5	72.45	296.6	58.70	263.6	46.40	230.7	35.55	197.7	26.14	164.8	18.18	131.8	11.66	98.9	6.60		
19 °C	329.5	329.5	71.73	296.6	58.11	263.6	45.94	230.7	35.19	197.7	25.88	164.8	17.99	131.8	11.55	98.9	6.53		
17 °C	329.5	329.5	70.43	296.6	57.06	263.6	45.10	230.7	34.55	197.7	25.41	164.8	17.67	131.8	11.34	98.9	6.42		
15 °C	329.5	329.5	69.32	296.6	56.17	263.6	44.40	230.7	34.01	197.7	25.01	164.8	17.39	131.8	11.16	98.9	6.32		

TC : Total Capacity PI : Power Input
 Indoor air temperature conditions : 27.0°C dry-bulb / 19.0°C wet bulb

Heating			Compressor + Outdoor Fan Power consumption (kW)																	
			Outdoor Unit		100% Capacity		90% Capacity		80% Capacity		70% Capacity		60% Capacity		50% Capacity		40% Capacity		30% Capacity	
			Dry-Bulb (°C)	Wet-Bulb (°C)	Heating Capacity (kW)	TC	PI	TC	PI	TC	PI	TC	PI	TC	PI	TC	PI	TC	PI	
15.0	13.7	349.0	349.0	90.79	314.1	80.48	279.2	70.45	244.3	60.69	209.4	51.20	174.5	41.99	139.6	33.05	104.7	24.38		
13.0	11.8	349.0	349.0	93.32	314.1	82.70	279.2	72.36	244.3	62.32	209.4	52.55	174.5	43.08	139.6	33.89	104.7	24.99		
11.0	9.8	349.0	349.0	96.15	314.1	85.18	279.2	74.50	244.3	64.13	209.4	54.06	174.5	44.30	139.6	34.83	104.7	25.67		
9.0	7.9	349.0	349.0	99.03	314.1	87.69	279.2	76.67	244.3	65.97	209.4	55.59	174.5	45.53	139.6	35.79	104.7	26.36		
7.0	6.0	349.0	349.0	102.09	314.1	90.37	279.2	78.98	244.3	67.93	209.4	57.21	174.5	46.84	139.6	36.80	104.7	27.09		
5.0	4.1	338.8	338.8	101.78	304.9	90.09	271.0	78.74	237.2	67.72	203.3	57.04	169.4	46.70	135.5	36.68	101.6	27.01		
3.0	2.2	328.6	328.6	101.47	295.7	89.82	262.9	78.50	230.0	67.52	197.2	56.87	164.3	46.55	131.4	36.57	98.6	26.93		
0.0	-0.7	313.0	313.0	101.00	281.7	89.40	250.4	78.13	219.1	67.20	187.8	56.60	156.5	46.34	125.2	36.40	93.9	26.80		
-3.0	-3.7	296.9	296.9	100.51	267.2	88.96	237.5	77.75	207.8	66.87	178.2	56.33	148.5	46.11	118.8	36.23	89.1	26.67		
-5.0	-5.6	286.7	286.7	100.20	258.0	88.69	229.4	77.51	200.7	66.67	172.0	56.15	143.4	45.97	114.7	36.11	86.0	26.59		
-7.0	-7.6	276.0	276.0	99.87	248.4	88.40	220.8	77.26	193.2	66.45	165.6	55.97	138.0	45.82	110.4	36.00	82.8	26.50		
-10	-10.5	260.4	260.4	99.40	234.4	87.98	208.3	76.89	182.3	66.14	156.2	55.70	130.2	45.60	104.2	35.83	78.1	26.38		
-14.5	-15.0	236.2	236.2	98.66	212.6	87.33	189.0	76.33	165.4	65.65	141.7	55.29	118.1	45.26	94.5	35.56	70.9	26.18		
-19.5	-20.0	209.4	209.4	97.84	188.5	86.61	167.5	75.69	146.6	65.10	125.6	54.83	104.7	44.89	83.8	35.27	62.8	25.97		

TC : Total Capacity PI : Power Input
 Indoor air temperature conditions : 20.0°C dry-bulb

MMY-UP12011HT8P-E (120HP, 335.0kW system)

Outdoor Unit Dry-Bulb (°C)		Outdoor Unit 100% Cooling Capacity (kW)	Compressor + Outdoor Fan Power consumption (kW)															
			100% Capacity		90% Capacity		80% Capacity		70% Capacity		60% Capacity		50% Capacity		40% Capacity		30% Capacity	
			TC (kW)	PI (kW)	TC (kW)	PI (kW)	TC (kW)	PI (kW)	TC (kW)	PI (kW)	TC (kW)	PI (kW)	TC (kW)	PI (kW)	TC (kW)	PI (kW)	TC (kW)	PI (kW)
46 °C		262.4	124.34	236.2	100.72	209.9	79.58	183.7	60.93	157.4	44.76	131.2	31.09	105.0	19.89	78.72	11.19	
43 °C		287.8	126.66	259.0	102.60	230.2	81.06	201.5	62.06	172.7	45.60	143.9	31.67	115.1	20.27	86.34	11.40	
41 °C		306.5	129.85	275.9	105.18	245.2	83.11	214.6	63.63	183.9	46.75	153.3	32.46	122.6	20.78	91.96	11.69	
39 °C		316.8	126.08	285.1	102.13	253.4	80.69	221.7	61.78	190.1	45.39	158.4	31.52	126.7	20.17	95.03	11.35	
37 °C		326.2	122.26	293.6	99.03	261.0	78.25	228.3	59.91	195.7	44.01	163.1	30.57	130.5	19.56	97.86	11.00	
35 °C		335.0	120.95	301.5	95.94	268.0	75.80	234.5	58.04	201.0	42.64	167.5	29.61	134.0	18.95	100.5	10.66	
32 °C		335.0	109.22	301.5	88.47	268.0	69.90	234.5	53.52	201.0	39.32	167.5	27.31	134.0	17.48	100.5	9.83	
31 °C		335.0	101.06	301.5	81.86	268.0	64.68	234.5	49.52	201.0	36.38	167.5	25.26	134.0	16.17	100.5	9.10	
30 °C		335.0	97.31	301.5	78.82	268.0	62.28	234.5	47.68	201.0	35.03	167.5	24.33	134.0	15.57	100.5	8.76	
29 °C		335.0	93.76	301.5	75.95	268.0	60.01	234.5	45.94	201.0	33.75	167.5	23.44	134.0	15.00	100.5	8.44	
27 °C		335.0	87.18	301.5	70.62	268.0	55.80	234.5	42.72	201.0	31.39	167.5	21.80	134.0	13.95	100.5	7.85	
25 °C		335.0	81.20	301.5	65.77	268.0	51.97	234.5	39.79	201.0	29.23	167.5	20.30	134.0	12.99	100.5	7.31	
23 °C		335.0	77.39	301.5	62.68	268.0	49.53	234.5	37.92	201.0	27.86	167.5	19.35	134.0	12.38	100.5	6.96	
21 °C		335.0	75.57	301.5	61.21	268.0	48.37	234.5	37.03	201.0	27.21	167.5	18.89	134.0	12.09	100.5	6.80	
20 °C		335.0	74.76	301.5	60.56	268.0	47.85	234.5	36.63	201.0	26.91	167.5	18.69	134.0	11.96	100.5	6.73	
19 °C		335.0	74.01	301.5	59.95	268.0	47.37	234.5	36.26	201.0	26.64	167.5	18.50	134.0	11.84	100.5	6.66	
17 °C		335.0	72.67	301.5	58.86	268.0	46.51	234.5	35.61	201.0	26.16	167.5	18.17	134.0	11.63	100.5	6.54	
15 °C		335.0	71.52	301.5	57.93	268.0	45.78	234.5	35.05	201.0	25.75	167.5	17.88	134.0	11.44	100.5	6.44	

TC : Total Capacity PI : Power Input
Indoor air temperature conditions : 27.0°C dry-bulb / 19.0°C wet bulb

Outdoor Unit Dry-Bulb/Wet-Bulb (°C) (°C)		Outdoor Unit 100% Heating Capacity (kW)	Compressor + Outdoor Fan Power consumption (kW)															
			100% Capacity		90% Capacity		80% Capacity		70% Capacity		60% Capacity		50% Capacity		40% Capacity		30% Capacity	
			TC (kW)	PI (kW)	TC (kW)	PI (kW)	TC (kW)	PI (kW)	TC (kW)	PI (kW)	TC (kW)	PI (kW)	TC (kW)	PI (kW)	TC (kW)	PI (kW)	TC (kW)	PI (kW)
15.0	13.7	350.0	92.61	315.0	82.29	280.0	72.21	245.0	62.36	210.0	52.75	175.0	43.37	140.0	34.23	105.0	25.32	
13.0	11.8	350.0	95.13	315.0	84.51	280.0	74.13	245.0	64.00	210.0	54.12	175.0	44.49	140.0	35.10	105.0	25.95	
11.0	9.8	350.0	97.95	315.0	86.99	280.0	76.28	245.0	65.84	210.0	55.65	175.0	45.73	140.0	36.06	105.0	26.66	
9.0	7.9	350.0	100.81	315.0	89.49	280.0	78.45	245.0	67.69	210.0	57.19	175.0	46.98	140.0	37.03	105.0	27.36	
7.0	6.0	350.0	103.85	315.0	92.16	280.0	80.76	245.0	69.65	210.0	58.84	175.0	48.31	140.0	38.07	105.0	28.11	
5.0	4.1	339.8	103.54	305.8	91.88	271.8	80.52	237.8	69.44	203.9	58.66	169.9	48.16	135.9	37.95	101.9	28.03	
3.0	2.2	329.5	103.22	296.6	91.60	263.6	80.27	230.7	69.23	197.7	58.48	164.8	48.01	131.8	37.83	98.9	27.94	
0.0	-0.7	313.9	102.74	282.5	91.18	251.1	79.90	219.7	68.91	188.4	58.21	157.0	47.79	125.6	37.66	94.2	27.81	
-3.0	-3.7	297.8	102.24	268.0	90.73	238.2	79.51	208.4	68.57	178.7	57.92	148.9	47.56	119.1	37.48	89.3	27.68	
-5.0	-5.6	287.5	101.92	258.8	90.45	230.0	79.27	201.3	68.36	172.5	57.74	143.8	47.41	115.0	37.36	86.3	27.59	
-7.0	-7.6	276.8	101.59	249.1	90.16	221.4	79.01	193.7	68.14	166.1	57.56	138.4	47.26	110.7	37.24	83.0	27.50	
-10	-10.5	261.2	101.11	235.0	89.73	208.9	78.63	182.8	67.82	156.7	57.28	130.6	47.03	104.5	37.06	78.3	27.37	
-14.5	-15.0	236.9	100.36	213.2	89.07	189.5	78.05	165.8	67.32	142.2	56.86	118.5	46.68	94.8	36.79	71.1	27.17	
-19.5	-20.0	210.0	99.53	189.0	88.33	168.0	77.40	147.0	66.76	126.0	56.39	105.0	46.30	84.0	36.48	63.0	26.95	

TC : Total Capacity PI : Power Input
Indoor air temperature conditions : 20.0°C dry-bulb

5-11. Sound data (NC curve)

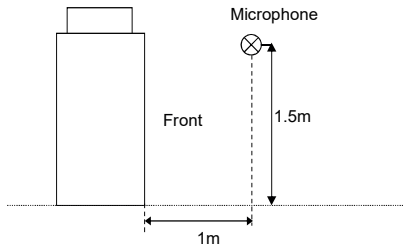

Standard model

MMY-MUP0801HT8P-E

Sound pressure Level (dB(A))	Cooling	Heating
	53.0	56.0

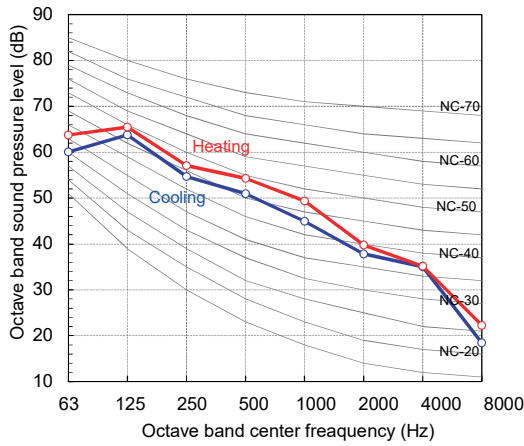

MMY-MUP1001HT8P-E

Sound pressure Level (dB(A))	Cooling	Heating
	55.0	58.0

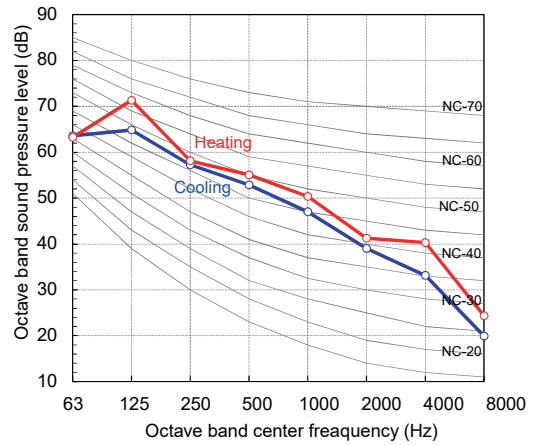

MMY-MUP1201HT8P-E

Sound pressure Level (dB(A))	Cooling	Heating
	58.0	62.0

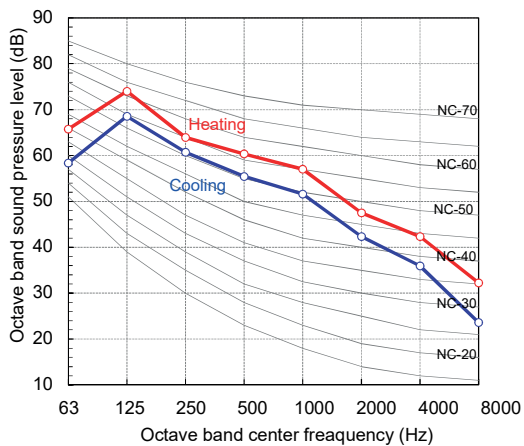

MMY-MUP1401HT8P-E

Sound pressure Level (dB(A))	Cooling	Heating
	58.0	62.0

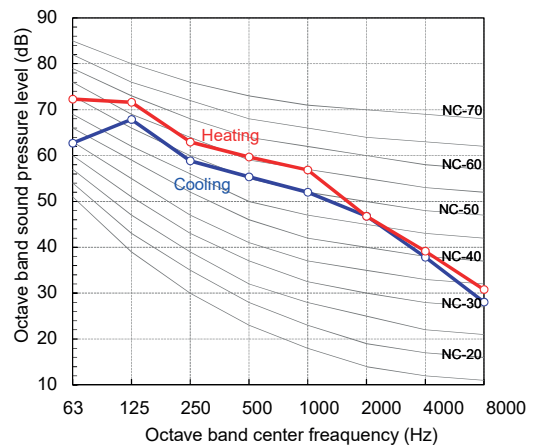

MMY-MUP1601HT8P-E

Sound pressure Level (dB(A))	Cooling	Heating
	60.0	63.0

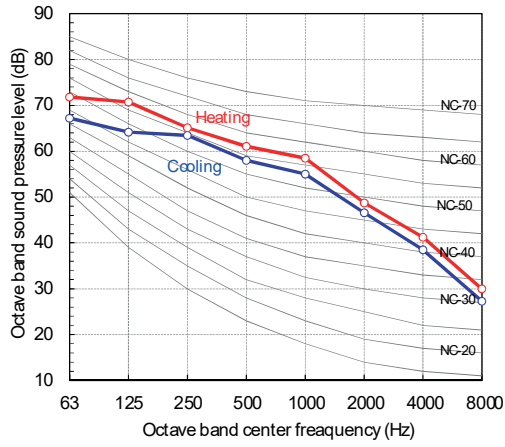

MMY-MUP1801HT8P-E

Sound pressure Level (dB(A))	Cooling	Heating
	61.0	67.0

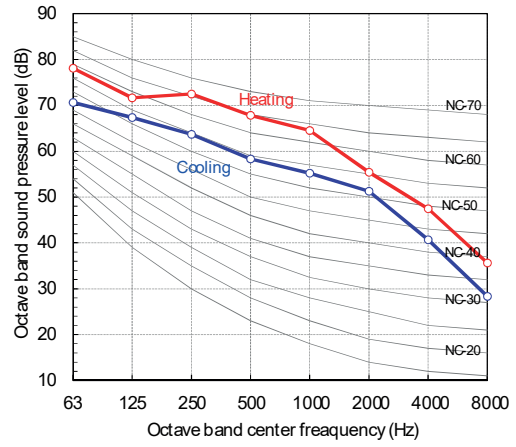

MMY-MUP2001HT8P-E

Sound pressure Level (dB(A))	Cooling	Heating
	63.0	67.0

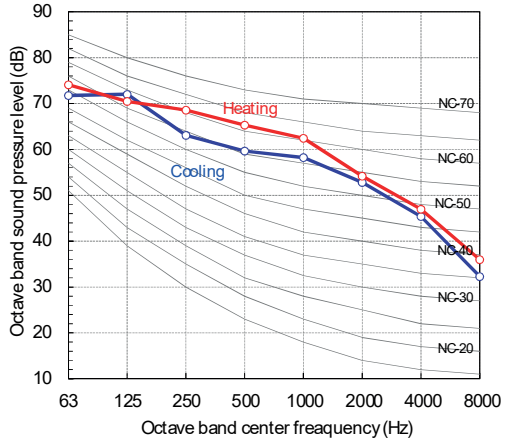

MMY-MUP2201HT8P-E

Sound pressure Level (dB(A))	Cooling	Heating
	63.0	67.0

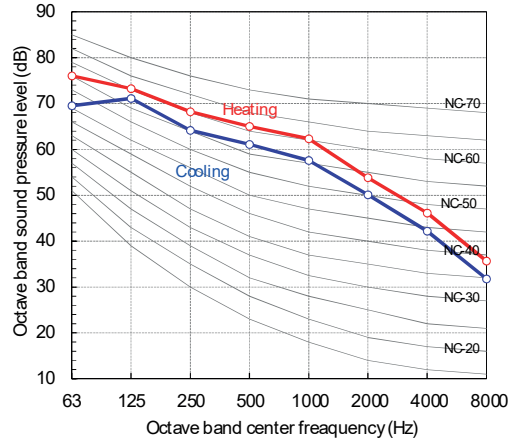

MMY-MUP2401HT8P-E1

Sound pressure Level (dB(A))	Cooling	Heating
	63.0	67.0

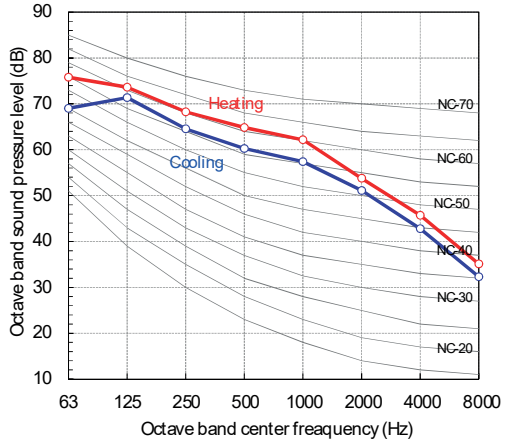

MMY-UP2611HT8P-E

Sound pressure Level (dB(A))	Cooling	Heating
	61.5	65.5

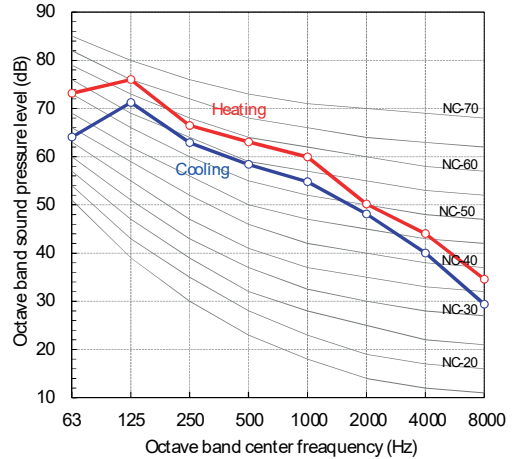

MMY-UP2811HT8P-E

Sound pressure Level (dB(A))	Cooling	Heating
	61.5	65.5

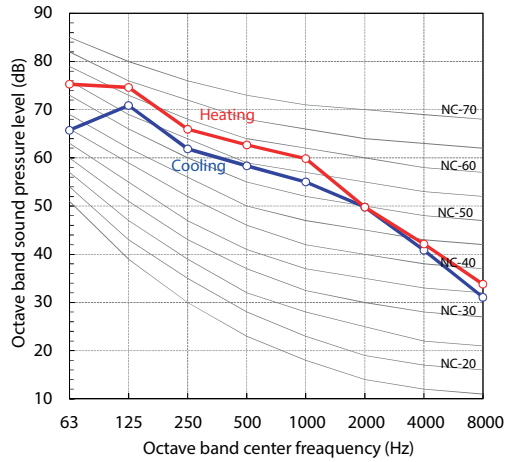

MMY-UP3011HT8P-E

Sound pressure Level (dB(A))	Cooling	Heating
	63.0	68.5

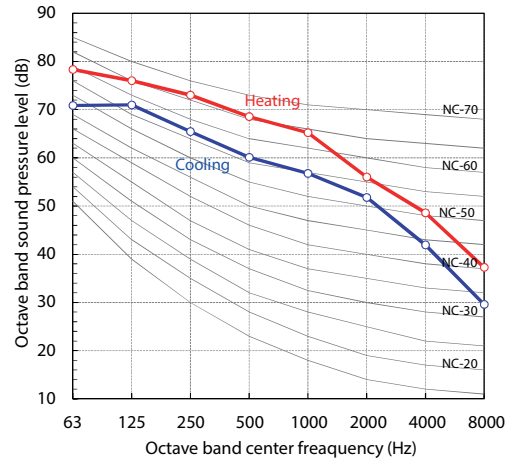

MMY-UP3211HT8P-E

Sound pressure Level (dB(A))	Cooling	Heating
	64.5	68.5

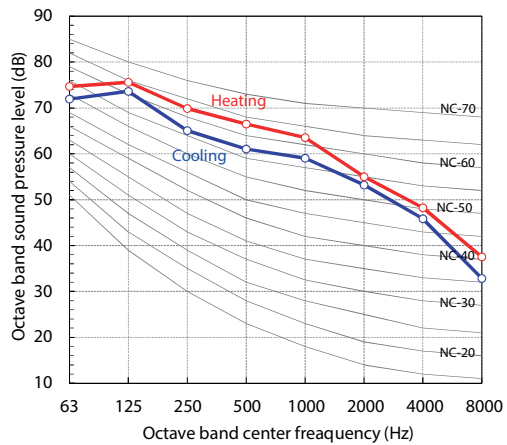

MMY-UP3411HT8P-E

Sound pressure Level (dB(A))	Cooling	Heating
	64.5	68.5

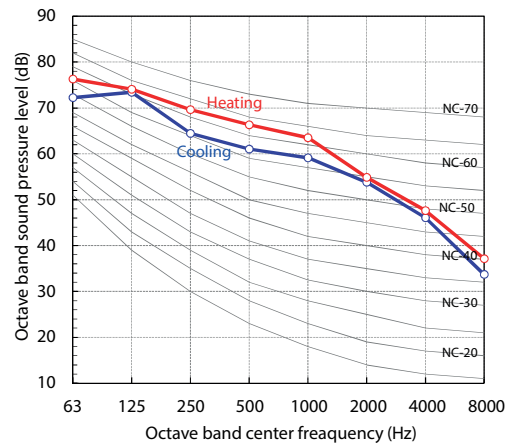

MMY-UP3611HT8P-E

Sound pressure Level (dB(A))	Cooling	Heating
	64.5	68.5

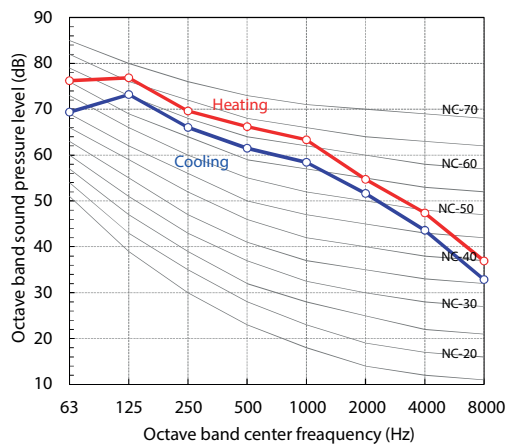

MMY-UP3811HT8P-E

Sound pressure Level (dB(A))	Cooling	Heating
	64.5	68.5

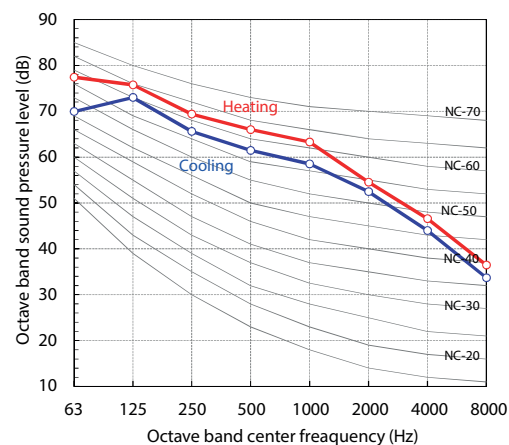

MMY-UP4011HT8P-E

Sound pressure Level (dB (A))	Cooling	Heating
	66.5	70.5

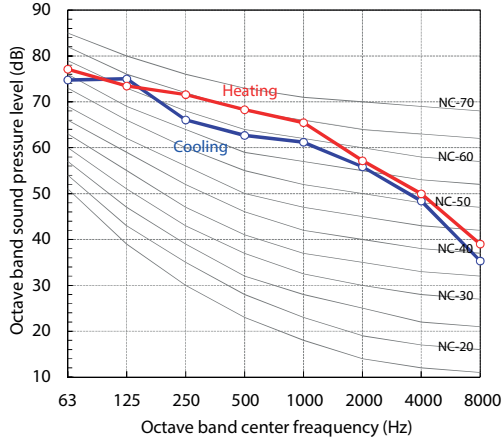

MMY-UP4211HT8P-E

Sound pressure Level (dB (A))	Cooling	Heating
	65.5	70.5

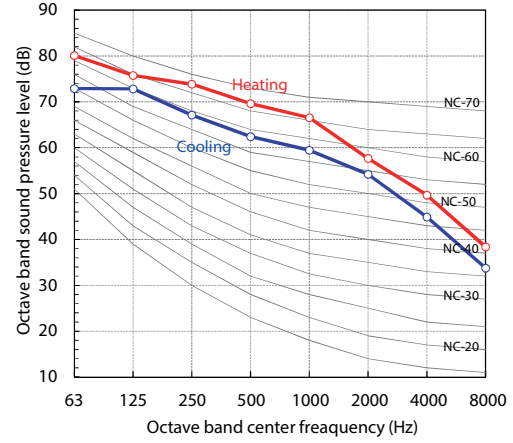

MMY-UP4411HT8P-E

Sound pressure Level (dB (A))	Cooling	Heating
	66.5	70.5

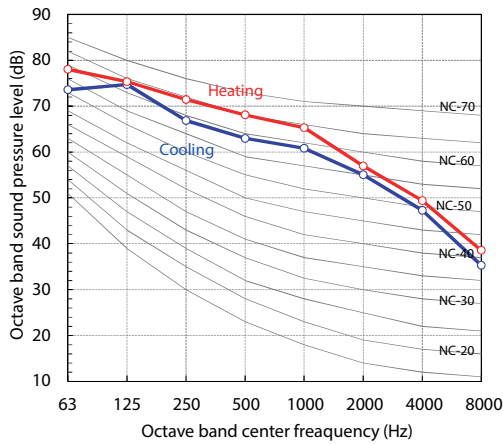

MMY-UP4611HT8P-E

Sound pressure Level (dB (A))	Cooling	Heating
	66.5	70.5

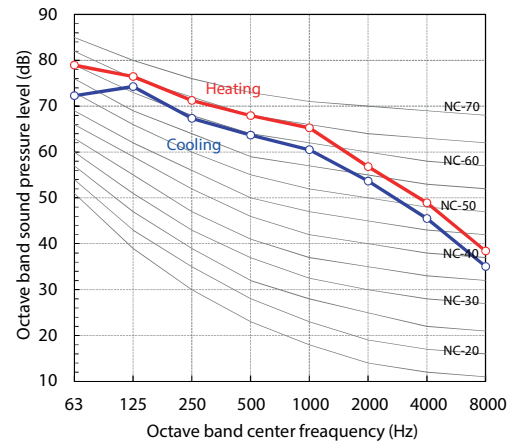

MMY-UP4811HT8P-E

Sound pressure Level (dB (A))	Cooling	Heating
	66.5	70.5

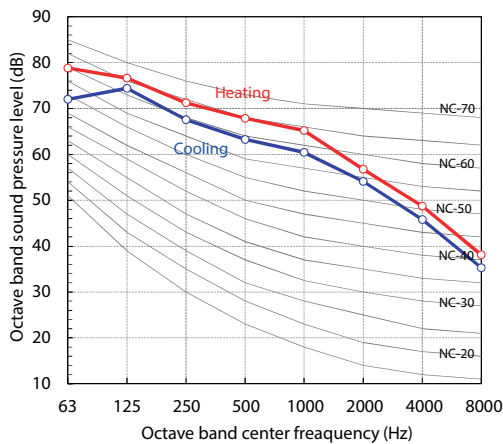

MMY-UP5011HT8P-E

Sound pressure Level (dB (A))	Cooling	Heating
	65.5	69.5

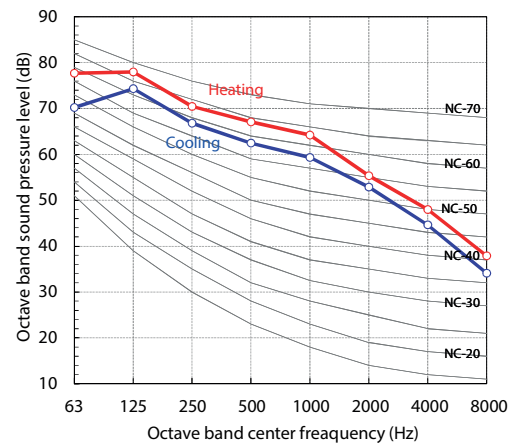

MMY-UP5211HT8P-E

Sound pressure Level (dB(A))	Cooling	Heating
	65.5	69.5

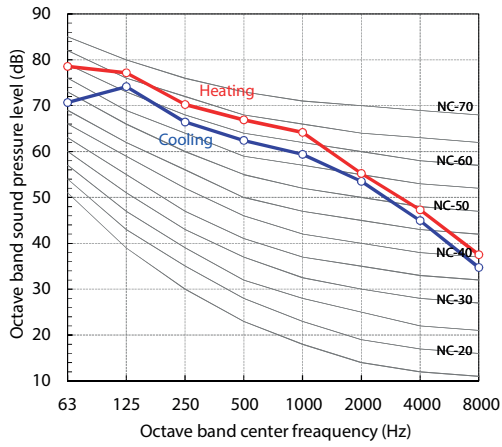

MMY-UP5411HT8P-E

Sound pressure Level (dB(A))	Cooling	Heating
	67.0	71.0

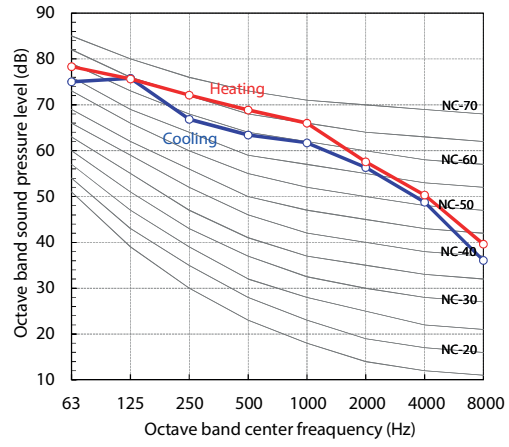

MMY-UP5611HT8P-E

Sound pressure Level (dB(A))	Cooling	Heating
	67.0	71.0

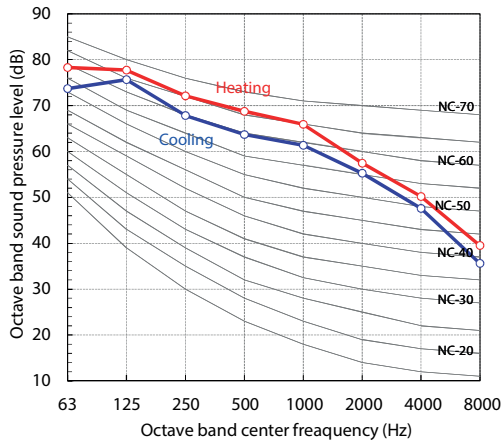

MMY-UP5811HT8P-E

Sound pressure Level (dB(A))	Cooling	Heating
	67.0	71.0

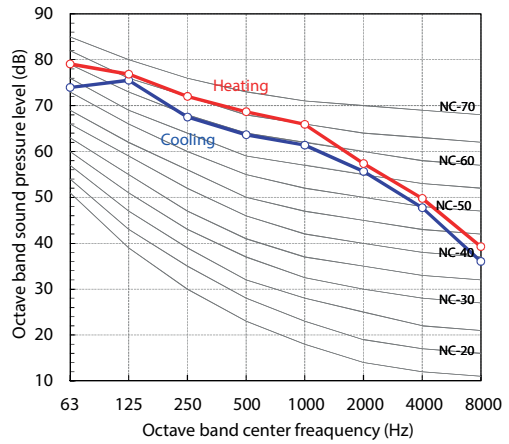

MMY-UP6011HT8P-E

Sound pressure Level (dB(A))	Cooling	Heating
	67.0	71.0

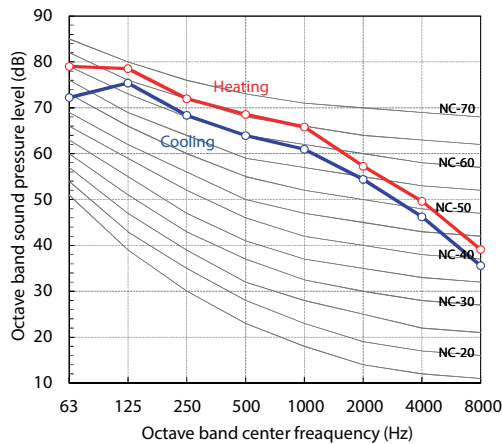

MMY-UP6211HT8P-E

Sound pressure Level (dB(A))	Cooling	Heating
	67.0	71.0

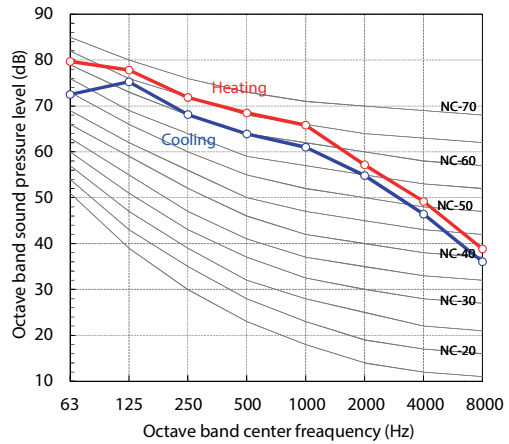

MMY-UP6411HT8P-E

Sound pressure Level (dB (A))	Cooling	Heating
	68.0	72.0

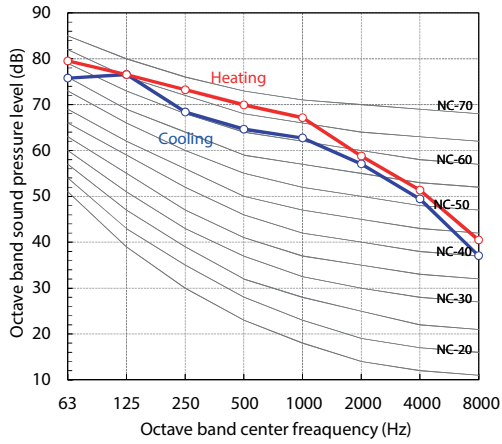

MMY-UP6611HT8P-E

Sound pressure Level (dB (A))	Cooling	Heating
	68.0	72.0

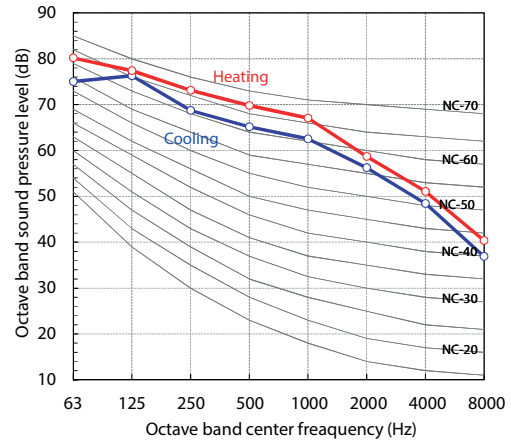

MMY-UP6811HT8P-E

Sound pressure Level (dB (A))	Cooling	Heating
	68.0	72.0

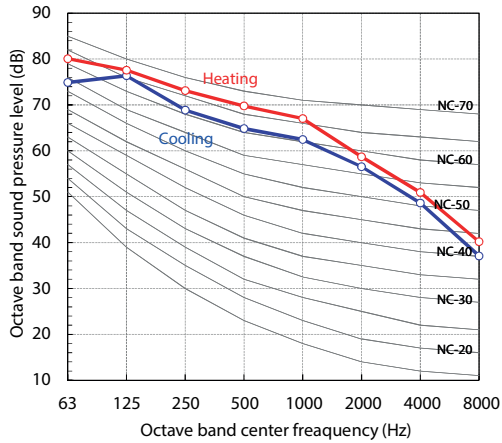

MMY-UP7011HT8P-E

Sound pressure Level (dB (A))	Cooling	Heating
	68.0	72.0

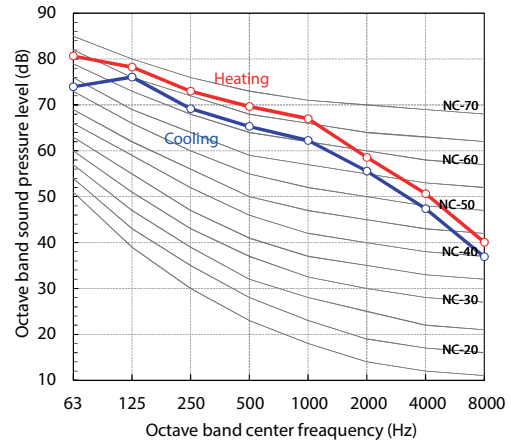

MMY-UP7211HT8P-E

Sound pressure Level (dB (A))	Cooling	Heating
	68.0	72.0

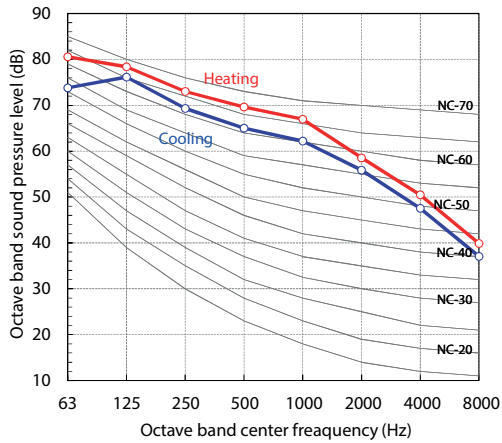

MMY-UP7411HT8P-E

Sound pressure Level (dB (A))	Cooling	Heating
	67.5	71.5

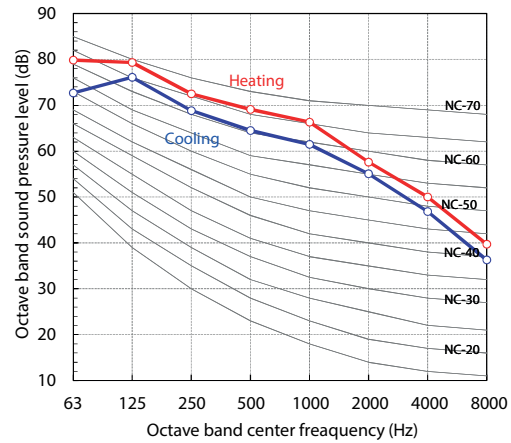

MMY-UP7611HT8P-E

Sound pressure Level (dB(A))	Cooling	Heating
	67.5	71.5

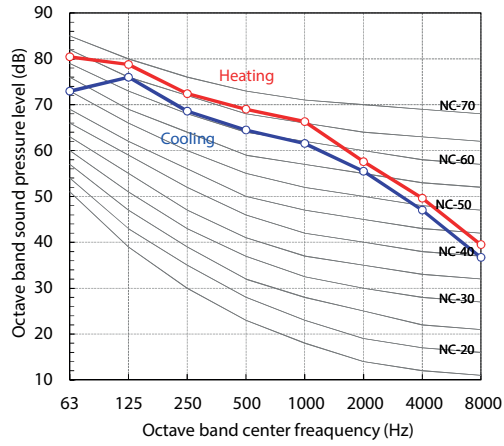

MMY-UP7811HT8P-E

Sound pressure Level (dB(A))	Cooling	Heating
	68.5	72.5

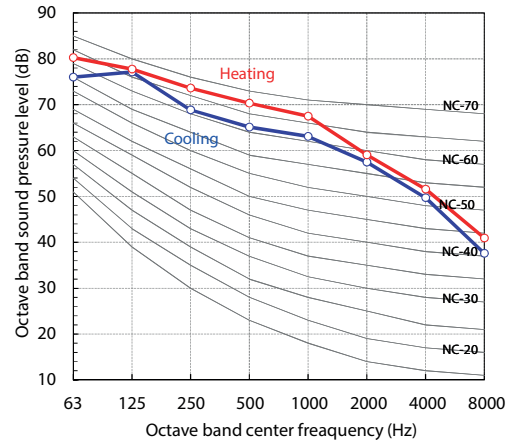

MMY-UP8011HT8P-E

Sound pressure Level (dB(A))	Cooling	Heating
	68.5	72.5

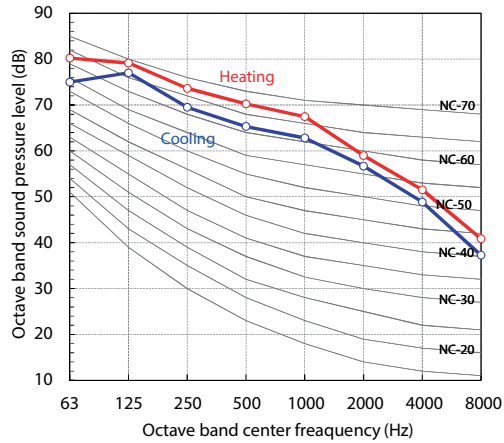

MMY-UP8211HT8P-E

Sound pressure Level (dB(A))	Cooling	Heating
	68.5	72.5

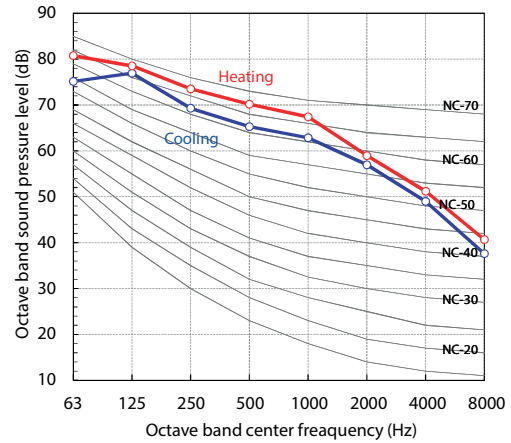

MMY-UP8411HT8P-E

Sound pressure Level (dB(A))	Cooling	Heating
	68.5	72.5

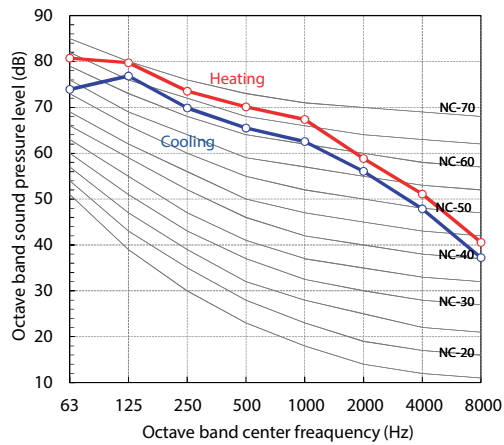

MMY-UP8611HT8P-E

Sound pressure Level (dB(A))	Cooling	Heating
	68.5	72.5

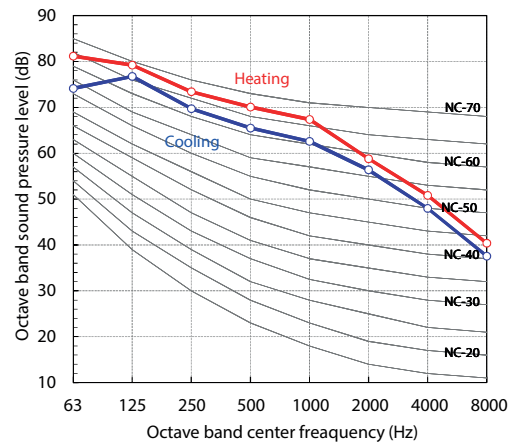

MMY-UP8811HT8P-E

Sound pressure Level (dB(A))	Cooling	Heating
	69.5	73.5

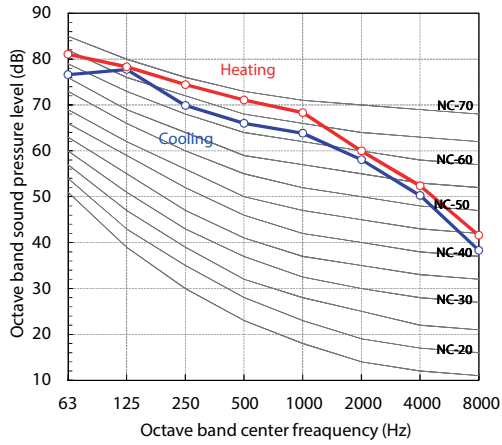

MMY-UP9011HT8P-E

Sound pressure Level (dB(A))	Cooling	Heating
	69.5	73.5

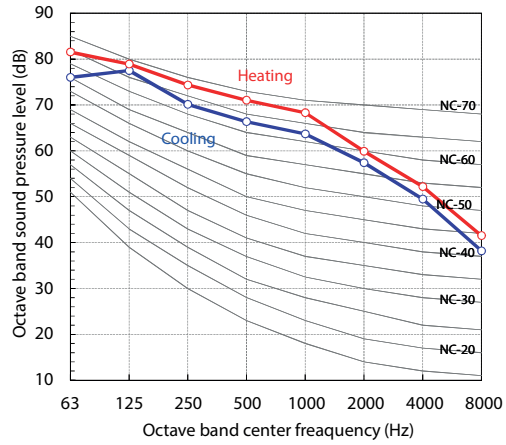

MMY-UP9211HT8P-E

Sound pressure Level (dB(A))	Cooling	Heating
	69.5	73.5

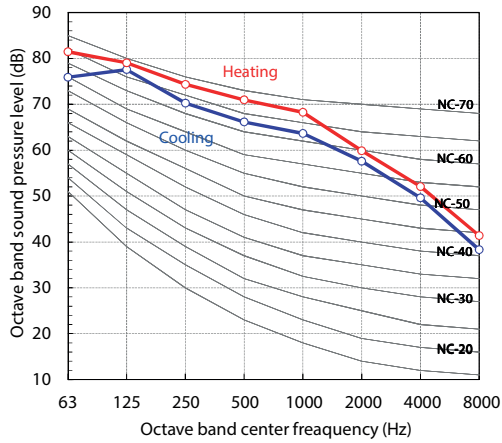

MMY-UP9411HT8P-E

Sound pressure Level (dB(A))	Cooling	Heating
	69.5	73.5

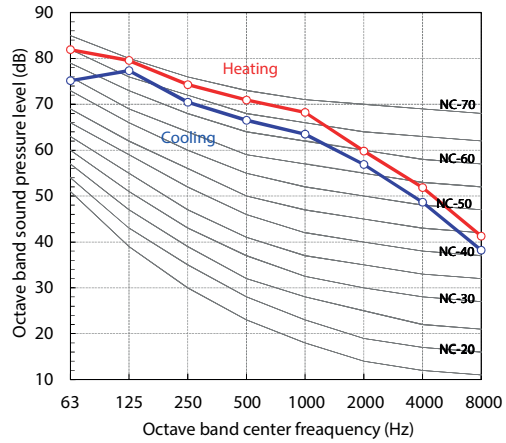

MMY-UP9611HT8P-E

Sound pressure Level (dB(A))	Cooling	Heating
	69.5	73.5

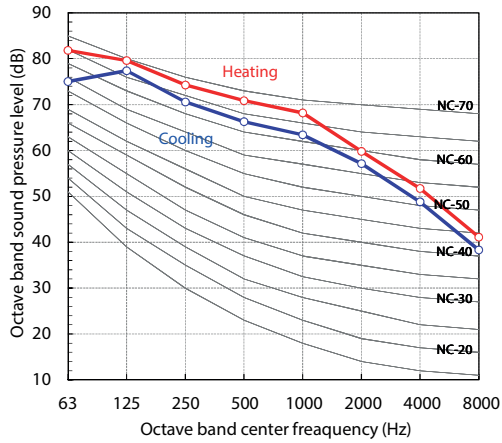

MMY-UP9811HT8P-E

Sound pressure Level (dB(A))	Cooling	Heating
	69.0	73.0

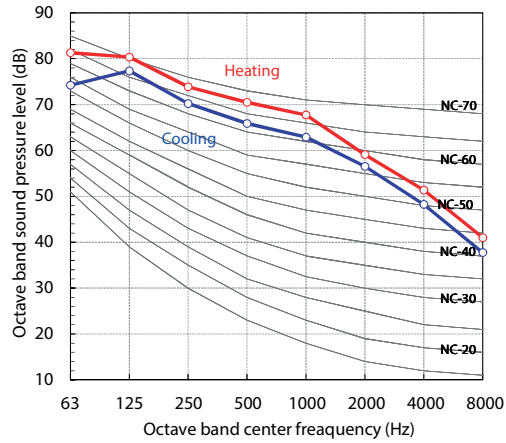

MMY-UP10011HT8P-E

Sound pressure Level (dB(A))	Cooling	Heating
	69.0	73.0

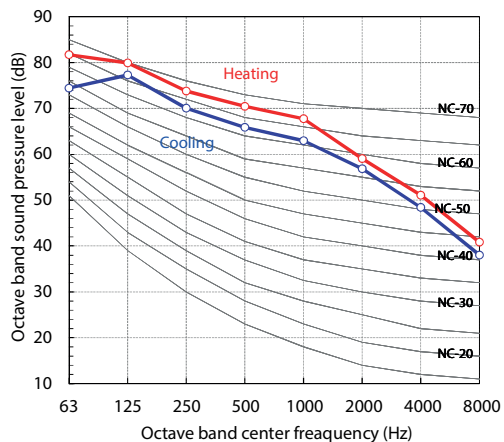

MMY-UP10211HT8P-E

Sound pressure Level (dB(A))	Cooling	Heating
	69.5	73.5

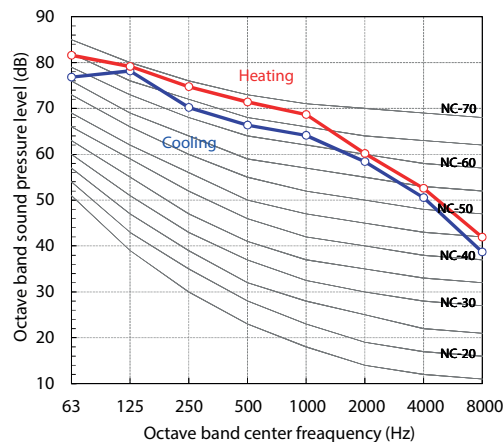

MMY-UP10411HT8P-E

Sound pressure Level (dB(A))	Cooling	Heating
	69.5	73.5

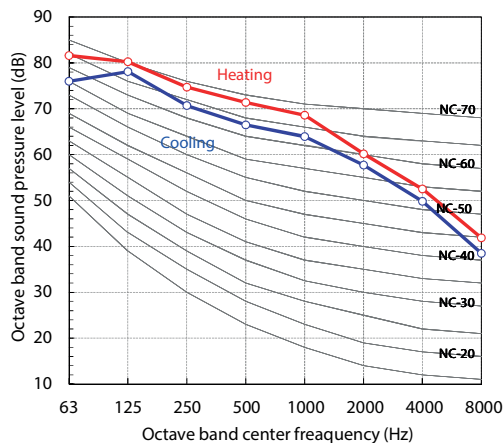

MMY-UP10611HT8P-E

Sound pressure Level (dB(A))	Cooling	Heating
	69.5	73.5

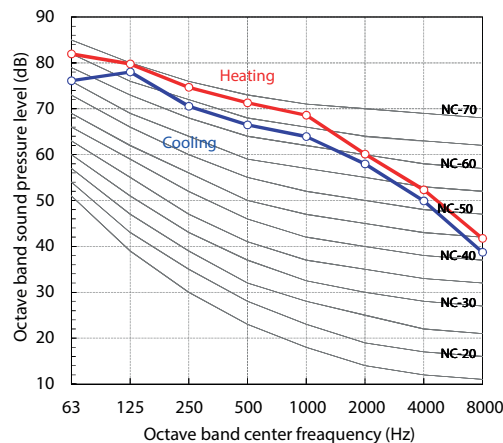

MMY-UP10811HT8P-E

Sound pressure Level (dB(A))	Cooling	Heating
	69.5	73.5

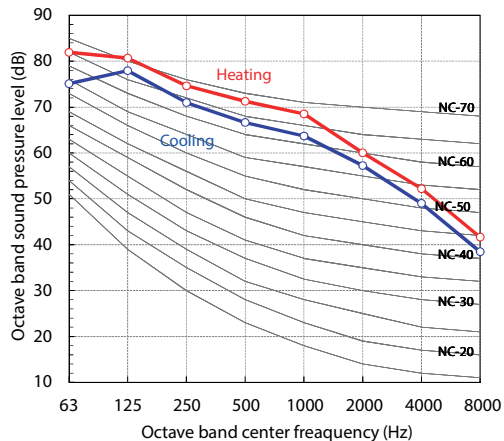

MMY-UP11011HT8P-E

Sound pressure Level (dB(A))	Cooling	Heating
	69.5	73.5

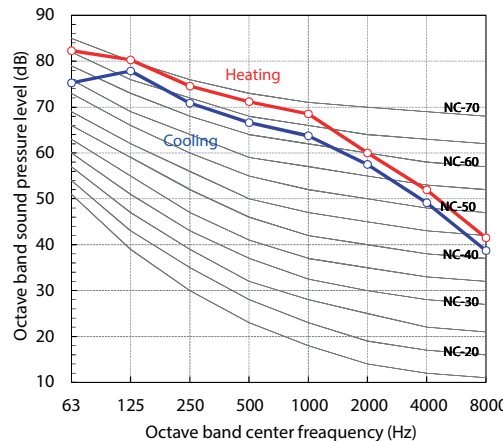

MMY-UP11211HT8P-E

Sound pressure Level (dB (A))	Cooling	Heating
	70.0	74.0

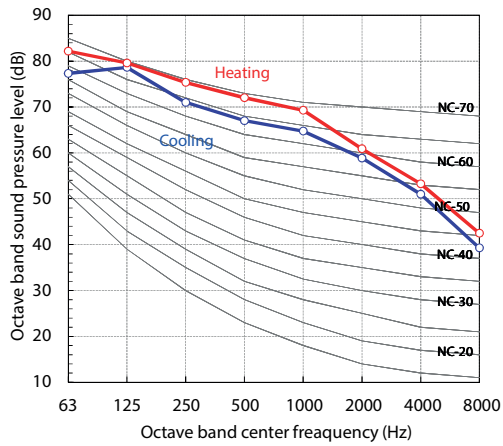

MMY-UP11411HT8P-E

Sound pressure Level (dB (A))	Cooling	Heating
	70.0	74.0

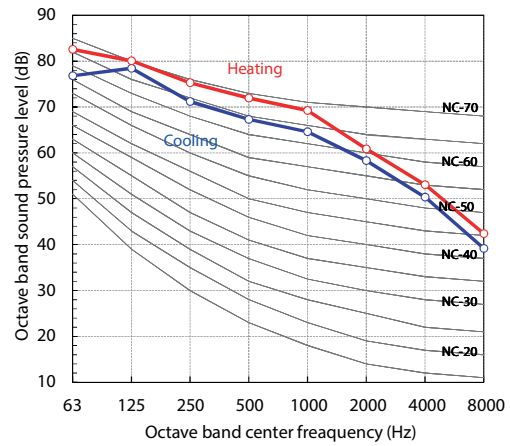

MMY-UP11611HT8P-E

Sound pressure Level (dB (A))	Cooling	Heating
	70.0	74.0

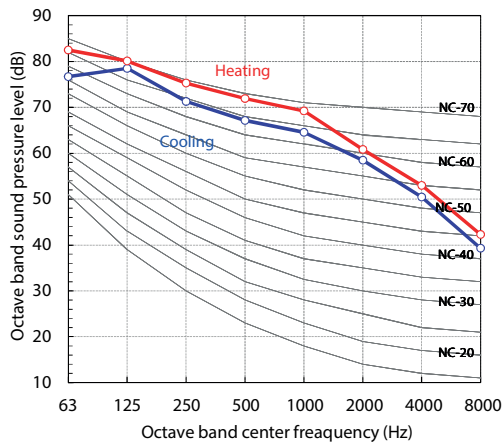

MMY-UP11811HT8P-E

Sound pressure Level (dB (A))	Cooling	Heating
	70.0	74.0

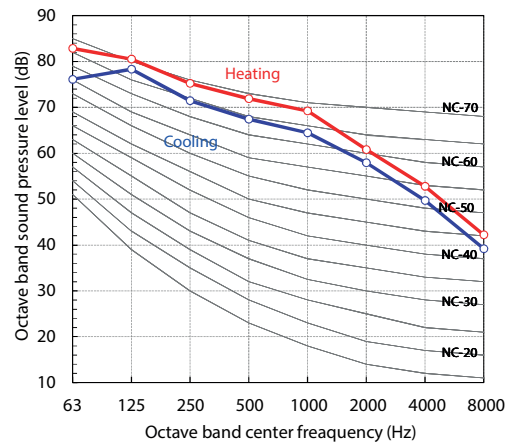

MMY-UP12011HT8P-E

Sound pressure Level (dB(A))	Cooling	Heating
	70.0	74.0

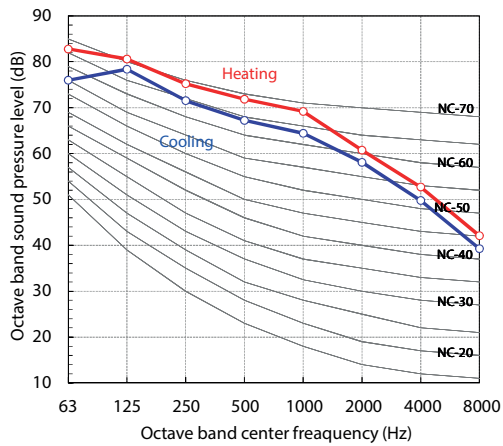

5-12. Sound data (NC curve - Night operation mode)

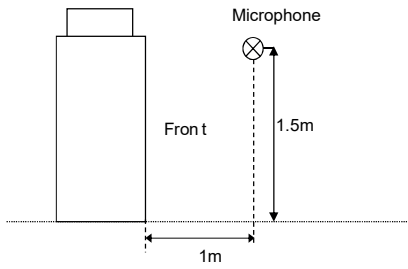

Standard model

MMY-MUP0801HT8P-E

Sound pressure Level (dB(A))	Cooling	Heating
	50.0	50.0

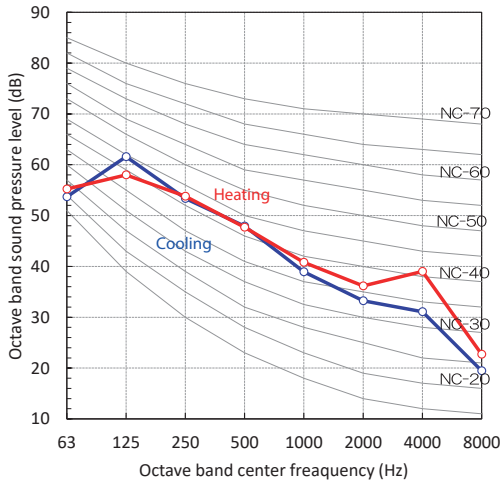

MMY-MUP1001HT8P-E

Sound pressure Level (dB(A))	Cooling	Heating
	50.0	50.0

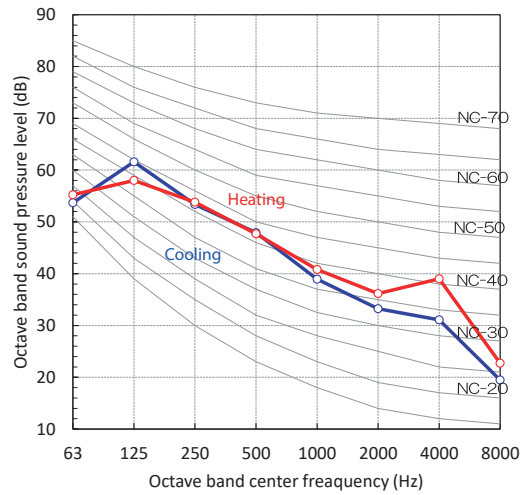

MMY-MUP1201HT8P-E

Sound pressure Level (dB(A))	Cooling	Heating
	50.0	50.0

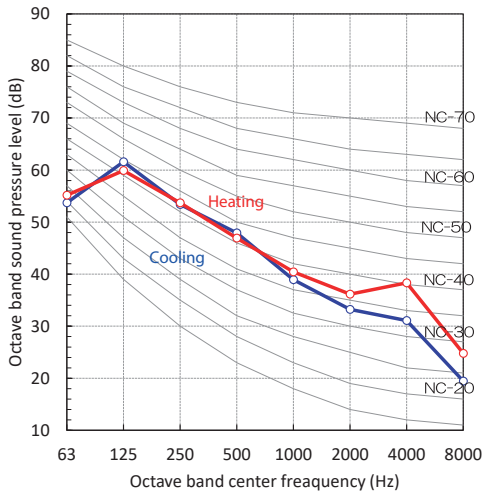

MMY-MUP1401HT8P-E

Sound pressure Level (dB(A))	Cooling	Heating
	50.0	50.0

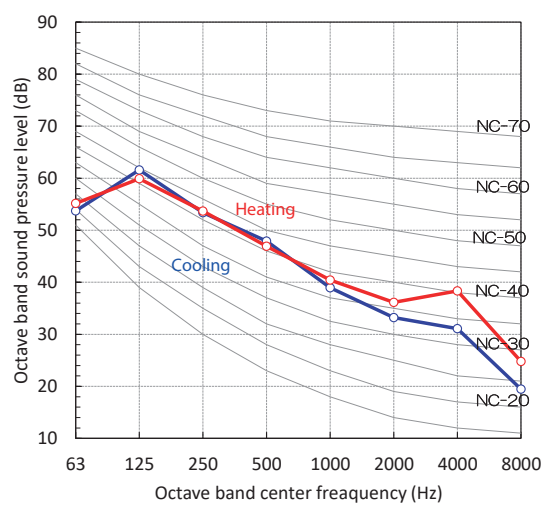

MMY-MUP1601HT8P-E

Sound pressure Level (dB(A))	Cooling	Heating
	53.0	53.0

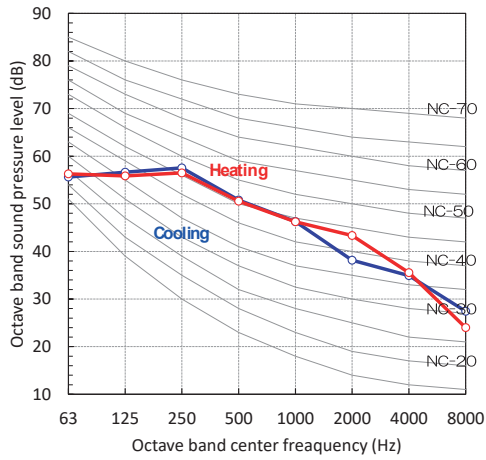

MMY-MUP1801HT8P-E

Sound pressure Level (dB(A))	Cooling	Heating
	54.0	54.0

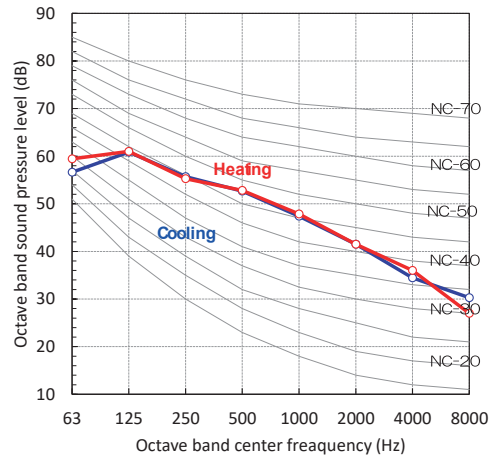

MMY-MUP2001HT8P-E

Sound pressure Level (dB(A))	Cooling	Heating
	54.0	54.0

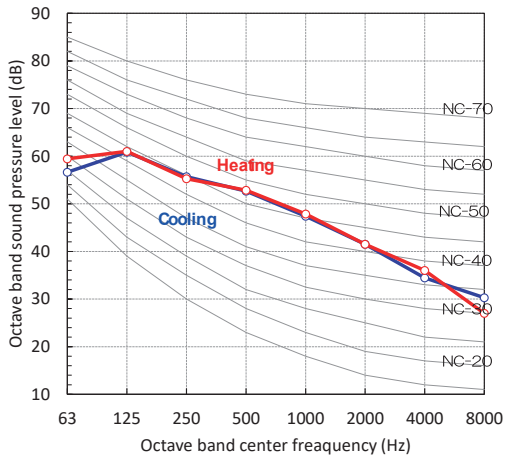

MMY-MUP2201HT8P-E

Sound pressure Level (dB(A))	Cooling	Heating
	52.0	54.0

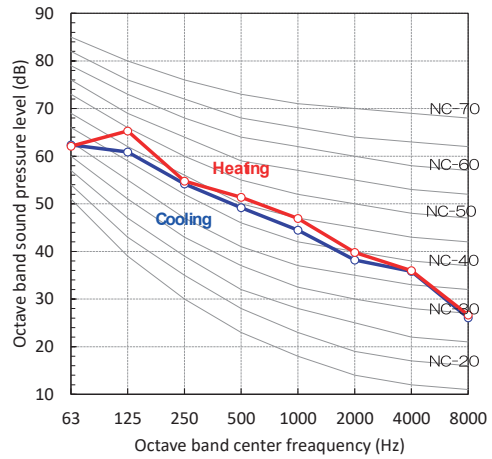

MMY-MUP2401HT8P-E1

Sound pressure Level (dB(A))	Cooling	Heating
	53.0	54.0

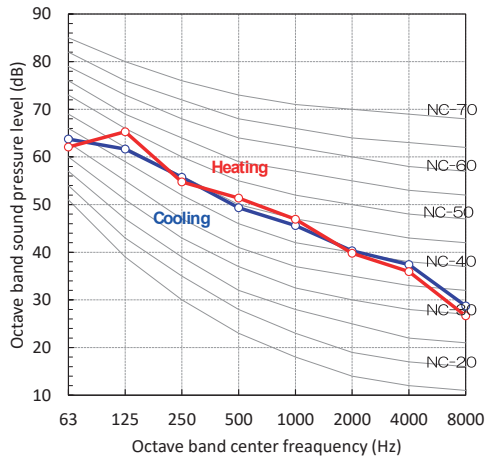

MMY-UP2611HT8P-E

Sound pressure Level (dB(A))	Cooling	Heating
	53.5	53.5

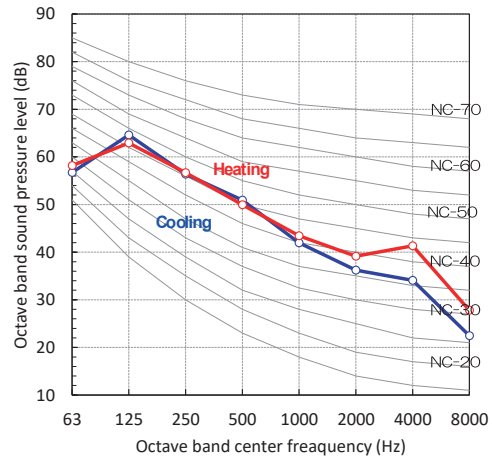

MMY-UP2811HT8P-E

Sound pressure Level (dB(A))	Cooling	Heating
	53.5	53.5

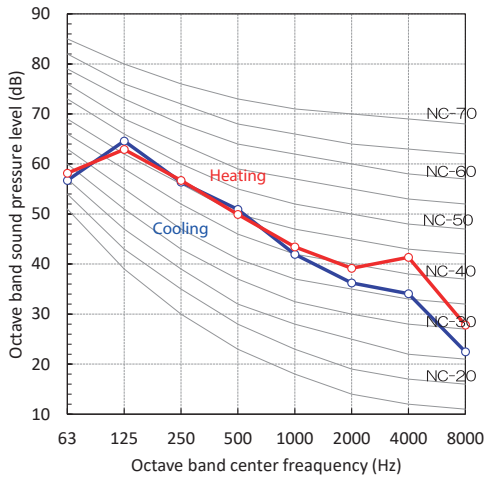

MMY-UP3011HT8P-E

Sound pressure Level (dB(A))	Cooling	Heating
	55.5	55.5

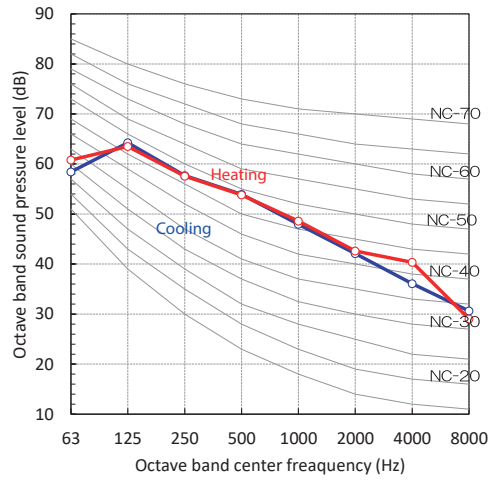

MMY-UP3211HT8P-E

Sound pressure Level (dB(A))	Cooling	Heating
	55.5	55.5

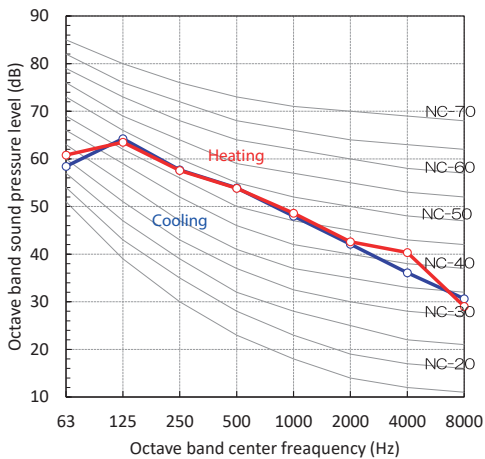

MMY-UP3411HT8P-E

Sound pressure Level (dB(A))	Cooling	Heating
	55.5	55.5

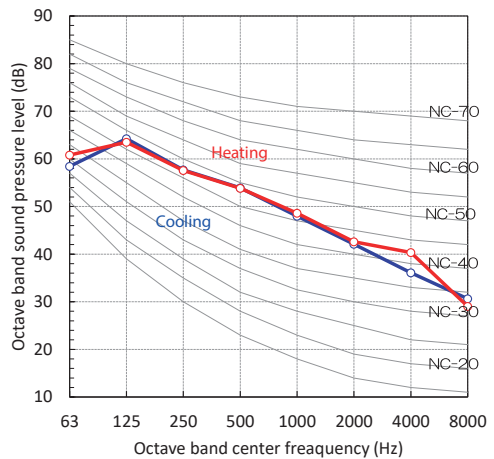

MMY-UP3611HT8P-E

Sound pressure Level (dB(A))	Cooling	Heating
	55.0	55.5

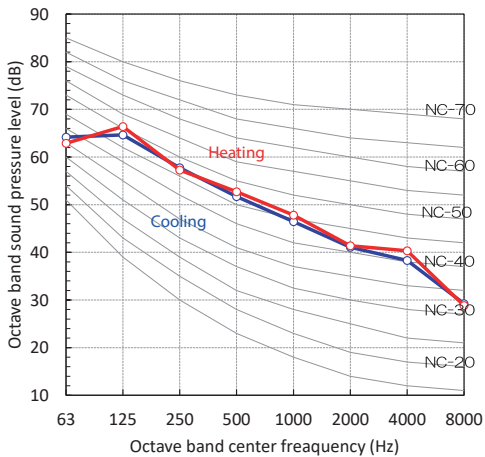

MMY-UP3811HT8P-E

Sound pressure Level (dB(A))	Cooling	Heating
	55.0	55.5

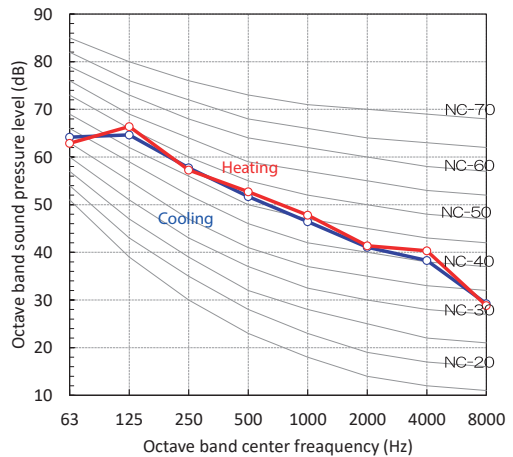

MMY-UP4011HT8P-E

Sound pressure Level (dB(A))	Cooling	Heating
	57.5	57.5

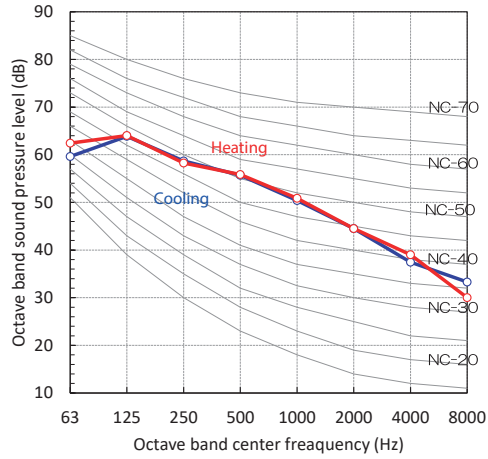

MMY-UP4211HT8P-E

Sound pressure Level (dB(A))	Cooling	Heating
	57.0	57.5

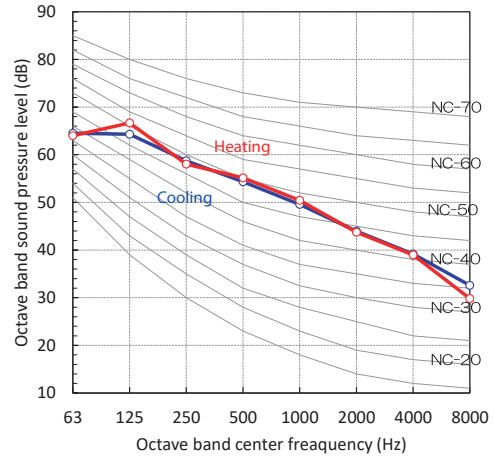

MMY-UP4411HT8P-E

Sound pressure Level (dB(A))	Cooling	Heating
	57.0	57.5

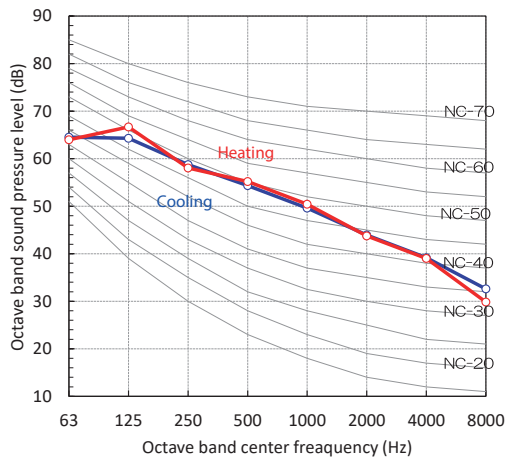

MMY-UP4611HT8P-E

Sound pressure Level (dB(A))	Cooling	Heating
	56.0	57.5

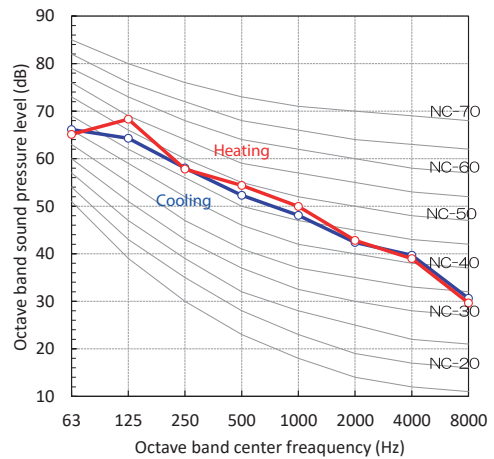

MMY-UP4811HT8P-E

Sound pressure Level (dB(A))	Cooling	Heating
	56.5	57.5

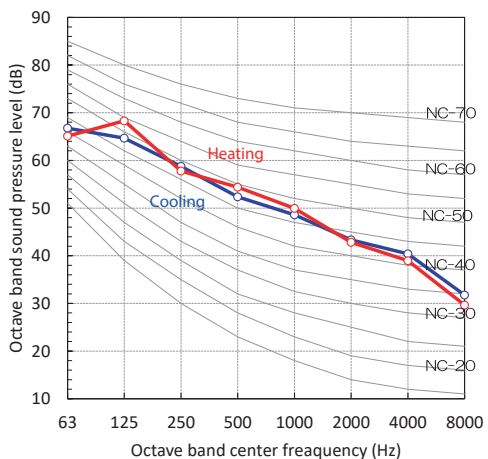

MMY-UP5011HT8P-E

Sound pressure Level (dB(A))	Cooling	Heating
	56.5	57.0

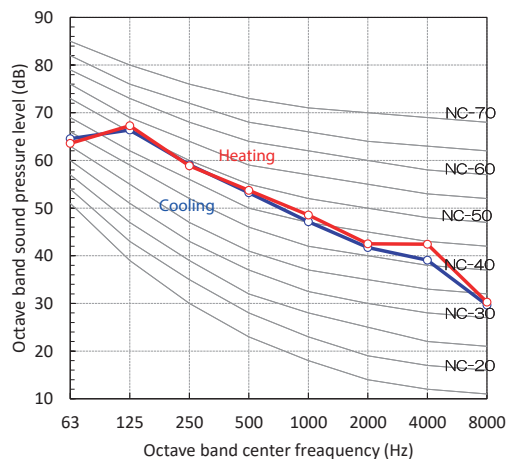

MMY-UP5211HT8P-E

Sound pressure Level (dB(A))	Cooling	Heating
	56.5	57.0

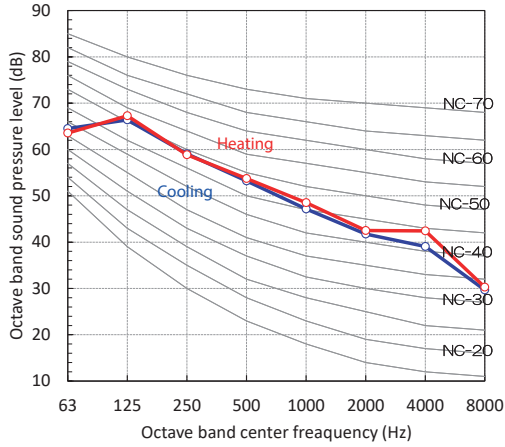

MMY-UP5411HT8P-E

Sound pressure Level (dB(A))	Cooling	Heating
	58.0	58.0

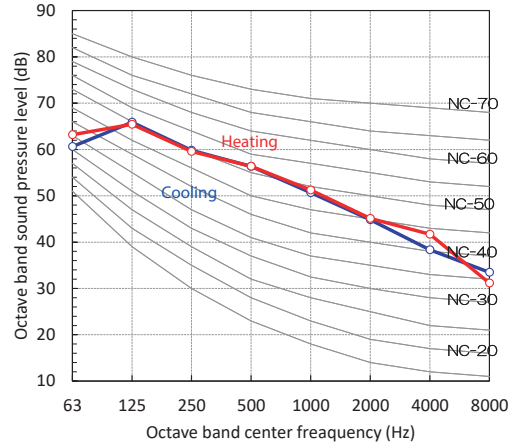

MMY-UP5611HT8P-E

Sound pressure Level (dB(A))	Cooling	Heating
	57.5	58.0

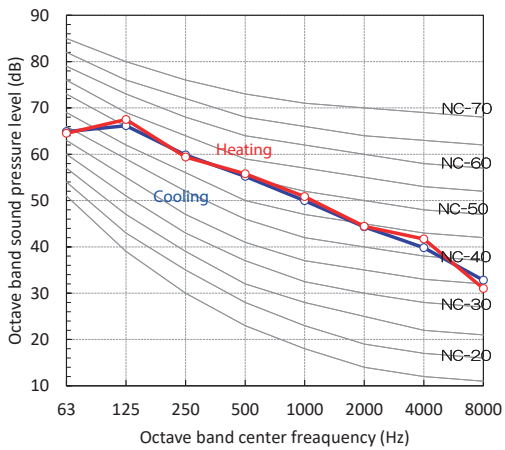

MMY-UP5811HT8P-E

Sound pressure Level (dB(A))	Cooling	Heating
	57.5	58.0

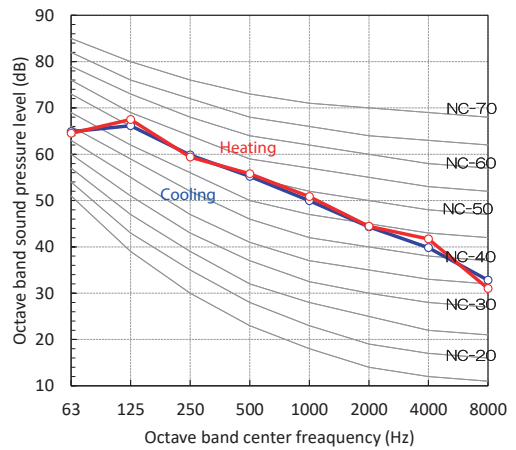

MMY-UP6011HT8P-E

Sound pressure Level (dB(A))	Cooling	Heating
	57.0	58.0

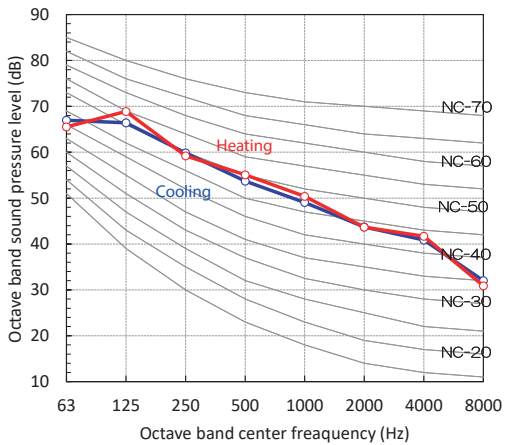

MMY-UP6211HT8P-E

Sound pressure Level (dB(A))	Cooling	Heating
	57.0	58.0

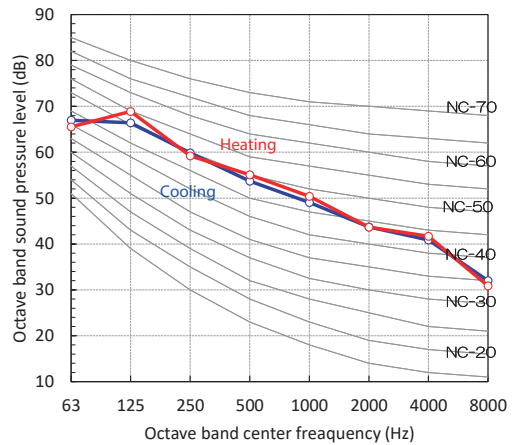

MMY-UP6411HT8P-E

Sound pressure Level (dB(A))	Cooling	Heating
	58.5	59.0

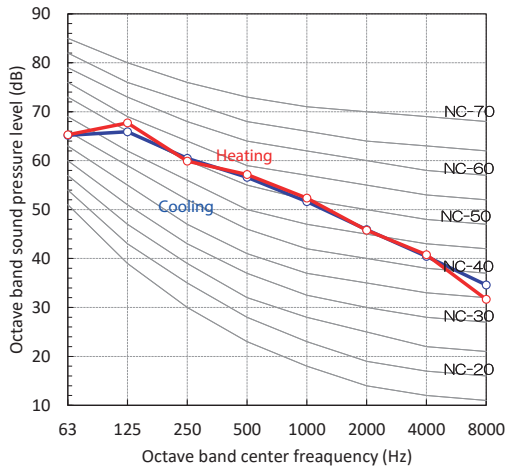

MMY-UP6611HT8P-E

Sound pressure Level (dB(A))	Cooling	Heating
	58.0	59.0

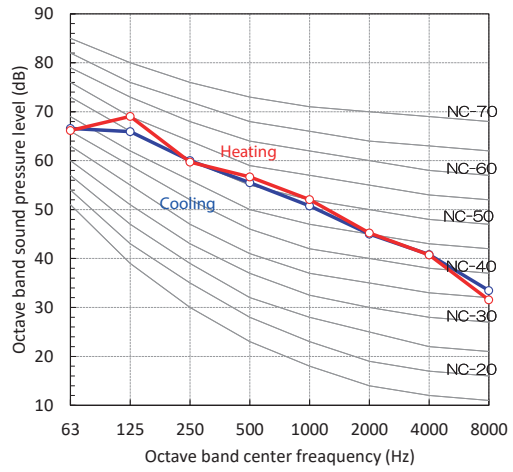

MMY-UP6811HT8P-E

Sound pressure Level (dB(A))	Cooling	Heating
	58.5	59.0

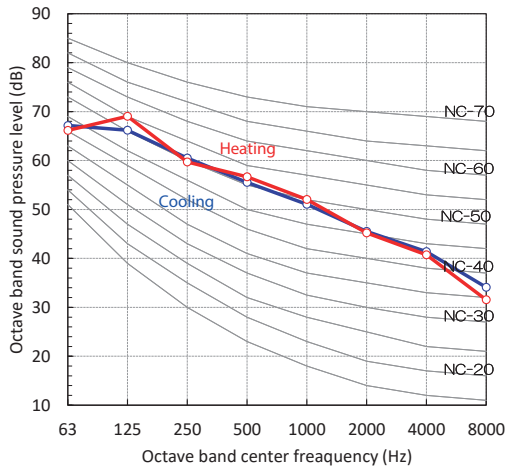

MMY-UP7011HT8P-E

Sound pressure Level (dB(A))	Cooling	Heating
	57.5	59.0

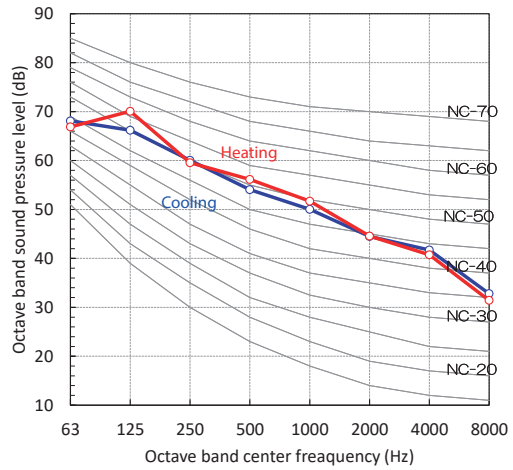

MMY-UP7211HT8P-E

Sound pressure Level (dB(A))	Cooling	Heating
	58.0	59.0

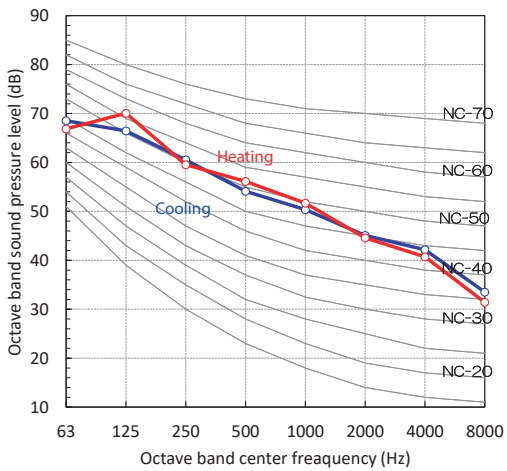

MMY-UP7411HT8P-E

Sound pressure Level (dB(A))	Cooling	Heating
	58.0	58.5

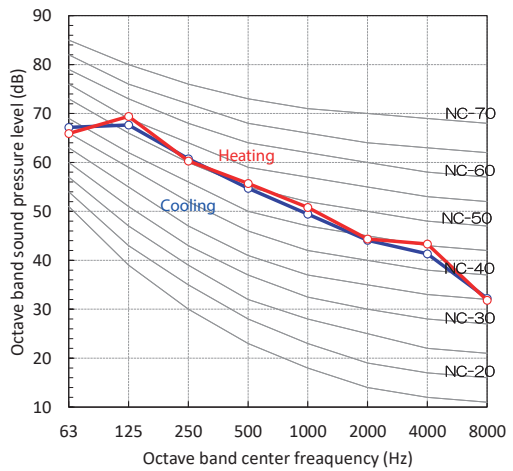

MMY-UP7611HT8P-E

Sound pressure Level (dB(A))	Cooling	Heating
	58.0	58.5

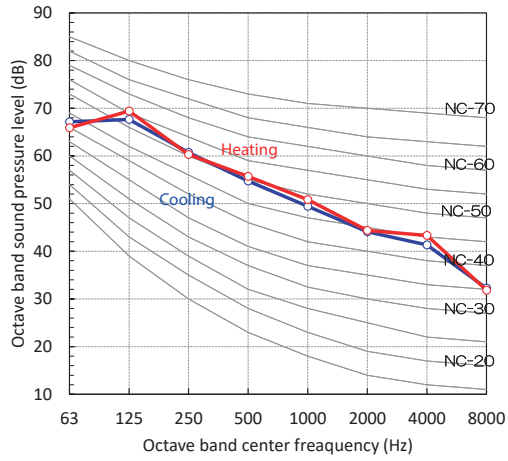

MMY-UP7811HT8P-E

Sound pressure Level (dB(A))	Cooling	Heating
	59.5	59.5

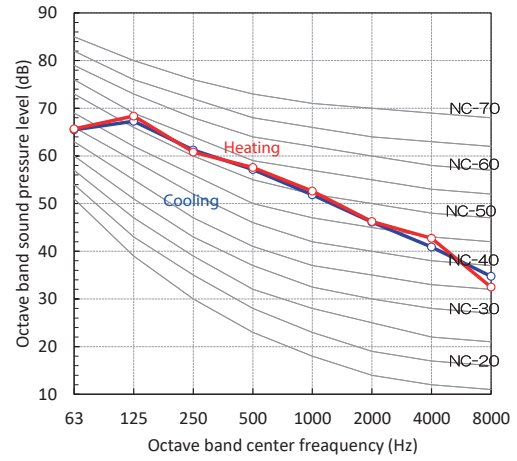

MMY-UP8011HT8P-E

Sound pressure Level (dB(A))	Cooling	Heating
	59.0	59.5

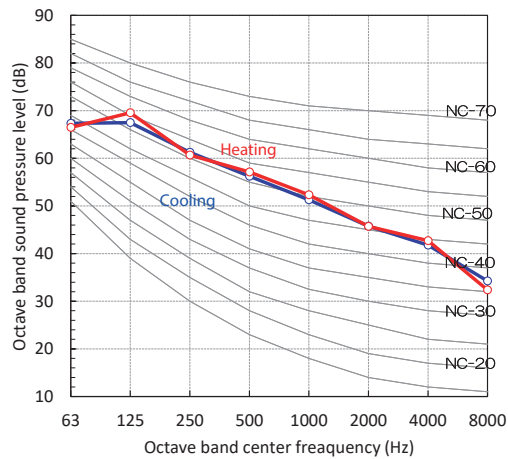

MMY-UP8211HT8P-E

Sound pressure Level (dB(A))	Cooling	Heating
	59.0	59.5

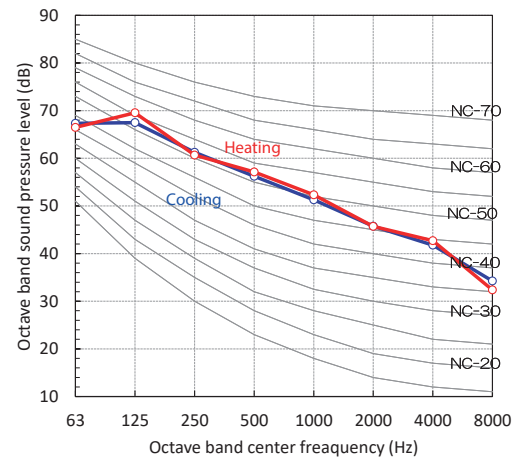

MMY-UP8411HT8P-E

Sound pressure Level (dB(A))	Cooling	Heating
	58.5	59.5

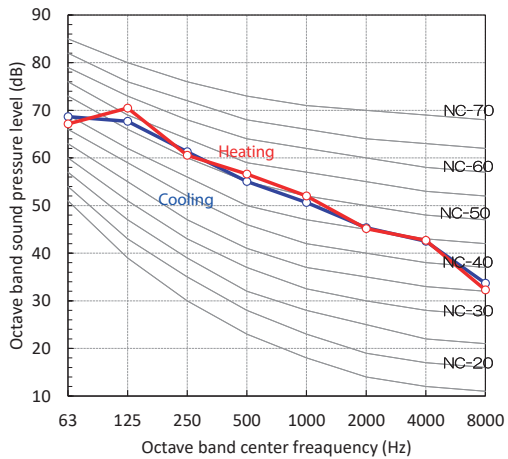

MMY-UP8611HT8P-E

Sound pressure Level (dB(A))	Cooling	Heating
	58.5	59.5

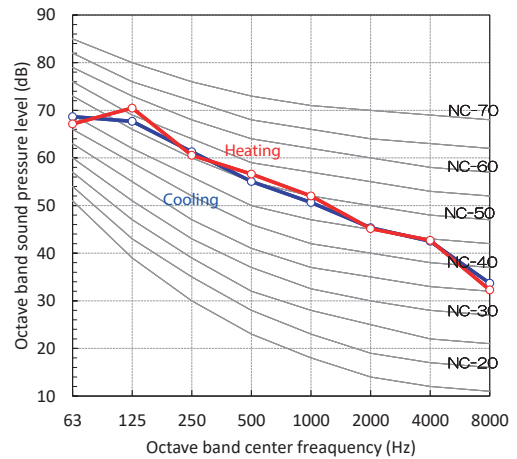

MMY-UP8811HT8P-E

Sound pressure Level (dB(A))	Cooling	Heating
	60.0	60.5

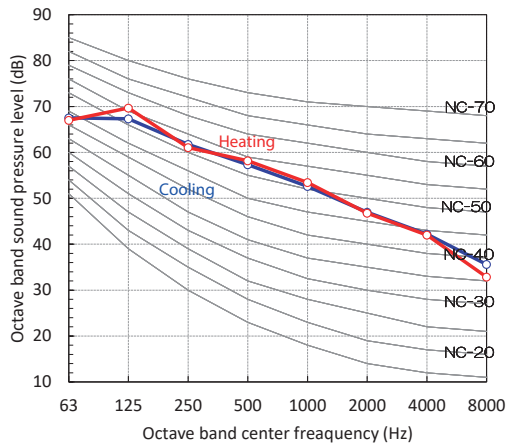

MMY-UP9011HT8P-E

Sound pressure Level (dB(A))	Cooling	Heating
	59.5	60.5

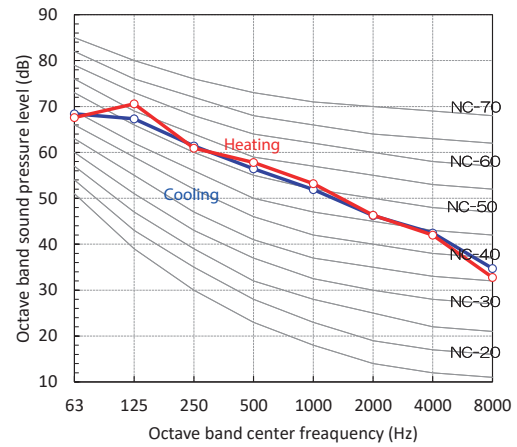

MMY-UP9211HT8P-E

Sound pressure Level (dB(A))	Cooling	Heating
	59.5	60.5

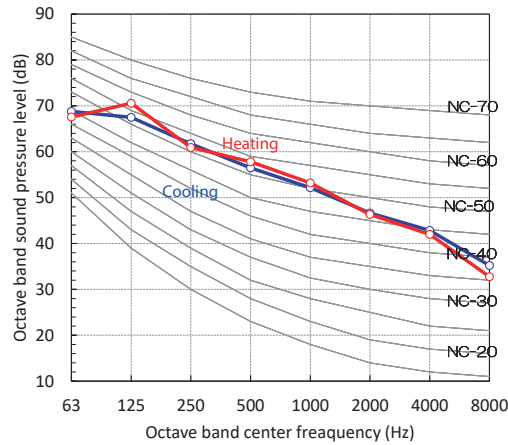

MMY-UP9411HT8P-E

Sound pressure Level (dB(A))	Cooling	Heating
	59.0	60.5

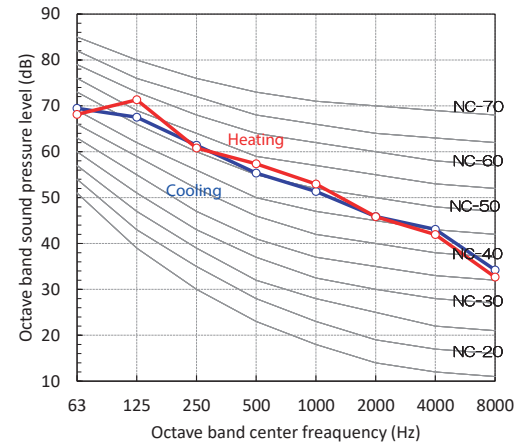

MMY-UP9611HT8P-E

Sound pressure Level (dB(A))	Cooling	Heating
	59.5	60.5

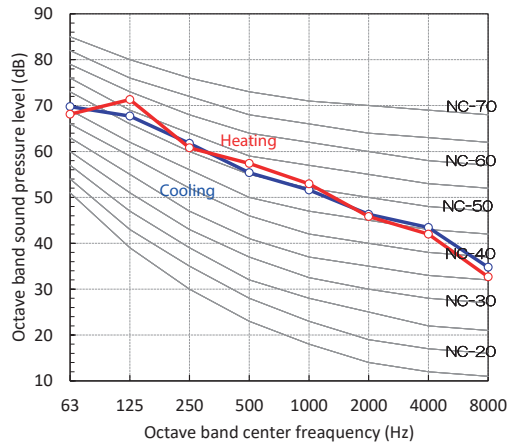

MMY-UP9811HT8P-E

Sound pressure Level (dB(A))	Cooling	Heating
	59.5	60.0

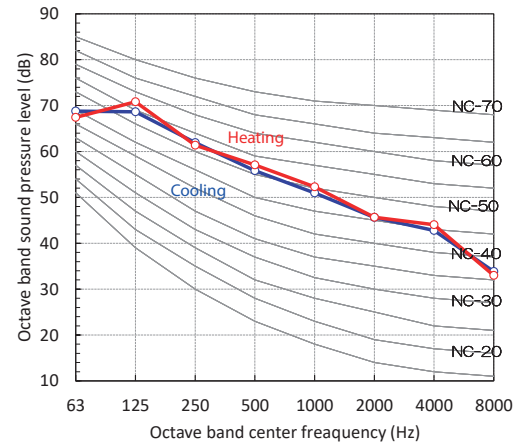

MMY-UP10011HT8P-E

Sound pressure Level (dB(A))	Cooling	Heating
	59.5	60.0

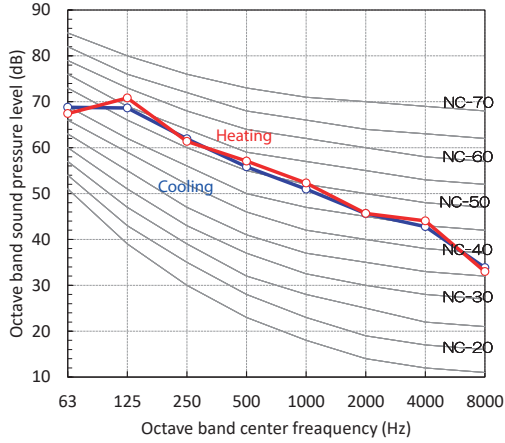

MMY-UP10211HT8P-E

Sound pressure Level (dB(A))	Cooling	Heating
	60.5	60.5

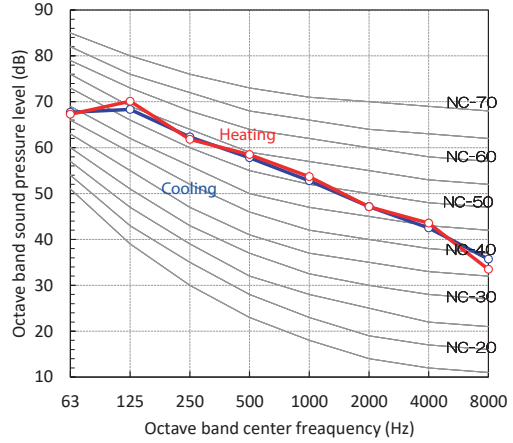

MMY-UP10411HT8P-E

Sound pressure Level (dB(A))	Cooling	Heating
	60.0	60.5

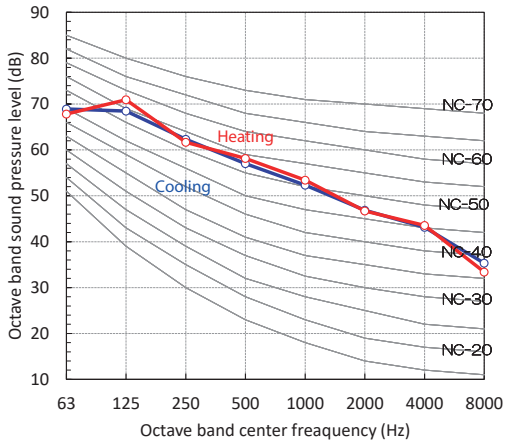

MMY-UP10611HT8P-E

Sound pressure Level (dB(A))	Cooling	Heating
	60.0	60.5

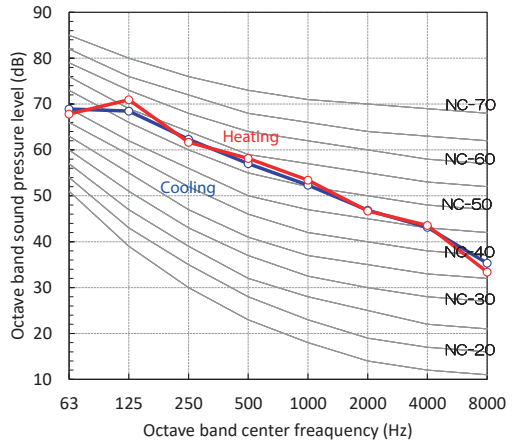

MMY-UP10811HT8P-E

Sound pressure Level (dB(A))	Cooling	Heating
	60.0	60.5

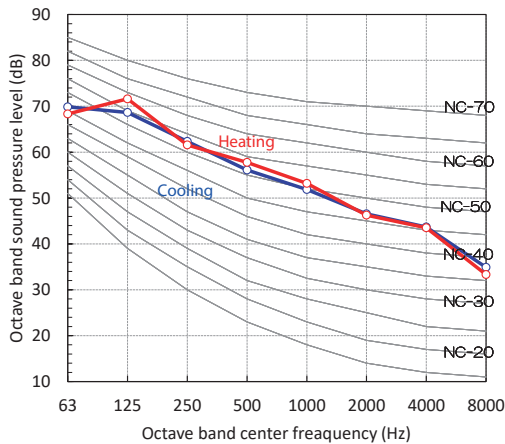

MMY-UP11011HT8P-E

Sound pressure Level (dB(A))	Cooling	Heating
	60.0	60.5

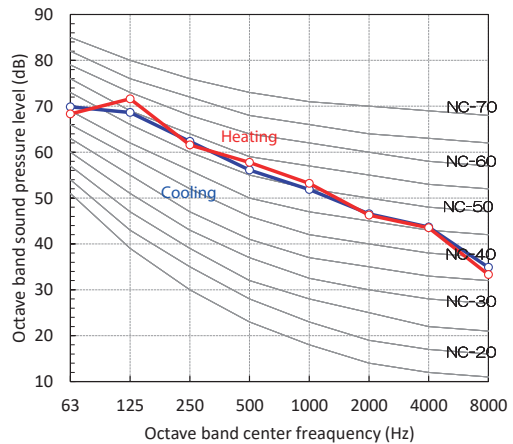

MMY-UP11211HT8P-E

Sound pressure Level (dB(A))	Cooling	Heating
	60.5	61.0

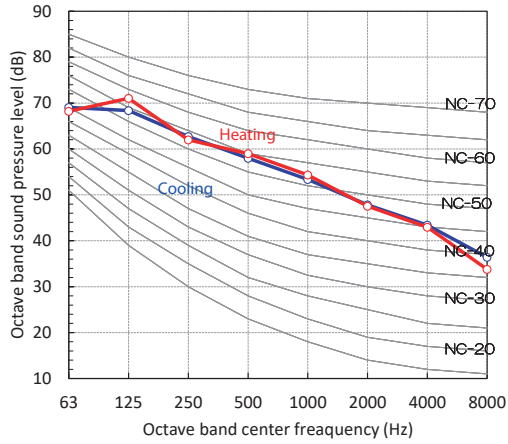

MMY-UP11411HT8P-E

Sound pressure Level (dB(A))	Cooling	Heating
	60.5	61.0

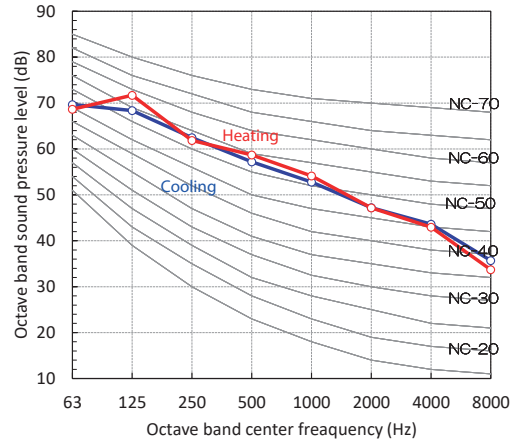

MMY-UP11611HT8P-E

Sound pressure Level (dB(A))	Cooling	Heating
	60.5	61.0

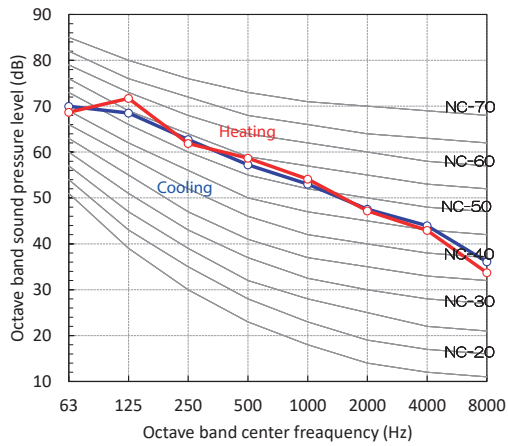

MMY-UP11811HT8P-E

Sound pressure Level (dB(A))	Cooling	Heating
	60.0	61.0

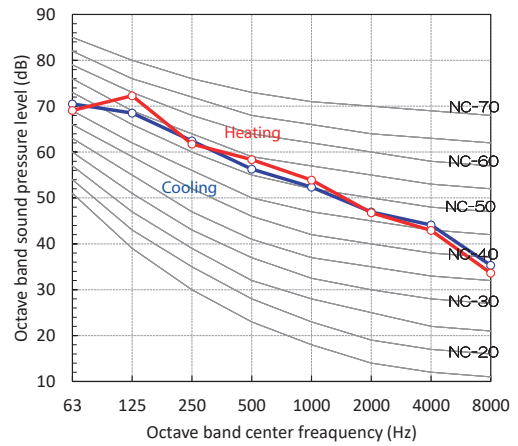

MMY-UP12011HT8P-E

Sound pressure Level (dB(A))	Cooling	Heating
	60.0	61.0

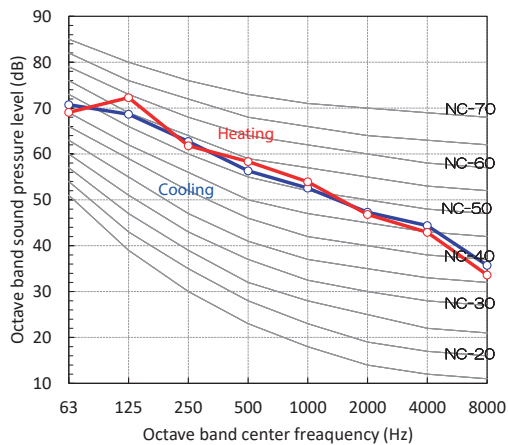

6. PMV Kit

PMV-Kit (RBM-PMV0361U-E, RBM-PMV0901U-E) shall be required for quieter place application as an optional to reduce refrigerant sound especially in oil retrieval control or in transient operation as start up.

6-1. Selection

Model name	Indoor unit capacity type	Diameter of refrigerant pipe
RBM-PMV0361U-E	005 to 012 type	ø6.4
RBM-PMV0901U-E	014 to 018 type	ø6.4
	020 to 034 type	ø9.5

Allowable length of refrigerant piping

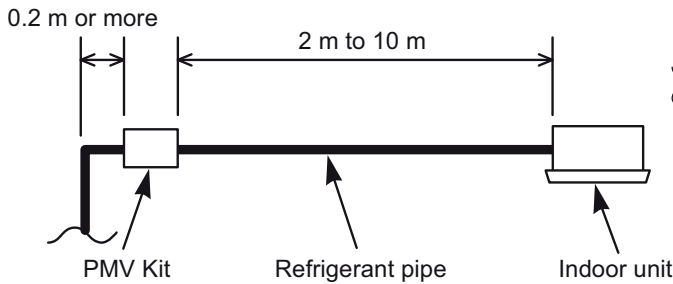

The straight pipe section should be at least 0.2 m as shown in the figure below.

* Short length of the straight pipe section may cause abnormal sounds.

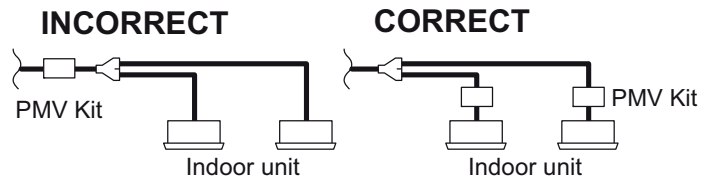

Note)

Do not connect two or more indoor units to one PMV Kit. Arrange one indoor unit and one PMV Kit set to 1 by 1.

Label

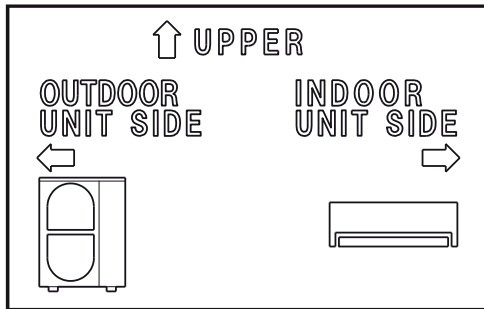

• **Connecting direction of refrigerant pipe**

When connecting pipes, be careful of direction of the main unit. Be sure to install the main unit so that [UPPER] mark on the label directs upward. For connection of the refrigerant pipes, follow the arrow mark on the label and connect pipes after confirming directions of the indoor unit and the outdoor unit.

Piping material and dimensions

Model name	Indoor unit capacity type	Diameter of refrigerant pipe	Notes
RBM-PMV0361U-E	005, 007, 009, 012 type	6.4	
RBM-PMV0901U-E	014, 015, 018 type	6.4	
	020, 024, 027, 030, 034 type	9.5	

CAUTION

When connecting ø9.5 refrigerant pipes, be sure to insert a seal pipe between PMV main unit and the joint. If the seal pipe is not inserted, refrigerant leakage is caused.



6-2. Wiring connections

For this product, the connector conversion cable and additional clamp filter (Accessory) are used according to the indoor unit to be connected.

For the corresponding unit and how to use the conversion cable and clamp filter, refer to the following description.

The connector conversion cable is not used for the indoor unit, but the additional clamp filter is used.

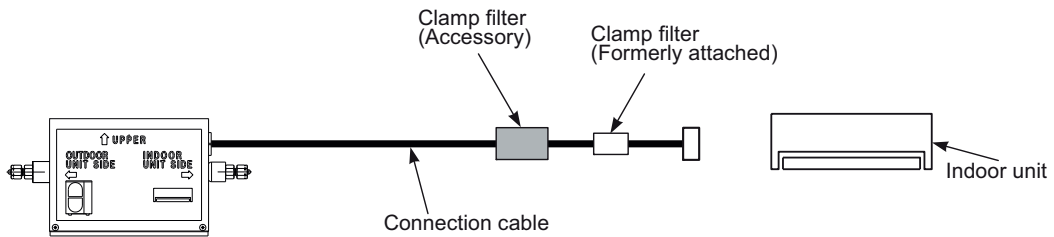

- Remove an existing PMV lead wire connecting to the connector (CN82) on the P.C.board in the indoor unit, and replace it with the PMV kit connection wire (approximately 11 m).

The additional clamp filter is not used for the indoor unit, but the connector conversion cable is used.

Indoor unit except above indoor units

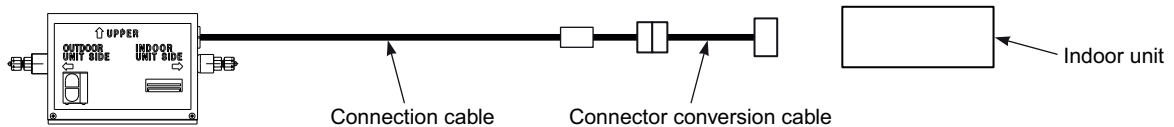

6-3. Dimensional drawing

- PMV Kit
- RBM-PMV0361U-E, RBM-PMV0901U-E

Unit (mm)

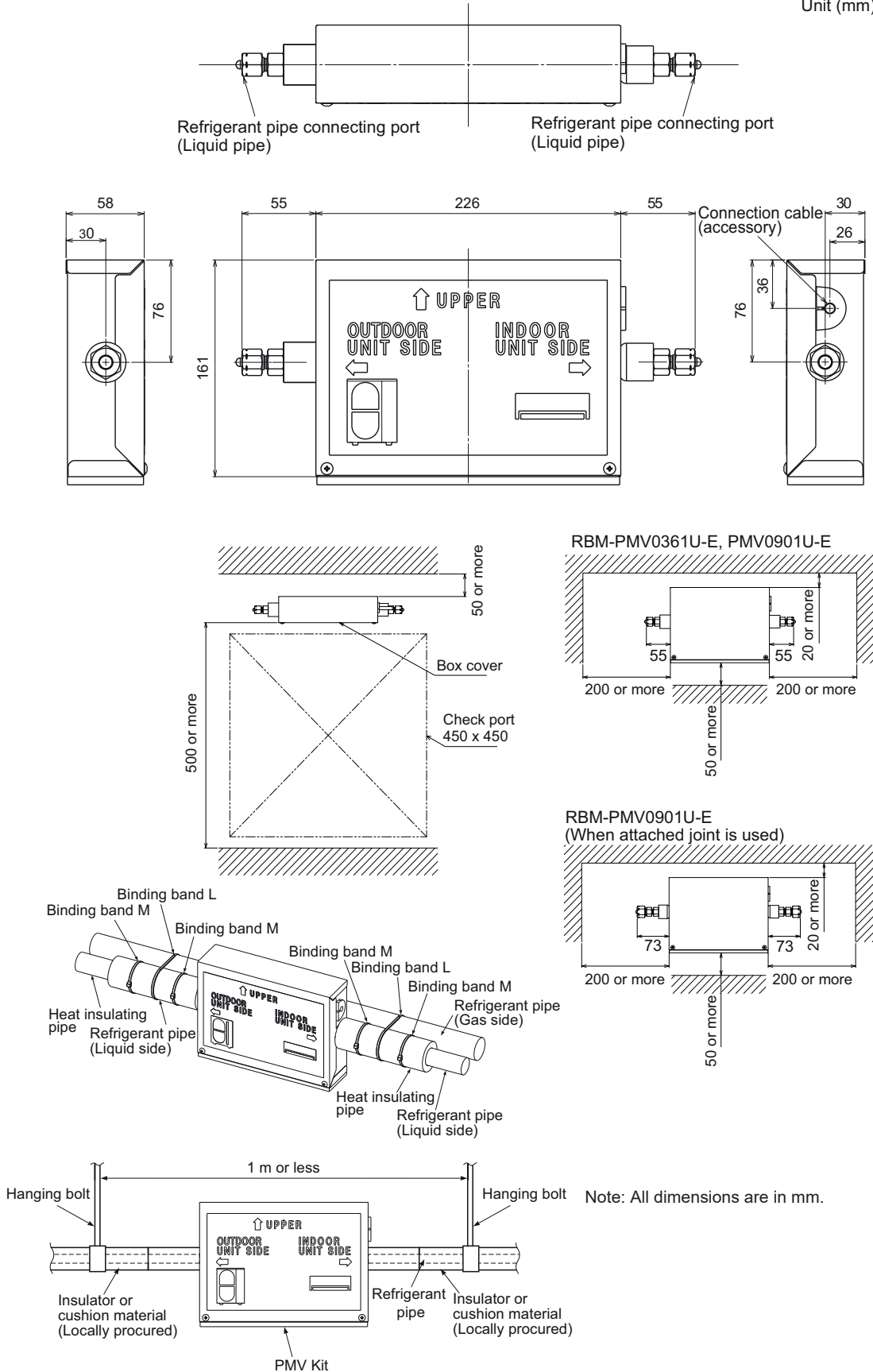

Note: All dimensions are in mm.

SMMS-u Engineering Data Book

Model name:

MMY-MUP_1HT8P-E

October, 2023 Revision 10

Toshiba Carrier Corporation