

FICHE TECHNIQUE PRODUIT

Gainable haute pression DRV : MMD-UP0241HP-E



PRESSION DISPONIBLE
MAX.



COMPACTITÉ
TAILLES 018 À 056



POMPE DE RELEVAGE
INTÉGRÉE
TAILLES 018 À 056

Gammes DRV	SMMSu	SMMSe	SHRMe	Mini-SMMSe
Compatibilités	✓	✓	✓	✓

Référence		MMD-UP0241HP-E
Puissance frigorifique (35°C ext./27°C int.)	kW	7,1
Puissance calorifique (+7°C ext./20°C int.)	kW	8,0
Code puissance	CV	2,5
Puissance absorbée	kW	0,14
Intensité	A	0,92
Intensité de démarrage	A	1,55
Débit d'air (GV/PV)	m3/h	1200 / 960
Niveau de pression sonore à 1,5m (GV/MV/PV)	dB(A)	38 / 34 / 31
Dimensions (H x L x P)	mm	298 x 1000 x 750
Poids	kg	34
Pression disponible	Pa	7 niveaux : de 50 à 200 (réglage usine = 100)
Liaisons frigorifiques (gaz-liquide)	pouce	5/8 - 3/8
Diamètre extérieur des condensats	mm	32
Alimentation électrique	V-ph-Hz	220/240-1-50



toshiba-confort.fr

0810 723 723 Service 0,05 € / appel + prix appel

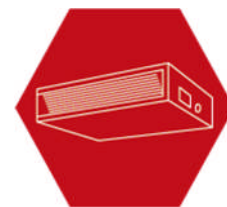

Dimensions :

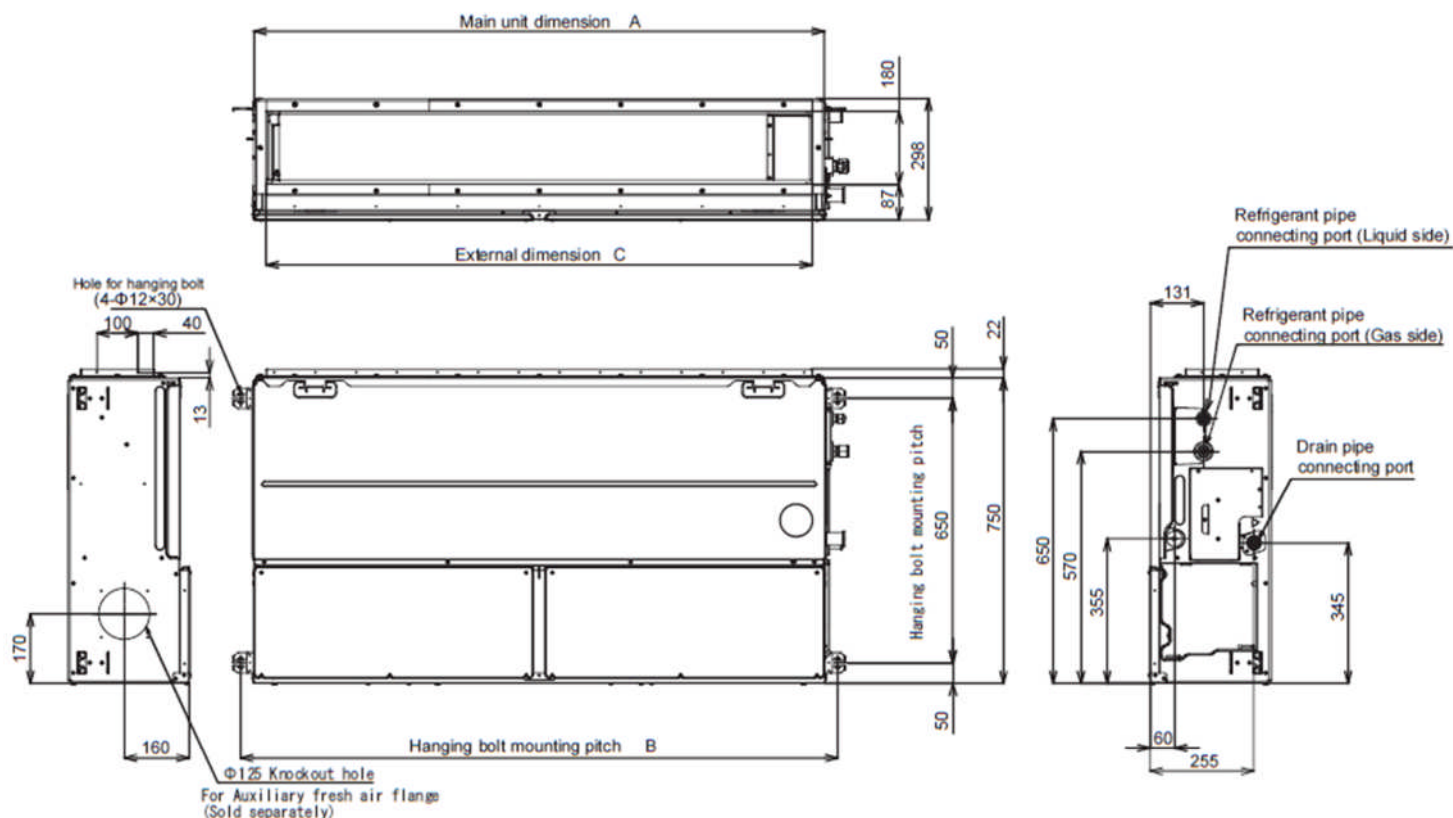

Unit dimension	A	B	C	D
UP018 ~ 027 type	1000	1065	940	500
UP0 36~ 056 type	1400	1465	1340	700

