



EB99832901

TOSHIBA

AIR CONDITIONER (SPLIT TYPE) Installation Manual

R32 or R410A

For commercial use

Indoor Unit

Model name:

Floor Standing Type

RAV-RM561FT-EN

RAV-RM801FT-EN

RAV-RM1101FT-EN

RAV-RM1401FT-EN

RAV-RM1601FT-EN

RAV-RM561FT-ES

RAV-RM801FT-ES

RAV-RM1101FT-ES

RAV-RM1401FT-ES

RAV-RM1601FT-ES



For details of setting up remote controller built in this unit, refer to the separate Owner's Manual and Installation Manual of remote controller. This Installation Manual describes only major items.

Original instruction

Please read this Installation Manual carefully before installing the Air Conditioner.

- This Manual describes the installation method of the indoor unit.
- For installation of the outdoor unit, follow the Installation Manual attached to the outdoor unit.

ADOPTION OF R32 or R410A REFRIGERANT

This Air Conditioner has adopted a refrigerant HFC (R32 or R410A) which does not destroy the ozone layer. Be sure to check the refrigerant type for outdoor unit to be combined, and then install it.

Product information of ecodesign requirements. (Regulation (EU) 2016/2281)
<http://ecodesign.toshiba-airconditioning.eu/en>

Contents

1	Precautions for safety	3
1	Précautions relatives à la sécurité	9
1	Vorsichtsmaßnahmen für die Sicherheit	15
1	Precauzioni per la sicurezza	21
1	Precauciones de seguridad	27
1	Precauções de segurança	33
1	Voorzorgen voor de veiligheid	39
1	Προφυλάξεις για ασφάλεια	45
1	Меры предосторожности	51
2	Accessory parts	55
3	Selection of installation place	55
4	Installation	57
5	Drain piping	59
6	Refrigerant piping	60
7	Electrical connection	62
8	Applicable controls	64
9	Test run	69
10	Maintenance	70
11	Troubleshooting	72

Thank you for purchasing this Toshiba air conditioner. Please read carefully through these instructions including important information which complies with the "Machinery Directive" (Directive 2006/42/EC), and ensure that you understand them. After reading these instructions, be sure to keep them in a safe place together with the Owner's Manual and Installation Manual supplied with your product.

Generic Denomination: Air Conditioner

Definition of Qualified Installer or Qualified Service Person

The air conditioner must be installed, maintained, repaired and removed by a qualified installer or qualified service person. When any of these jobs is to be done, ask a qualified installer or qualified service person to do them for you. A qualified installer or qualified service person is an agent who has the qualifications and knowledge described in the table below.

Agent	Qualifications and knowledge which the agent must have
Qualified installer	<ul style="list-style-type: none"> • The qualified installer is a person who installs, maintains, relocates and removes the air conditioners made by Toshiba Carrier Corporation. He or she has been trained to install, maintain, relocate and remove the air conditioners made by Toshiba Carrier Corporation or, alternatively, he or she has been instructed in such operations by an individual or individuals who have been trained and is thus thoroughly acquainted with the knowledge related to these operations. • The qualified installer who is allowed to do the electrical work involved in installation, relocation and removal has the qualifications pertaining to this electrical work as stipulated by the local laws and regulations, and he or she is a person who has been trained in matters relating to electrical work on the air conditioners made by Toshiba Carrier Corporation or, alternatively, he or she has been instructed in such matters by an individual or individuals who have been trained and is thus thoroughly acquainted with the knowledge related to this work. • The qualified installer who is allowed to do the refrigerant handling and piping work involved in installation, relocation and removal has the qualifications pertaining to this refrigerant handling and piping work as stipulated by the local laws and regulations, and he or she is a person who has been trained in matters relating to refrigerant handling and piping work on the air conditioners made by Toshiba Carrier Corporation or, alternatively, he or she has been instructed in such matters by an individual or individuals who have been trained and is thus thoroughly acquainted with the knowledge related to this work. • The qualified installer who is allowed to work at heights has been trained in matters relating to working at heights with the air conditioners made by Toshiba Carrier Corporation or, alternatively, he or she has been instructed in such matters by an individual or individuals who have been trained and is thus thoroughly acquainted with the knowledge related to this work.
Qualified service person	<ul style="list-style-type: none"> • The qualified service person is a person who installs, repairs, maintains, relocates and removes the air conditioners made by Toshiba Carrier Corporation. He or she has been trained to install, repair, maintain, relocate and remove the air conditioners made by Toshiba Carrier Corporation or, alternatively, he or she has been instructed in such operations by an individual or individuals who have been trained and is thus thoroughly acquainted with the knowledge related to these operations. • The qualified service person who is allowed to do the electrical work involved in installation, repair, relocation and removal has the qualifications pertaining to this electrical work as stipulated by the local laws and regulations, and he or she is a person who has been trained in matters relating to electrical work on the air conditioners made by Toshiba Carrier Corporation or, alternatively, he or she has been instructed in such matters by an individual or individuals who have been trained and is thus thoroughly acquainted with the knowledge related to this work. • The qualified service person who is allowed to do the refrigerant handling and piping work involved in installation, repair, relocation and removal has the qualifications pertaining to this refrigerant handling and piping work as stipulated by the local laws and regulations, and he or she is a person who has been trained in matters relating to refrigerant handling and piping work on the air conditioners made by Toshiba Carrier Corporation or, alternatively, he or she has been instructed in such matters by an individual or individuals who have been trained and is thus thoroughly acquainted with the knowledge related to this work. • The qualified service person who is allowed to work at heights has been trained in matters relating to working at heights with the air conditioners made by Toshiba Carrier Corporation or, alternatively, he or she has been instructed in such matters by an individual or individuals who have been trained and is thus thoroughly acquainted with the knowledge related to this work.

Definition of Protective Gear

When the air conditioner is to be transported, installed, maintained, repaired or removed, wear protective gloves and "safety" work clothing.

In addition to such normal protective gear, wear the protective gear described below when undertaking the special work detailed in the table below.

Failure to wear the proper protective gear is dangerous because you will be more susceptible to injury, burns, electric shocks and other injuries.

Work undertaken	Protective gear worn
All types of work	Protective gloves "Safety" working clothing
Electrical-related work	Clothing to provide protection from electric shock Insulating shoes Gloves to provide protection from electric shock
Work done at heights (50 cm or more)	Helmets for use in industry
Transportation of heavy objects	Shoes with additional protective toecap
Repair of outdoor unit	Gloves to provide protection from electric shock

Center of gravity

Model name	X (mm)	Y (mm)	Z (mm)
RAV-RM561FT-EN/ES	85	285	820
RAV-RM801FT-EN/ES			
RAV-RM1101FT-EN/ES	195	290	860
RAV-RM1401FT-EN/ES			
RAV-RM1601FT-EN/ES			

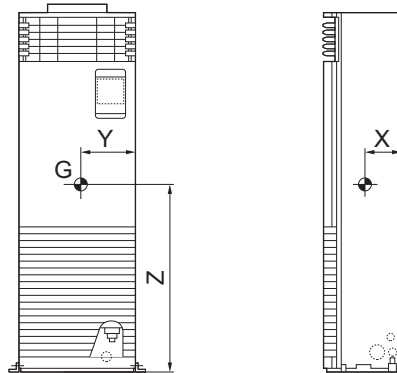

Warning indications on the air conditioner unit

These safety cautions describe important matters concerning safety to prevent injury to users or other people and damages to property. Please read through this manual after understanding the contents below (meanings of indications), and be sure to follow the description.



Indication	Meaning of Indication
WARNING	Text set off in this manner indicates that failure to adhere to the directions in the warning could result in serious bodily harm (*1) or loss of life if the product is handled improperly.
CAUTION	Text set off in this manner indicates that failure to adhere to the directions in the caution could result in slight injury (*2) or damage (*3) to property if the product is handled improperly.

*1: Serious bodily harm indicates loss of eyesight, injury, burns, electric shock, bone fracture, poisoning, and other injuries which leave aftereffect and require hospitalization or long-term treatment as an outpatient.

*2: Slight injury indicates injury, burns, electric shock, and other injuries which do not require hospitalization or long-term treatment as an outpatient.

*3: Damage to property indicates damage extending to buildings, household effects, domestic livestock, and pets.

	WARNING (Risk of fire)	This mark is for R32 refrigerant only. Refrigerant type is written on nameplate of outdoor unit. In case that refrigerant type is R32, this unit uses a flammable refrigerant. If refrigerant leaks and comes in contact with fire or heating part, it will create harmful gas and there is risk of fire.
		Read the OWNER'S MANUAL carefully before operation.
		Service personnel are required to carefully read the OWNER'S MANUAL and INSTALLATION MANUAL before operation.
		Further information is available in the OWNER'S MANUAL, INSTALLATION MANUAL, and the like.

Warning indication	Description
 <p>WARNING ELECTRICAL SHOCK HAZARD Disconnect all remote electric power supplies before servicing.</p>	<p>WARNING ELECTRICAL SHOCK HAZARD Disconnect all remote electric power supplies before servicing.</p>
 <p>WARNING Moving parts. Do not operate unit with grille removed. Stop the unit before the servicing.</p>	<p>WARNING Moving parts. Do not operate unit with grille removed. Stop the unit before the servicing.</p>
 <p>CAUTION Do not touch the aluminum fins of the unit. Doing so may result in injury.</p>	<p>CAUTION Do not touch the aluminium fins of the unit. Doing so may result in injury.</p>

1 Precautions for safety

The manufacturer shall not assume any liability for the damage caused by not observing the description of this manual.

WARNING

General

- Before starting to install the air conditioner, read through the Installation Manual carefully, and follow its instructions to install the air conditioner.
- Only a qualified installer or service person is allowed to do installation work. Inappropriate installation may result in water leakage, electric shock or fire.
- Do not use any refrigerant different from the one specified for complement or replacement. Otherwise, abnormally high pressure may be generated in the refrigeration cycle, which may result in a failure or explosion of the product or an injury to your body.
- Before opening the intake grille of the indoor unit or service panel of the outdoor unit, set the circuit breaker to the OFF position. Failure to set the circuit breaker to the OFF position may result in electric shocks through contact with the interior parts. Only a qualified installer (*1) or qualified service person (*1) is allowed to remove the intake grille of the indoor unit or service panel of the outdoor unit and do the work required.
- Before carrying out the installation, maintenance, repair or removal work, set the circuit breaker to the OFF position. Otherwise, electric shocks may result.
- Place a “Work in progress” sign near the circuit breaker while the installation, maintenance, repair or removal work is being carried out. There is a danger of electric shocks if the circuit breaker is set to ON by mistake.
- Only a qualified installer (*1) or qualified service person (*1) is allowed to undertake work at heights using a stand of 50 cm or more or to remove the intake grille of the indoor unit to undertake work.
- Wear protective gloves and safety work clothing during installation, servicing and removal.
- Do not touch the aluminium fin of the unit. You may injure yourself if you do so. If the fin must be touched for some reason, first put on protective gloves and safety work clothing, and then proceed.

- When work is performed at heights, use a ladder which complies with the ISO 14122 standard, and follow the procedure in the ladder's instructions. Also wear a helmet for use in industry as protective gear to undertake the work.
- This unit is equipped with a refrigerant leak detection sensor for safety, to be effective, the unit must be electrically powered at all times after installation, other than when servicing. Turning off the circuit breaker cause refrigerant leak detection sensor not to operate and not to enable to detect refrigerant leaks, causing a fire.
- Do not use the refrigerant other than R32 or R410A. For the refrigerant type, check the outdoor unit to be combined.
- The air conditioner must be transported in stable condition. If any part of the product is broken, contact the dealer.
- When the air conditioner must be transported by hand, carry it by four or more people.
- Servicing shall be performed only as recommended by the manufacturer. Do not move or repair any unit by yourself. There is high voltage inside the unit. You may get electric shock when removing the cover and main unit.
- This appliance is intended to be used by expert or trained users in shops, in light industry, or for commercial use by lay persons.

About the refrigerant R32

- The appliance shall be stored in a room without continuously operating ignition sources (for example: open flames, an operating gas appliance or an operating electric heater).
- Do not pierce or burn refrigerant cycle parts.
- Do not use means to accelerate the defrosting process or to clean, other than those recommended by the manufacturer.
- Be aware that refrigerants may not contain an odor.
- Pipe-work shall be protected from physical damage.
- Compliance with national gas regulations shall be observed.
- If refrigerant leak detection sensor detects R32 refrigerant leak, a fan on indoor unit automatically operates to stir an air in the room. Stirring air flow volume of each model is as shown below.

Model name	Stirring air flow (m ³ /h)
RAV-RM561FT*	820
RAV-RM801FT*	930
RAV-RM1101FT*	1,660
RAV-RM1401FT*	1,760
RAV-RM1601FT*	1,760

Selection of installation location

- When the air conditioner is installed in a small room, provide appropriate measures to ensure that the concentration of refrigerant leakage occur in the room does not exceed the critical level.
- Do not install in a location where flammable gas leaks are possible. If the gas leak and accumulate around the unit, it may ignite and cause a fire.
- To transport the air conditioner, wear shoes with additional protective toecap.
- To transport the air conditioner, do not take hold of the bands around the packing carton. You may injure yourself if the bands should break.
- Do not place any combustion appliance in a place where it is directly exposed to the wind of air conditioner, otherwise it may cause imperfect combustion.
- When an outdoor unit using R32 refrigerant is combined with indoor unit, be attention to the floor area in the room to be installed. The unit cannot be installed in the room with floor area less than minimum floor area described in Appendix of this Installation Manual.

Installation

- Install the air conditioner securely in a location where the base can sustain the weight adequately. If the strength is not enough, the unit may fall down resulting in injury.
- Follow the instructions in the Installation Manual to install the air conditioner. Failure to follow these instructions may cause the product to fall down or topple over or give rise to noise, vibration, water leakage or other trouble.
- Carry out the specified installation work to guard against the possibility of high winds and earthquake. If the air conditioner is not installed appropriately, a unit may topple over or fall down, causing an accident.
- If refrigerant gas has leaked during the installation work, ventilate the room immediately. If the leaked refrigerant gas comes in contact with fire, noxious gas may be generated, which may catch a fire.
- Use forklift to carry in the air conditioner units and use winch or hoist at installation of them.
- The installation of pipe work shall be kept to a minimum.

Refrigerant piping

- Install the refrigerant pipe securely during the installation work before operating the air conditioner. If the compressor is operated with the valve open and without refrigerant pipe, the compressor sucks air and the refrigeration cycles is over pressurized, which may cause an injury.
- Tighten the flare nut with a torque wrench in the specified manner. Excessive tighten of the flare nut may cause a crack in the flare nut after a long period, which may result in refrigerant leakage.
- After the installation work, confirm that refrigerant gas does not leak. If refrigerant gas leaks into the room and flows near a fire source, such as a cooking range, noxious gas may be generated, which may catch a fire.
- When the air conditioner has been installed or relocated, follow the instructions in the Installation Manual and purge the air completely so that no gases other than the refrigerant will be mixed in the refrigerating cycle. Failure to purge the air completely may cause the air conditioner to malfunction.
- Nitrogen gas must be used for the airtight test.
- The charge hose must be connected in such a way that it is not slack.

Electrical wiring

- Only a qualified installer (*1) or qualified service person (*1) is allowed to carry out the electrical work of the air conditioner. Under no circumstances must this work be done by an unqualified individual since failure to carry out the work properly may result in electric shocks and/or electrical leaks.
- To connect the electrical wires, repair the electrical parts or undertake other electrical jobs, wear gloves to provide protection for electricians insulating shoes and clothing to provide protection from electric shocks. Failure to wear this protective gear may result in electric shocks.
- Use wiring that meets the specifications in the Installation Manual and the stipulations in the local regulations and laws. Use of wiring which does not meet the specifications may give rise to electric shocks, electrical leakage, smoking and/or a fire.
- Connect earth wire. (Grounding work)
Incomplete earthing causes an electric shock.
- Do not connect earth wires to gas pipes, water pipes, and lightning conductor or telephone earth wires.
- After completing the repair or relocation work, check that the earth wires are connected properly.
- Install a circuit breaker that meets the specifications in the installation manual and the stipulations in the local regulations and laws.
- Install the circuit breaker where it can be easily accessed by the agent.
- When installing the circuit breaker outdoors, install one which is designed to be used outdoors.
- Under no circumstances, the power supply wire or the indoor and outdoor connecting wire must not be connected in the middle (Connection using a solderless terminal etc.)
Connection trouble in the places where the wire is connected in the middle may give rise to smoking and/or a fire.
- Electrical wiring work shall be conducted according to law and regulation in the community and installation manual.
Failure to do so may result in electrocution or short circuit.
- Check that wiring will not be subject to wear, corrosion, excessive pressure, vibration, sharp edges or any other adverse environmental effects. The check shall also take into account the effects of aging or continual vibration from sources such as compressors or fans.

Test run

- Before operating the air conditioner after having completed the work, check that the electrical control box cover of the indoor unit and service panel of the outdoor unit are closed, and set the circuit breaker to the ON position. You may receive an electric shock if the power is turned on without first conducting these checks.
- If there is any kind of trouble (such as check code display has appeared, smell of burning, abnormal sounds, the air conditioner fails to cool or heat or water is leaking) has occurred in the air conditioner, do not touch the air conditioner yourself but set the circuit breaker to the OFF position, and contact a qualified service person. Take steps to ensure that the power will not be turned on (by marking “out of service” near the circuit breaker, for instance) until qualified service person arrives. Continuing to use the air conditioner in the trouble status may cause mechanical problems to escalate or result in electric shocks or other trouble.
- After the work has finished, use an insulation tester set (500 VMΩ) to check the resistance is 1 MΩ or more between the charge section and the non-charge metal section (Earth section). If the resistance value is low, a disaster such as a leak or electric shock is caused at user's side.
- Upon completion of the installation work, check for refrigerant leaks and check the insulation resistance and water drainage. Then conduct a test run to check that the air conditioner is operating properly.

Explanations given to user

- Upon completion of the installation work, tell the user where the circuit breaker is located. If the user does not know where the circuit breaker is, he or she will not be able to turn it off in the event that trouble has occurred in the air conditioner.
- After the installation work, follow the Owner's Manual to explain to the customer how to use and maintain the unit.

Relocation

- Only a qualified installer (*1) or qualified service person (*1) is allowed to relocate the air conditioner. It is dangerous for the air conditioner to be relocated by an unqualified individual since a fire, electric shocks, injury, water leakage, noise and/or vibration may result.

- When carrying out the pump-down work shut down the compressor before disconnecting the refrigerant pipe. Disconnecting the refrigerant pipe with the service valve left open and the compressor still operating will cause air or other gas to be sucked in, raising the pressure inside the refrigeration cycle to an abnormally high level, and possibly resulting in rupture, injury or other trouble.

(*1) Refer to the "Definition of qualified installer or qualified service person".

CAUTION

This Air Conditioner has adopted a refrigerant HFC (R32 or R410A) which does not destroy the ozone layer.

- As the R32 or R410A refrigerant is easily affected by impurities such as moisture, oxidized film, oil, etc., due to the high pressure, be careful not to allow the moisture, dirt, existing refrigerant, refrigerating machine oil, etc., to get mixed up in the refrigeration cycle during the installation work.
 - A special tool for the R32 or R410A refrigerant is required for installation.
 - Use a new and clean piping materials for the connecting pipe so that moisture and dirt are not mixed together during the installation work.
 - When using existing pipes, follow the installation manual enclosed with the outdoor unit.
 - Be careful of fan operation when the circuit breaker is turned on. If the refrigerant leak detection sensor detects the refrigerant leak, a fan automatically rotates even while an air conditioner stops. Be careful not to be injured by the fan.
-

Merci d'avoir acheté ce climatiseur Toshiba.

Lisez attentivement ces instructions comprenant des informations importantes concernant la conformité à la "Directive Matériel" (Directive 2006/42/EC) et assurez-vous de les comprendre.

Après avoir lu ces instructions, veillez à les conserver en lieu sûr avec le Manuel du propriétaire et le Manuel d'installation fournis avec votre produit.

Dénomination générique : Climatiseur

Définition d'un installateur qualifié ou technicien d'entretien qualifié

Le climatiseur doit être installé, entretenu, réparé et enlevé par un installateur qualifié ou une personne d'entretien qualifiée. Lorsqu'une de ces opérations doit être effectuée, demandez à un installateur qualifié ou à un technicien d'entretien qualifié de les exécuter pour vous.

Un installateur qualifié ou technicien d'entretien qualifié est un agent qui a les qualifications et connaissances décrites dans le tableau ci-dessous.

Agent	Qualifications et connaissances que cet agent doit posséder
Installateur qualifié	<ul style="list-style-type: none"> L'installateur qualifié est une personne qui installe, entretient, déplace et enlève les climatiseurs fabriqués par Toshiba Carrier Corporation. Il ou elle a été formé pour installer, entretenir, déplacer et enlever les climatiseurs fabriqués par Toshiba Carrier Corporation ou, alternativement, il ou elle a reçu des consignes concernant de telles opérations par une ou des personnes qui ont été formés et a, par conséquent, acquis toutes les connaissances associées à ces opérations. L'installateur qualifié qui est autorisé à effectuer un travail électrique compris dans l'installation, le déplacement et l'enlèvement possède les qualifications nécessaires à ce travail électrique conformément aux réglementations et à la législation locales, et il ou elle est une personne qui a été formée pour les problèmes relatifs au travail électrique sur les climatiseurs fabriqués par Toshiba Carrier Corporation ou, alternativement, il ou elle a reçu des consignes dans de tels domaines par une ou des personnes qui ont été formées et possèdent, par conséquent, les connaissances relatives à ce travail. L'installateur qualifié qui est autorisé à manipuler du fluide frigorigène et à réaliser un travail de raccordement compris dans l'installation, le déplacement et l'enlèvement possède les qualifications nécessaires à cette manipulation de fluide frigorigène et de ce travail de raccordement conformément aux réglementations et à la législation locales, et il ou elle est une personne qui a été formée pour les problèmes relatifs à la manipulation de fluide frigorigène et de travail de raccordement sur les climatiseurs fabriqués par Toshiba Carrier Corporation ou, alternativement, il ou elle a reçu des consignes dans de tels domaines par une ou des personnes qui ont été formées et possèdent, par conséquent, les connaissances relatives à ce travail. L'installateur qualifié qui est autorisé à travailler en hauteur a été formé aux domaines relatifs au travail en hauteur avec les climatiseurs fabriqués par Toshiba Carrier Corporation ou, alternativement, il ou elle a reçu des consignes dans de tels domaines par une ou des personnes qui ont été formées et possède, par conséquent, toutes les connaissances requises pour ce travail.
Technicien d'entretien qualifié	<ul style="list-style-type: none"> La personne d'entretien qualifiée est une personne qui installe, répare, entretient, déplace et enlève les climatiseurs fabriqués par Toshiba Carrier Corporation. Il ou elle a été formé pour installer, réparer, entretenir, déplacer et enlever les climatiseurs fabriqués par Toshiba Carrier Corporation ou, alternativement, il ou elle a reçu des consignes pour de telles opérations par une ou des personnes qui ont été formées et a, par conséquent, acquis toutes les connaissances associées à ces opérations. La personne d'entretien qualifiée qui est autorisée à effectuer un travail électrique compris dans l'installation, la réparation, le déplacement et l'enlèvement possède les qualifications nécessaires à ce travail électrique conformément aux réglementations et à la législation locales, et il ou elle est une personne qui a été formée pour les problèmes relatifs au travail électrique sur les climatiseurs fabriqués par Toshiba Carrier Corporation ou, alternativement, il ou elle a reçu des consignes dans de tels domaines par une ou des personnes qui ont été formées et possèdent, par conséquent, les connaissances relatives à ce travail. La personne d'entretien qualifiée qui est autorisée à manipuler du fluide frigorigène et à réaliser un travail de raccordement compris dans l'installation, la réparation, le déplacement et l'enlèvement possède les qualifications nécessaires à cette manipulation de fluide frigorigène et de ce travail de raccordement conformément aux réglementations et à la législation locales, et il ou elle est une personne qui a été formée pour les problèmes relatifs à la manipulation de fluide frigorigène et de travail de raccordement sur les climatiseurs fabriqués par Toshiba Carrier Corporation ou, alternativement, il ou elle a reçu des consignes dans de tels domaines par une ou des personnes qui ont été formées et possèdent, par conséquent, les connaissances relatives à ce travail. Le technicien d'entretien qualifié qui est autorisé à travailler en hauteur a été formé aux domaines relatifs au travail en hauteur avec les climatiseurs fabriqués par Toshiba Carrier Corporation ou, alternativement, il ou elle a reçu des consignes dans de tels domaines par une ou des personnes qui ont été formées et possède, par conséquent, toutes les connaissances requises pour ce travail.

Définition de l'équipement de protection

Lorsque le climatiseur doit être transporté, installé, entretenu, réparé ou mis au rebut, portez des gants de protection et des vêtements de 'sécurité'.

En plus de cet équipement de protection normal, portez les protections décrites ci-dessous lorsque vous entreprenez les travaux spéciaux indiqués dans le tableau suivant.

Ne pas porter la tenue de protection adéquate est dangereux car vous serez plus susceptible d'être blessé, brûlé, de subir une décharge électrique ou d'autres blessures.

Travaux entrepris	Équipement de protection porté
Tous types de travaux	Gants de protection Vêtements de sécurité
Travaux liés à l'électricité	Vêtements pour fournir une protection contre les décharges électriques Chaussures isolantes Gants pour fournir une protection contre les chocs électriques
Travail effectué en hauteur (50 cm minimum)	Casques utilisés dans l'industrie
Transport d'objets lourds	Chaussures à bouts renforcés de protection
Réparation de l'unité extérieure	Gants pour fournir une protection contre les chocs électriques

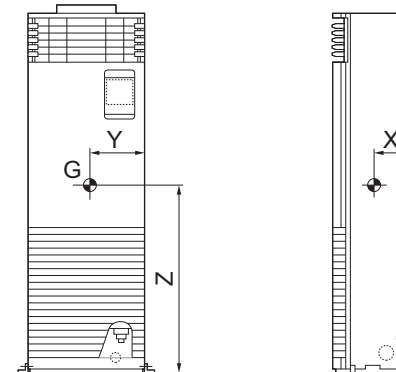

■ Centre de gravité

Modèle	X (mm)	Y (mm)	Z (mm)
RAV-RM561FT-EN/ES	85	285	820
RAV-RM801FT-EN/ES			
RAV-RM1101FT-EN/ES	195	290	860
RAV-RM1401FT-EN/ES			
RAV-RM1601FT-EN/ES			



■ Indications d'avertissement relatives au climatiseur





Ces consignes de sécurité décrivent des sujets importants en matière de sécurité afin de prévenir les blessures des utilisateurs ou d'autres personnes et les dommages matériels. Veuillez lire ce mode d'emploi dans son intégralité après avoir assimilé le contenu ci-dessous (sens des indications) et veillez à suivre la description.



Indication	Sens de l'indication
 AVERTISSEMENT	Le texte introduit de cette manière indique que le non-respect des instructions de l'avertissement peut entraîner des préjudices corporels graves (*1) ou la mort si le produit est manipulé de manière incorrecte.
 ATTENTION	Le texte introduit de cette manière indique que le non-respect des instructions de la précaution peut entraîner des blessures légères (*2) ou des dommages matériels (*3) si le produit est manipulé de manière incorrecte.

*1: Par préjudices corporels graves, on entend : perte de la vue, blessures, brûlures, électrocution, fracture osseuse, empoisonnement et autres lésions laissant des séquelles et nécessitant une hospitalisation ou un traitement ambulatoire de longue durée.

*2: Par blessures légères, on entend : blessures, brûlures, électrocution et autres lésions ne nécessitant pas une hospitalisation ni un traitement ambulatoire de longue durée.

*3: Par dommages matériels, on entend : les dommages touchant les immeubles, les articles ménagers, le bétail domestique et les animaux de compagnie.

	AVERTISSEMENT (Risque d'incendie)	Ce symbole concerne uniquement le réfrigérant R32. Le type de réfrigérant est inscrit sur la plaque signalétique de l'unité extérieure. Si le type de réfrigérant est le R32, cet appareil utilise un réfrigérant inflammable. La fuite ou le contact du réfrigérant avec le feu ou une pièce chauffante produira un gaz nocif, ce qui présente un risque d'incendie.
		Lisez attentivement le MANUEL DU PROPRIÉTAIRE avant utilisation.
		Les techniciens d'entretien sont tenus de lire attentivement le MANUEL DU PROPRIÉTAIRE et le MANUEL D'INSTALLATION avant utilisation.
		Des informations supplémentaires sont disponibles dans le MANUEL DU PROPRIÉTAIRE, le MANUEL D'INSTALLATION et autres.

Indication d'avertissement	Description		
 <table border="1"> <tr> <td>WARNING</td> </tr> <tr> <td>ELECTRICAL SHOCK HAZARD Disconnect all remote electric power supplies before servicing.</td> </tr> </table>	WARNING	ELECTRICAL SHOCK HAZARD Disconnect all remote electric power supplies before servicing.	AVERTISSEMENT RISQUE DE DECHARGE ELECTRIQUE Débranchez toutes les alimentations électriques distantes avant l'entretien.
WARNING			
ELECTRICAL SHOCK HAZARD Disconnect all remote electric power supplies before servicing.			
 <table border="1"> <tr> <td>WARNING</td> </tr> <tr> <td>Moving parts. Do not operate unit with grille removed. Stop the unit before the servicing.</td> </tr> </table>	WARNING	Moving parts. Do not operate unit with grille removed. Stop the unit before the servicing.	AVERTISSEMENT Pièces mobiles. Ne faites pas fonctionner l'unité avec la grille déposée. Arrêtez l'unité avant l'entretien.
WARNING			
Moving parts. Do not operate unit with grille removed. Stop the unit before the servicing.			
 <table border="1"> <tr> <td>CAUTION</td> </tr> <tr> <td>Do not touch the aluminum fins of the unit. Doing so may result in injury.</td> </tr> </table>	CAUTION	Do not touch the aluminum fins of the unit. Doing so may result in injury.	ATTENTION Ne touchez pas les ailettes en aluminium de l'unité. Vous pourriez vous blesser.
CAUTION			
Do not touch the aluminum fins of the unit. Doing so may result in injury.			

1 Précautions relatives à la sécurité

Le fabricant n'assume aucune responsabilité quant aux dommages causés par le non-respect des instructions de ce manuel.

AVERTISSEMENT

Généralités

- Avant d'installer le climatiseur, lisez attentivement le manuel d'installation et suivez les instructions pour installer le climatiseur.
- Seul un installateur qualifié ou un technicien d'entretien qualifié est autorisé à procéder à l'installation. Une installation inadéquate peut entraîner une fuite d'eau, un choc électrique ou un incendie.
- N'utilisez pas un réfrigérant différent de celui spécifié pour le complément ou le remplacement. Sinon, une pression anormalement élevée risque d'être générée dans le circuit de réfrigération, ce qui peut entraîner une panne ou une explosion du produit ou vous pouvez vous blesser.
- Avant d'ouvrir la grille d'entrée d'air de l'unité intérieure ou du panneau de service de l'unité extérieure, réglez le disjoncteur sur la position OFF (ARRÊT). Ne pas régler le disjoncteur sur la position OFF (ARRÊT) peut entraîner un choc électrique par le biais d'un contact avec les pièces intérieures. Seul un installateur qualifié (*1) ou un technicien d'entretien qualifié (*1) est autorisé à enlever la grille d'entrée d'air de l'unité intérieure ou le panneau de service de l'unité extérieure et à effectuer le travail requis.
- Avant de procéder à l'installation, à l'entretien, à la réparation ou à la dépose, réglez le disjoncteur en position OFF (ARRÊT). Dans le cas contraire, cela peut entraîner des chocs électriques.
- Placez un panneau "Travail en cours" à proximité du disjoncteur pendant l'installation, l'entretien, la réparation ou la dépose. Un danger de choc électrique est possible si le disjoncteur est réglé sur ON (MARCHE) par erreur.
- Seul un installateur qualifié (*1) ou un technicien d'entretien qualifié (*1) est autorisé à entreprendre un travail en hauteur à l'aide d'un escabeau de 50 cm ou plus pour retirer la grille d'entrée d'air de l'unité intérieure pour entreprendre le travail.
- Portez des gants de protection ainsi que des vêtements de travail de sécurité pendant l'installation, l'entretien et la dépose.
- Ne touchez pas les palmes en aluminium de l'unité. Vous risquez de vous blesser dans le cas contraire. Si vous devez toucher les palmes pour une raison quelconque, mettez d'abord des gants de protection et des vêtements de travail de sécurité, ensuite, procédez à l'opération.

- Lors de la réalisation d'un travail en hauteur, utilisez une échelle conforme à la norme ISO 14122 et suivez la procédure associée aux instructions de l'échelle. Portez également un casque de protection pour une utilisation dans l'industrie comme tenue de protection pour entreprendre le travail.
- Cet appareil est équipé d'un capteur de détection de fuite de réfrigérant pour des raisons de sécurité. Pour être efficace, l'appareil doit être alimenté électriquement à tout moment après l'installation, sauf lors de l'entretien. L'arrêt du disjoncteur empêche le capteur de détection de fuite de réfrigérant de fonctionner et de détecter les fuites de réfrigérant, provoquant ainsi un incendie.
- N'utilisez pas de réfrigérant autre que le R32 ou R410A. Pour connaître le type de réfrigérant, vérifiez l'unité extérieure à combiner.
- Le climatiseur doit être transporté dans des conditions stables. Si une pièce est endommagée, contactez le revendeur.
- Si le climatiseur doit être transporté à la main, transportez-le à quatre personnes ou plus.
- L'entretien ne doit être effectué que selon les recommandations du fabricant. Ne déplacez ni ne réparez l'unité vous-même. L'intérieur de l'unité est sous haute tension. Vous risqueriez un choc électrique en retirant le couvercle et l'unité principale.
- Cet appareil est conçu pour être utilisé par des experts ou des utilisateurs formés dans des magasins, dans l'industrie légère ou dans le cadre d'une utilisation commerciale par des personnes non initiées.

À propos du réfrigérant R32

- L'appareil doit être rangé dans une pièce sans sources d'inflammation en fonctionnement continu (par exemple : des flammes nues, un appareil à gaz en fonctionnement ou un appareil de chauffage électrique en fonctionnement).
- Ne pas percer ou brûler les pièces du cycle du réfrigérant.
- Ne pas utiliser de moyens pour accélérer le processus de dégivrage ou pour nettoyer, autres que ceux recommandés par le fabricant.
- Sachez que les réfrigérants peuvent ne pas contenir d'odeur.
- La tuyauterie doit être protégée contre les dommages physiques.
- La conformité aux réglementations nationales en matière de gaz doit être observée.
- Si le capteur de détection de fuite de réfrigérant détecte une fuite de réfrigérant R32, un ventilateur de l'unité intérieure fonctionne automatiquement pour générer de l'air dans la pièce. Le volume de flux d'air sous agitation de chaque modèle est indiqué ci-dessous.

Modèle	Débit d'air d'agitation (m ³ /h)
RAV-RM561FT*	820
RAV-RM801FT*	930
RAV-RM1101FT*	1 660
RAV-RM1401FT*	1 760
RAV-RM1601FT*	1 760

Sélection du lieu d'installation

- Si le climatiseur est installé dans une petite pièce, prenez les mesures qui s'imposent pour que, en cas de fuite, la teneur de la pièce en réfrigérant ne dépasse pas le seuil critique.
- N'installez pas cet appareil dans un endroit où des fuites de gaz inflammable sont possibles. En cas de fuite du gaz et d'accumulation à proximité du climatiseur, un incendie peut se déclarer.
- Lors du transport du climatiseur, portez des chaussures à coquilles de protection supplémentaires.
- Lors du transport du climatiseur, n'agrippez pas les bandes du carton d'emballage. Vous risquez de vous blesser si les bandes se brisent.
- Ne placez aucun appareil à combustion dans un endroit exposé directement au souffle du climatiseur, faute de quoi sa combustion risquerait d'être défectueuse.
- Lorsqu'un appareil extérieur utilisant le réfrigérant R32 est combiné avec un appareil intérieur, faites attention à la surface de plancher dans la pièce à installer. L'unité ne peut pas être installée dans une pièce dont la surface au sol est inférieure à la surface minimale décrite dans l'annexe de ce manuel d'installation.

Installation

- Installez le climatiseur en toute sécurité sur une base capable de le supporter. Si la base n'est pas assez résistante, l'unité peut tomber et provoquer des blessures.
- Suivez les instructions du manuel d'installation pour installer le climatiseur. Le non-respect de ces instructions peut entraîner la chute ou le basculement de l'appareil, voire engendrer du bruit, des vibrations, une fuite d'eau, etc.
- Effectuez l'installation spécifiée pour protéger le climatiseur contre un tremblement de terre ou des vents violents. S'il n'est pas correctement monté, le climatiseur risque de tomber ou de basculer, ce qui peut entraîner un accident.
- Si le gaz réfrigérant a fui durant l'installation, aérez immédiatement la pièce. Si le gaz frigorigène qui a fui entre en contact avec le feu, un gaz nocif peut se dégager et de ce fait provoquer un incendie.
- Utilisez un chariot élévateur pour porter le climatiseur. Pour l'élever, utilisez un treuil ou un monte-charge.
- L'installation de la tuyauterie doit être réduite au minimum.

Tuyaux de réfrigérant

- Fixez solidement le tuyau de réfrigérant pendant l'installation, avant de faire fonctionner le climatiseur. Si le compresseur est utilisé avec la vanne ouverte et sans que le tuyau de réfrigérant ne soit connecté, le compresseur aspire l'air et le circuit de réfrigération est alors en surpression. Dans ce cas, les tuyaux risquent de blesser quelqu'un.
- Serrez l'écrou évasé avec une clé dynamométrique de la manière spécifiée. Si vous appliquez un couple excessif, l'écrou risque, après un certain temps, de se casser et de provoquer une fuite de réfrigérant.
- Après l'installation, assurez-vous que le gaz réfrigérant ne fuit pas. Si le gaz réfrigérant fuit dans la pièce et s'écoule à proximité d'une source inflammable, telle qu'une cuisinière, un gaz nocif peut se dégager et de ce fait provoquer un incendie.
- Lorsque le climatiseur a été installé ou déplacé, suivez les instructions du manuel d'installation et purgez la totalité de l'air afin qu'aucun gaz autre que le réfrigérant ne soit mélangé dans le circuit de réfrigération. Ne pas purger complètement l'air peut entraîner un dysfonctionnement du climatiseur.
- De l'azote gazeux doit être utilisé pour l'essai d'étanchéité à l'air.
- Le tuyau de remplissage doit être raccordé de telle manière qu'il ne soit pas lâche.

Raccordement électrique

- Seul un installateur qualifié (*1) ou un technicien d'entretien qualifié (*1) est autorisé à réaliser le travail électrique sur le climatiseur. En aucun cas, ce travail doit être effectué par une personne non qualifiée étant donné que si le travail n'est pas correctement effectué, des chocs électriques et/ou des fuites électriques peuvent survenir.
- Lors du raccordement des câbles électriques, de la réparation des pièces électriques ou de l'exécution d'autres travaux électriques, portez des gants pour vous protéger du courant, ainsi que des chaussures et des vêtements isolants pour vous protéger de chocs électriques. Ne pas porter cette tenue de protection peut entraîner des chocs électriques.
- Utilisez un câblage qui respecte les spécifications du manuel d'installation et les dispositions des réglementations et de la législation locales. L'utilisation d'un câblage qui n'est pas conforme aux spécifications peut donner lieu à des chocs électriques, une fuite électrique, de la fumée et/ou un incendie.
- Branchez le fil de terre. (Mise à la terre)
Une mise à la terre incomplète peut provoquer une décharge électrique.
- Ne raccordez pas les fils de terre à des conduites de gaz, des conduites d'eau, un parafoudre ou des fils de terre pour câbles téléphoniques.
- Après avoir terminé le travail de réparation ou de déplacement, assurez-vous que le fil de terre est correctement raccordé.
- Installez un disjoncteur qui respecte les spécifications du manuel d'installation et les dispositions des réglementations et de la législation locales.
- Installez le disjoncteur là où il peut facilement être accessible par l'agent.
- Lors de l'installation du disjoncteur à l'extérieur, installez-en un qui soit conçu pour être utilisé à l'extérieur.
- En aucun cas le câble d'alimentation électrique ou le câble de connexion intérieur et extérieur ne doivent pas être connectés au milieu (connexion à l'aide d'une borne sans soudure etc.)
Des problèmes de raccordement dans des endroits où le câble est connecté au milieu peuvent entraîner de la fumée et/ou un incendie.
- Le travail de câblage électrique doit être réalisé conformément à la législation et à la réglementation locales et au manuel d'installation. Dans le cas contraire, un choc électrique ou un court-circuit peut survenir.
- Vérifiez que le câblage ne sera pas soumis à l'usure, à la corrosion, à une pression excessive, aux vibrations, aux arêtes vives ou à tout autre effet néfaste sur l'environnement. La vérification doit également prendre en compte les effets du vieillissement ou des vibrations continues provenant de sources telles que les compresseurs ou les ventilateurs.

Essai de fonctionnement

- Avant de faire fonctionner le climatiseur après avoir terminé le travail, assurez-vous que le couvercle du boîtier des pièces électriques de l'unité intérieure et du panneau de service de l'unité extérieure sont fermés, ensuite, réglez le disjoncteur sur la position ON (MARCHE). Vous pouvez recevoir un choc électrique si l'alimentation est activée sans avoir d'abord effectué ces vérifications.
- En cas de problème au niveau du climatiseur (comme par exemple l'affichage d'un code d'erreur, une odeur de brûlé, des sons anormaux, le climatiseur qui ne parvient pas à refroidir ou à réchauffer l'air, ou une fuite d'eau), ne touchez pas le climatiseur vous-même, mais réglez le disjoncteur sur la position OFF (ARRÊT), puis contactez un technicien d'entretien qualifié. Prenez des mesures pour garantir que l'alimentation ne sera pas branchée (en indiquant "hors service" près du disjoncteur, par exemple) jusqu'à ce que le technicien d'entretien qualifié arrive. Continuer à utiliser le climatiseur alors qu'il présente un problème peut entraîner des problèmes mécaniques ou donner lieu à des chocs électriques et autres pannes.
- Une fois le travail terminé, utilisez un contrôleur d'isolement (500 VMΩ) afin de vérifier que la résistance est de 1 MΩ minimum entre la section de charge et la section métallique sans charge (Section terre). Si la valeur de résistance est faible, une catastrophe telle qu'une fuite ou une décharge électrique se produit sur le côté utilisateur.
- À l'issue du travail d'installation, vérifiez qu'il n'y a pas de fuites de réfrigérant et vérifiez la résistance d'isolation ainsi que l'évacuation d'eau. Ensuite, effectuez un essai de fonctionnement afin de vous assurer que le climatiseur fonctionne correctement.

Explications données à l'utilisateur

- À l'issue de l'installation, indiquez à l'utilisateur l'emplacement du disjoncteur. Si l'utilisateur ne sait pas où se trouve le disjoncteur, il ne sera pas capable de le désactiver au cas où un problème surviendrait au niveau du climatiseur.
- Après le travail d'installation, reportez-vous au manuel de l'utilisateur pour expliquer au client comment utiliser l'unité et effectuer son entretien.

Réinstallation

- Seul un installateur qualifié (*1) ou un technicien d'entretien qualifié (*1) est autorisé à déplacer le climatiseur. Le déplacement du climatiseur par une personne non qualifiée représente un danger étant donné qu'un incendie, un choc électrique, des blessures, des fuites d'eau, du bruit et/ou des vibrations peuvent en résulter.

-
- Lors de la réalisation du travail de pompage, coupez le compresseur avant de débrancher le tuyau de réfrigérant. Débrancher le tuyau de réfrigérant alors que la vanne d'entretien est restée ouverte et que le compresseur fonctionne encore peut entraîner une aspiration de l'air ou d'autre gaz, faisant augmenter la pression à l'intérieure du circuit de réfrigération à un niveau anormalement élevé, et pouvant donner lieu à un éclatement, un dommage ou d'autres problèmes.

(*1) Reportez-vous à "Définition d'un installateur qualifié ou d'un technicien d'entretien qualifié".

ATTENTION

Ce climatiseur utilise un frigorigène HFC (R32 ou R410A) qui ne détruit pas la couche d'ozone.

- Le frigorigène R32 ou R410A est facilement affecté par les impuretés telles que l'humidité, un film oxydé, l'huile, etc., en raison d'une pression élevée, c'est pourquoi il faut faire attention de ne pas laisser l'humidité, la poussière, l'huile de la machine frigorifique, le frigorigène existant, etc., se mélanger au cycle de réfrigération pendant les travaux d'installation.
- Un outil spécial pour le frigorigène R32 ou R410A est nécessaire pour l'installation.
- Utilisez un matériau de tuyauterie neuf et propre pour le tuyau de raccordement afin que l'humidité et la saleté ne se mélangent pas pendant les travaux d'installation.
- Lors de l'utilisation de tuyaux existants, suivez les instructions d'installation indiquées dans le manuel d'installation fourni avec l'unité extérieure.
- Faites attention au fonctionnement du ventilateur lorsque le disjoncteur est activé. Si le capteur de détection de fuite de réfrigérant détecte la fuite de réfrigérant, un ventilateur tourne automatiquement même lorsqu'un climatiseur s'arrête. Veillez à ne pas être blessé par le ventilateur.

Vielen Dank, dass Sie sich für ein Klimagerät von Toshiba entschieden haben.
 Lesen Sie bitte diese Anweisungen sowie die wichtigen Informationen zur Einhaltung der „Maschinenrichtlinie“ (Richtlinie 2006/42/EG) sorgfältig durch. Stellen Sie sicher, dass Sie diese Anweisungen verstanden haben.
 Nachdem Sie diese Anweisungen gelesen haben, bewahren Sie sie unbedingt an einem sicheren Ort zusammen mit dem Benutzerhandbuch und dem Ihrem Produkt beiliegenden Installationshandbuch auf.

Allgemeine Bezeichnung: Klimaanlage

Definition der Bezeichnungen „Qualifizierter Installateur“ oder „Qualifizierter Servicetechniker“

Die Klimaanlage muss von einem qualifizierten Installateur oder einem qualifizierten Servicetechniker installiert, gewartet, repariert und entsorgt werden. Wenn eine dieser Aufgaben erledigt werden muss, bitten Sie einen qualifizierten Installateur oder einen qualifizierten Servicetechniker, diese für Sie auszuführen.
 Ein qualifizierter Installateur oder ein qualifizierter Servicetechniker ist ein Auftragnehmer, der über die Qualifikationen und das Fachwissen verfügt, welche in der untenstehenden Tabelle genannt sind.

Auftragnehmer	Qualifikationen und Fachwissen, über welche der Auftragnehmer verfügen muss
Qualifizierter Installateur	<ul style="list-style-type: none"> Der Installationsfachmann ist eine Person, die Klimageräte der Toshiba Carrier Corporation einbaut, wartet, umzieht und ausbaut. Die Person ist im Einbau und in der Wartung sowie im Umzug und Ausbau von Klimageräten der Toshiba Carrier Corporation geschult oder wurde von einer geschulten Person oder geschulten Personen unterwiesen und verfügt aufgrund dessen über gründliche Kenntnisse, die sie zur Ausführung dieser Arbeiten befähigen. Der Installationsfachmann, dem es erlaubt ist, Elektroarbeiten im Zuge des Einbaus, Umzugs oder Ausbaus auszuführen, verfügt über die jeweils gesetzlich vorgeschriebene Qualifikation zur Ausführung von Elektroarbeiten und ist eine Person, die im Zusammenhang mit Elektroarbeiten an Klimageräten der Toshiba Carrier Corporation geschult ist oder in diesem Zusammenhang von einer geschulten Person oder geschulten Personen unterwiesen wurde, so dass sie über gründliche Kenntnisse verfügt, die sie zur Ausführung dieser Arbeiten befähigen. Der Installationsfachmann, dem es erlaubt ist, kältemittel- oder rohrtechnische Arbeiten im Zuge des Einbaus, Umzugs oder Ausbaus auszuführen, verfügt über die jeweils gesetzlich vorgeschriebene Qualifikation zur Ausführung von kältemittel- und rohrtechnischen Arbeiten und ist eine Person, die im Zusammenhang mit kältemittel- und rohrtechnischen Arbeiten an Klimageräten der Toshiba Carrier Corporation geschult ist oder in diesem Zusammenhang von einer geschulten Person oder geschulten Personen unterwiesen wurde, so dass sie über gründliche Kenntnisse verfügt, die sie zur Ausführung dieser Arbeiten befähigen. Der Installationsfachmann, dem es erlaubt ist, Arbeiten in der Höhe auszuführen, ist im Zusammenhang mit Arbeiten in der Höhe an Klimageräten der Toshiba Carrier Corporation geschult oder wurde in diesem Zusammenhang von einer geschulten Person oder geschulten Personen unterwiesen und verfügt aufgrund dessen über gründliche Kenntnisse, die ihn zur Ausführung dieser Arbeiten befähigen.
Qualifizierter Servicetechniker	<ul style="list-style-type: none"> Der Kundendienstfachmann ist eine Person, die Klimageräte der Toshiba Carrier Corporation einbaut, repariert, wartet, umzieht und ausbaut. Die Person ist im Einbau, in der Reparatur und in der Wartung sowie im Umzug und Ausbau von Klimageräten der Toshiba Carrier Corporation geschult oder wurde von einer geschulten Person oder geschulten Personen unterwiesen und verfügt aufgrund dessen über gründliche Kenntnisse, die sie zur Ausführung dieser Arbeiten befähigen. Der Kundendienstfachmann, dem es erlaubt ist, Elektroarbeiten im Zuge des Einbaus, der Reparatur, des Umzugs oder Ausbaus auszuführen, verfügt über die jeweils gesetzlich vorgeschriebene Qualifikation zur Ausführung von Elektroarbeiten und ist eine Person, die im Zusammenhang mit Elektroarbeiten an Klimageräten der Toshiba Carrier Corporation geschult ist oder in diesem Zusammenhang von einer geschulten Person oder geschulten Personen unterwiesen wurde, so dass sie über gründliche Kenntnisse verfügt, die sie zur Ausführung dieser Arbeiten befähigen. Der Kundendienstfachmann, dem es erlaubt ist, kältemittel- oder rohrtechnische Arbeiten im Zuge des Einbaus, der Reparatur, des Umzugs oder Ausbaus auszuführen, verfügt über die jeweils gesetzlich vorgeschriebene Qualifikation zur Ausführung von kältemittel- und rohrtechnischen Arbeiten und ist eine Person, die im Zusammenhang mit kältemittel- und rohrtechnischen Arbeiten an Klimageräten der Toshiba Carrier Corporation geschult ist oder in diesem Zusammenhang von einer geschulten Person oder geschulten Personen unterwiesen wurde, so dass sie über gründliche Kenntnisse verfügt, die sie zur Ausführung dieser Arbeiten befähigen. Der Kundendienstfachmann, dem es erlaubt ist, Arbeiten in der Höhe auszuführen, ist im Zusammenhang mit Arbeiten in der Höhe an Klimageräten der Toshiba Carrier Corporation geschult oder wurde in diesem Zusammenhang von einer geschulten Person oder geschulten Personen unterwiesen und verfügt aufgrund dessen über gründliche Kenntnisse, die ihn zur Ausführung dieser Arbeiten befähigen.

Definitionen zur Schutzkleidung

Wenn die Klimaanlage transportiert, installiert, gewartet, repariert oder entsorgt werden soll, tragen Sie Schutzhandschuhe und Arbeitsschutzbekleidung.
 Tragen Sie zusätzlich zu dieser normalen Schutzkleidung die unten aufgeführte Schutzkleidung, wenn Sie die in der unteren Tabelle genannten Spezialarbeiten ausführen.
 Wenn Sie nicht die geeignete Schutzkleidung tragen, setzen Sie sich erhöhten Gefahren aus, da Sie sich eher Verletzungen, Verbrennungen, Stromschläge u. a. zuziehen.

Arbeitsaufgabe	Zu tragende Schutzkleidung
Alle Arten von Arbeiten	Schutzhandschuhe Arbeitsschutzbekleidung
Elektroarbeiten	Kleidung zum Schutz vor Stromschlägen Isolierendes Schuhwerk Handschuhe zum Schutz vor Stromschlag
Arbeiten in der Höhe (50 cm und höher)	Industrie-Schutzhelme
Transport schwerer Gegenstände	Schuhe mit zusätzlichen Zehenschutzkappen
Reparatur des Außengeräts	Handschuhe zum Schutz vor Stromschlag

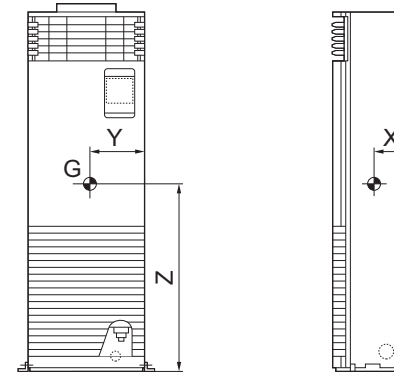

■ Schwerpunkt

Modellbezeichnung	X (mm)	Y (mm)	Z (mm)
RAV-RM561FT-EN/ES	85	285	820
RAV-RM801FT-EN/ES			
RAV-RM1101FT-EN/ES	195	290	860
RAV-RM1401FT-EN/ES			
RAV-RM1601FT-EN/ES			



■ Warnhinweise an der Klimaanlage





Diese Sicherheitshinweise beschreiben wichtige Sicherheitsaspekte, um Verletzungen bei Benutzern oder anderen Personen sowie Sachschäden zu vermeiden. Bitte lesen Sie diese Anleitung sorgfältig durch, nachdem Sie die folgenden Inhalte (Bedeutung der Hinweise) verstanden haben, und befolgen Sie unbedingt die Beschreibung.



Hinweis	Bedeutung der Hinweise
 WARNUNG	Ein auf diese Weise gekennzeichnete Text weist darauf hin, dass die Nichtbeachtung der Warnhinweise bei unsachgemäßer Handhabung zu schweren Körperverletzungen (*1) oder zum Verlust von Menschenleben führen kann.
 VORSICHT	Ein auf diese Weise gekennzeichnete Text weist darauf hin, dass die Nichtbeachtung der Vorsichtshinweise bei der unsachgemäßen Handhabung des Produkts zu leichten Verletzungen (*2) oder Sachschäden (*3) führen kann.

*1: „Schwere Körperverletzungen“ umfassen den Verlust der Sehkraft, Verletzungen, Verbrennungen, Stromschläge, Knochenbrüche, Vergiftungen oder andere Verletzungen, die eine Folgeerscheinung hinterlassen und einen Krankenhausaufenthalt oder eine langfristige ambulante Behandlung erfordern.

*2: „Leichte Verletzungen“ umfassen Verletzungen, Verbrennungen, Stromschläge und andere Verletzungen, die keinen Krankenhausaufenthalt bzw. keine langfristige ambulante Behandlung erfordern.

*3: „Sachschäden“ umfassen Schäden an Gebäuden, Hausrat, Nutztieren und Haustieren.

	WARNUNG (Brandgefahr)	Diese Kennzeichnung gilt nur für das Kältemittel R32. Der Kältemitteltyp ist auf dem Typenschild des Außengerätes angegeben. Wenn der Kältemitteltyp R32 ist, wird in diesem Gerät ein brennbares Kältemittel eingesetzt. Wenn Kältemittel austritt und mit Feuer oder Heizungskomponenten in Berührung kommt, entsteht ein gefährliches Gas, und es besteht Brandgefahr.
		Lesen Sie vor der Inbetriebnahme das BENUTZERHANDBUCH sorgfältig durch.
		Das Servicepersonal muss vor der Inbetriebnahme sowohl das BENUTZERHANDBUCH als auch das INSTALLATIONSHANDBUCH sorgfältig durchlesen.
		Weitere Informationen finden Sie im BENUTZERHANDBUCH, INSTALLATIONSHANDBUCH und in anderen Quellen.

Warnanzeige	Beschreibung		
 <table border="1"> <tr> <td>WARNING</td> </tr> <tr> <td>ELECTRICAL SHOCK HAZARD Disconnect all remote electric power supplies before servicing.</td> </tr> </table>	WARNING	ELECTRICAL SHOCK HAZARD Disconnect all remote electric power supplies before servicing.	WARNUNG GEFAHR EINES STROMSCHLAGS Trennen Sie alle fernen Stromversorgungsquellen vom Netz, bevor Sie Wartungsarbeiten ausführen.
WARNING			
ELECTRICAL SHOCK HAZARD Disconnect all remote electric power supplies before servicing.			
 <table border="1"> <tr> <td>WARNING</td> </tr> <tr> <td>Moving parts. Do not operate unit with grille removed. Stop the unit before the servicing.</td> </tr> </table>	WARNING	Moving parts. Do not operate unit with grille removed. Stop the unit before the servicing.	WARNUNG Bewegliche Teile. Bedienen Sie nicht das Gerät, wenn das Gitter entfernt wurde. Stoppen Sie das Gerät, bevor Sie es warten.
WARNING			
Moving parts. Do not operate unit with grille removed. Stop the unit before the servicing.			
 <table border="1"> <tr> <td>CAUTION</td> </tr> <tr> <td>Do not touch the aluminum fins of the unit. Doing so may result in injury.</td> </tr> </table>	CAUTION	Do not touch the aluminum fins of the unit. Doing so may result in injury.	VORSICHT Berühren Sie nicht die Aluminiumlamellen des Geräts. Dies kann zu Verletzungen führen.
CAUTION			
Do not touch the aluminum fins of the unit. Doing so may result in injury.			

1 Vorsichtsmaßnahmen für die Sicherheit

Der Hersteller übernimmt keinerlei Haftung für durch Nichtbeachtung der Beschreibungen in diesem Handbuch entstandene Schäden.

WARNUNG

Allgemeines

- Bevor Sie mit der Installation des Klimageräts beginnen, lesen Sie das Installationshandbuch sorgfältig durch und befolgen Sie die darin enthaltenen Anweisungen zum Installieren des Klimageräts.
- Die Installationsarbeiten dürfen nur von qualifiziertem Installations- oder Servicepersonal durchgeführt werden. Eine nicht fachgerechte Installation kann zum Austritt von Wasser sowie zu Stromschlägen oder Brand führen.
- Verwenden Sie ausschließlich das zur Ergänzung oder als Ersatz angegebene Kühlmittel. Andernfalls kann im Kühlkreislauf ein abnormal hoher Druck entstehen, der eine Fehlfunktion oder Explosion des Produkts oder Verletzungen zur Folge haben kann.
- Bevor Sie das Einlassgitter des Innengerätes oder das Wartungspaneel des Außengeräts öffnen, stellen Sie den Schutzschalter auf die Position OFF (aus). Sollten Sie diesen Hinweis nicht beachten, kann es durch Kontakt mit den Innenteilen zu einem Stromschlag kommen. Nur ein qualifizierter Installateur (*1) oder ein qualifizierter Servicetechniker (*1) darf das Einlassgitter des Innengeräts oder das Wartungspaneel des Außengeräts entfernen und die erforderlichen Arbeiten ausführen.
- Bevor Sie mit den Installations-, Wartungs-, Reparatur- oder Deinstallationsarbeiten beginnen, schalten Sie den Hauptschalter in die Stellung OFF (aus). Anderenfalls kann es zu elektrischen Schlägen kommen.
- Befestigen Sie ein Schild „Arbeiten in Ausführung“ neben dem Schutzschalter, während die Installations-, Wartungs-, Reparatur- oder Entsorgungsarbeiten ausgeführt werden. Es besteht die Gefahr von Stromschlägen, wenn der Schutzschalter aus Versehen auf ON (ein) gestellt wird.
- Nur ein qualifizierter Installateur (*1) oder ein qualifizierter Servicetechniker (*1) darf Höhenarbeiten unter Verwendung eines 50 cm hohen oder noch höheren Ständers ausführen oder das Einlassgitter des Innengeräts entfernen und die erforderlichen Arbeiten ausführen.
- Tragen Sie bei Installation, Wartung und Entsorgung Schutzhandschuhe und Arbeitsschutzbekleidung.
- Die Aluminiumlamelle des Geräts nicht berühren. Anderenfalls können Sie sich verletzen. Wenn die Rippen aus einem bestimmten Grund berührt werden muss, ziehen Sie zuerst Schutzhandschuhe und Arbeitsschutzbekleidung an, bevor Sie diese Arbeiten ausführen.

- Wenn Sie Höhenarbeiten ausführen, verwenden Sie eine Leiter gemäß ISO-Norm 14122 und befolgen Sie die in der Anleitung der Leiter aufgeführten Anweisungen. Tragen Sie als Schutzkleidung beim Ausführen der Arbeiten außerdem einen Industrie-Schutzhelm.
- Dieses Gerät ist aus Sicherheitsgründen mit einem Kältemittelleck-Erkennungssensor ausgestattet, damit dieser funktioniert, muss das Gerät nach der Installation stets mit Strom versorgt sein, es sei denn, es wird gewartet. Wenn Sie den Schutzschalter ausschalten, führt dies dazu, dass der Kältemittelleck-Erkennungssensor nicht funktioniert und nicht in der Lage ist, Kältemittellecks zu erkennen, was zu einem Feuer führt.
- Verwenden Sie kein anderes Kältemittel als R32 oder R410A. Überprüfen Sie das zu kombinierende Außengerät wegen des Kältemitteltyps.
- Die Klimaanlage muss in einem stabilen Zustand transportiert werden. Setzen Sie sich mit Ihrem Fachhändler in Verbindung, falls Sie feststellen sollten, dass ein Teil des Produkts defekt ist.
- Falls die Klimaanlage von Hand transportiert wird, muss diese von mindestens vier Personen getragen werden.
- Die Wartung darf nur gemäß den Empfehlungen des Herstellers durchgeführt werden. Im Geräteinneren liegt Hochspannung an. Beim Ausbau von Abdeckung und Hauptgerät besteht elektrische Berührungsgefahr.
- Dieses Gerät ist für die Nutzung durch einem Experten oder geschulte Anwender in Geschäften, in der leichten Industrie oder für Laien bei der gewerblichen Nutzung bestimmt.

Über das Kältemittel R32

- Das Gerät muss in einem Raum ohne kontinuierlich arbeitende Zündquellen gelagert werden (zum Beispiel: offenes Feuer, ein Gasgerät in Betrieb oder eine elektrische Heizung in Betrieb).
- Die Teile des Kältemittelkreislaufs nicht durchbohren oder verbrennen.
- Verwenden Sie keine anderen als die vom Hersteller empfohlenen Mittel, um den Abtauvorgang zu beschleunigen, oder zur Reinigung.
- Beachten Sie, dass Kältemittel möglicherweise geruchlos sind.
- Rohrleitungen sind vor physischen Beschädigungen zu schützen.
- Die Einhaltung der nationalen Vorschriften für Gas ist zu beachten.
- Wenn der Erkennungssensor für Kältemittellecks einen Austritt des Kältemittels R32 erkennt, wird automatisch ein Lüfter am Innengerät in Betrieb gesetzt, um die Luft im Raum umzuwälzen. Das Umwälzluftvolumen für die einzelnen Modelle wird unten angegeben.

Modellbezeichnung	Umwälzluftvolumen (m ³ /h)
RAV-RM561FT*	820
RAV-RM801FT*	930
RAV-RM1101FT*	1 660
RAV-RM1401FT*	1 760
RAV-RM1601FT*	1 760

Auswahl des Installationsortes

- Wenn Sie die Klimaanlage in einem kleinen Raum installieren, treffen Sie entsprechende Vorkehrungen, damit es in dem Raum bei einem Leck nicht zu einer übermäßigen Konzentration von Kühlmitteldämpfen kommt.
- Nehmen Sie keine Installation an einem Ort vor, an dem der Austritt entflammbarer Gase möglich sein könnte. Wenn entflammbares Gas austritt und sich um das Gerät herum ansammelt, könnte es sich entzünden und einen Brand verursachen.
- Tragen Sie beim Transportieren der Klimaanlage Schuhe mit Zehenschutzkappe.
- Halten Sie die Klimaanlage beim Tragen nicht an den Bändern des Verpackungskartons fest. Anderenfalls können Sie sich verletzen, wenn die Bänder reißen.
- Stellen Sie keine Verbrennungsvorrichtung an Orten auf, wo sie direkt dem Wind der Klimaanlage ausgesetzt ist, da anderenfalls eine unvollständige Verbrennung die Folge ist.

- Wenn Sie ein Außengerät, in dem das Kältemittel R32 eingesetzt wird, mit einem Innengerät kombinieren, achten Sie auf die Grundfläche des Raumes, in dem es aufgestellt wird. Das Gerät darf nicht in einem Raum aufgestellt werden, der eine geringere Grundfläche als die im Anhang dieses Installationshandbuchs beschriebene Mindestgrundfläche hat.

Installation

- Installieren Sie die Klimaanlage sicher an einer Stelle, die für das Gewicht des Geräts geeignet ist. Ist der Boden nicht widerstandsfähig genug, kann das Gerät umkippen und Verletzungen verursachen.
- Installieren Sie die Klimaanlage entsprechend den Anweisungen im Installationshandbuch. Bei Missachtung dieser Anweisungen kann das Gerät hinunterfallen, umkippen oder Geräusche, Vibrationen, Wasseraustritte oder andere Probleme verursachen.
- Falls Sie in einem windanfälligen oder erdbebengefährdeten Gebiet leben, achten Sie bei der Installation auf eine entsprechende Auslegung der Befestigung. Wenn die Klimaanlage nicht ordnungsgemäß installiert wird, kann das Gerät umkippen oder hinunterfallen und so einen Unfall verursachen.
- Ist während der Installation Kühlmittel ausgetreten, lüften Sie den Raum umgehend. Wenn ausgetretenes, gasförmiges Kältemittel in Kontakt mit einer offenen Flamme kommt, können giftige Gase entstehen, die in Brand geraten können.
- Verwenden Sie für den Transport der Klimaanlage einen Gabelstapler sowie eine Winde oder einen Flaschenzug bei der Installation.
- Die Installation von Rohrleitungen ist auf ein Minimum zu beschränken.

Kühlmittelleitungen

- Überprüfen Sie die sichere Installation der Kühlmittelleitung, bevor Sie die Klimaanlage in Betrieb nehmen. Falls der Kompressor bei geöffnetem Ventil und ohne Kühlmittelrohr betrieben wird, saugt er Luft ein und der Gasdruck im Kühlkreislauf wird extrem hoch, was zu einer Verletzung führen kann.
- Ziehen Sie die Bördelmutter mit einem Drehmomentschlüssel wie angegeben fest. Übermäßiges Festziehen der Bördelmutter kann nach längerer Zeit zu Rissen in der Bördelmutter führen, wodurch Kühlmittel auslaufen kann.
- Vergewissern Sie sich daher nach der Installation noch einmal, dass kein Kühlmittel austreten kann. Wenn gasförmiges Kältemittel in den Raum austritt und in die Nähe einer Brandquelle gelangt, wie z. B. eines Herds oder Ofens, kann sich giftiges Gas bilden, das in Brand geraten kann.

- Wenn die Klimaanlage installiert oder umgesetzt wurde, führen Sie gemäß den Anweisungen im Installationshandbuch eine vollständige Luftspülung aus, so dass lediglich das Kühlmittel im Kühlkreislauf gemischt wird. Wird keine vollständige Luftspülung ausgeführt, können Fehlfunktionen der Klimaanlage auftreten.
- Für die Luftdichteprüfung muss Stickstoff verwendet werden.
- Der Zuleitungsschlauch muss so angeschlossen werden, dass er nicht durchhängt.

Elektrische Verdrahtung

- Nur ein qualifizierter Installateur (*1) oder ein qualifizierter Servicetechniker (*1) darf Elektroarbeiten an der Klimaanlage ausführen. Unter keinen Umständen dürfen diese Arbeiten von unqualifizierten Mitarbeitern ausgeführt werden, da eine nicht sachgemäße Ausführung der Arbeit zu elektrischen Schlägen und/oder Kriechströmen führen kann.
- Tragen Sie beim Anschließen von elektrischen Drähten, Reparieren von elektrischen Teilen oder Ausführen anderer Elektroarbeiten Isolierhandschuhe zum Schutz vor Stromschlägen, isolierendes Schuhwerk sowie Arbeitsschutzkleidung zum Schutz vor Stromschlägen. Falls keine Schutzkleidung getragen wird, kann es zu elektrischen Schlägen kommen.
- Beachten Sie beim Legen von elektrischen Leitungen die Spezifikationen im Installationshandbuch sowie die Bestimmungen der lokalen Gesetze und die Rechtsvorschriften. Bei Verwendung von Kabeln, die die Spezifikationen nicht erfüllen, kann es zu Stromschlägen, Kriechströmen, Rauchentwicklungen und/oder Bränden kommen.
- Schließen Sie das Erdungskabel an. (Erdungsarbeiten)
Eine ungenügende Erdung kann einen Stromschlag verursachen.
- Schließen Sie die Erdungskabel nie an Gas- oder Wasserleitungen, Blitzableiter oder Erdungskabel von Telefonkabeln an.
- Prüfen Sie nach Abschluss der Reparatur- oder Umsetzungsarbeiten, ob die Erdungsleiter korrekt angeschlossen sind.
- Installieren Sie einen Schutzschalter, der die Spezifikationen im Installationshandbuch sowie die Bestimmungen der lokalen Gesetze und die Rechtsvorschriften erfüllt.
- Bringen Sie den Schutzschalter an einem Ort an, wo er vom Bediener problemlos erreicht werden kann.
- Wenn der Schutzschalter im Freien installiert werden soll, verwenden Sie einen Outdoor-Schutzschalter.
- Unter keinen Umständen darf die Stromleitung oder die Anschlussleitung des Innengeräts und Außengeräts in der Mitte angeschlossen werden (Anschluss an einem lötfreien Anschluss usw.)
Ein Anschlussfehler, der dadurch entsteht, dass die Leitung in der Mitte angeschlossen wurde, kann zu Rauchbildung und/oder einem Brand führen.

- Alle elektrischen Arbeiten sind nach geltender Vorschrift und unter Beachtung des Installationshandbuchs auszuführen.
Es besteht Stromschlag- und Kurzschlussgefahr.
- Sorgen Sie dafür, dass die Kabel nicht Verschleiß, Korrosion, übermäßigen Druck, Vibrationen, scharfen Kanten oder anderen schädlichen Umwelteinflüssen ausgesetzt werden. Bei der Prüfung sind auch die Auswirkungen der Alterung und ständiger Vibrationen z. B. durch Kompressoren oder Lüfter zu berücksichtigen.

Testlauf

- Bevor Sie die Klimaanlage nach Abschluss der Arbeiten betreiben, stellen Sie sicher, dass die Abdeckung des Stromkastens am Innengerät und das Wartungspaneel des Außengeräts geschlossen sind, und stellen Sie den Schutzschalter auf die Position ON (ein). Sie können einen elektrischen Schlag erleiden, falls der Strom eingeschaltet wird, ohne dass Sie vorher diese Prüfungen durchgeführt haben.
- Falls Probleme mit der Klimaanlage auftreten (z. B. ein Fehler wird angezeigt, es riecht verbrannt, ungewöhnliche Geräusche sind zu hören, die Klimaanlage kühlt bzw. heizt nicht oder Wasser läuft aus), suchen Sie nicht selbst nach der Ursache, sondern stellen Sie den Schutzschalter auf die Position OFF (aus) und wenden Sie sich an einen Servicetechniker. Stellen Sie sicher, dass der Strom nicht wieder eingeschaltet wird (indem Sie beispielsweise den Schutzschalter durch „außer Betrieb“ kennzeichnen), bis ein qualifizierter Servicetechniker eintrifft. Die weitere Verwendung der Klimaanlage in fehlerhaftem Zustand kann zur Verschlimmerung der mechanischen Probleme oder zu elektrischen Schlägen und anderen Problemen führen.
- Nachdem die Arbeiten abgeschlossen wurden, überprüfen Sie mit einem Isolationsprüfgerät (500 VM Ω), dass der Widerstand zwischen dem geladenen Teil und dem nichtgeladenen Metallteil (Erdungsbereich) 1 M Ω oder mehr beträgt. Falls der Widerstandswert zu niedrig ist, können an der Benutzerseite Kriechströme oder Stromschläge verursacht werden.
- Stellen Sie nach Abschluss der Installationsarbeiten sicher, dass kein Kühlmittel ausläuft, und prüfen Sie Isolierwiderstand sowie Wasserableitung. Führen Sie danach einen Testlauf durch, um sicherzustellen, dass die Klimaanlage ordnungsgemäß funktioniert.

Dem Benutzer mitzuteilende Informationen

- Teilen Sie dem Benutzer nach Abschluss der Installationsarbeiten mit, wo sich der Schutzschalter befindet. Sollte der Benutzer nicht wissen, wo sich der Schutzschalter befindet, kann er diesen nicht ausschalten, falls Probleme mit der Klimaanlage auftreten.

-
- Befolgen Sie nach den Installationsarbeiten die Bedienungsanleitung, um dem Kunden zu erklären, wie das Gerät verwendet und gewartet wird.

Umsetzung

- Nur ein qualifizierter Installateur (*1) oder ein qualifizierter Servicetechniker (*1) darf die Klimaanlage umsetzen. Es ist gefährlich, wenn die Klimaanlage durch einen nicht qualifizierten Benutzer umgesetzt wird, da es zu Bränden, elektrischen Schlägen, Verletzungen, Wasseraustritten, Geräuschen und/oder Vibrationen kommen kann.
- Schließen Sie beim Durchführen der Abpumparbeiten zuerst den Kompressor, bevor Sie das Kühlmittelrohr trennen. Wenn die Kältemittelleitung bei offenem Wartungsventil abgetrennt wird und der Kompressor noch läuft, werden Luft oder andere Gase angesaugt. Der Druck im Kältemittelkreislauf steigt, und es besteht die Gefahr eines Leitungsbruchs und dementsprechend die Gefahr von Verletzungen und anderen Störungen.

(*1) Siehe „Definition der Bezeichnungen „Qualifizierter Installateur“ oder „Qualifizierter Servicetechniker“.

VORSICHT

Diese Klimaanlage verwendet ein HFC-Kältemittel (R32 oder R410A), das die Ozonschicht nicht angreift.

- Da das R32- oder R410A-Kältemittel aufgrund des hohen Drucks leicht durch Verunreinigungen wie zum Beispiel Feuchtigkeit, einer Oxidationsschicht, Öl usw. in Mitleidenschaft gezogen wird, achten Sie sorgfältig darauf, dass bei den Installationsarbeiten keine Feuchtigkeit, kein Schmutz, verbrauchtes Kältemittel, Kältemaschinenöl usw. in den Kältemittelkreislauf eindringt.
- Für die Installation des Kältemittels R32 oder R410A ist ein Spezialwerkzeug erforderlich.
- Verwenden Sie für das Anschließen der Rohre neue und saubere Leitungen, sodass das Kältemittel während der Installationsarbeiten nicht mit Wasser und Schmutz verunreinigt wird.
- Wenn Sie die vorhandenen Leitungen verwenden, befolgen Sie die dem Außengerät beigefügte Installationsanleitung.
- Achten Sie auf den Lüfterbetrieb, wenn der Schutzschalter eingeschaltet ist. Wenn der Kältemittelleck-Erkennungssensor ein Kältemittelleck erkennt, setzt sich der Lüfter automatisch in Bewegung, auch wenn die Klimaanlage sich ausschaltet. Achten Sie darauf, dass Sie sich nicht am Lüfter verletzen.

Grazie per aver acquistato questo condizionatore d'aria Toshiba.

Leggere attentamente queste istruzioni, che contengono informazioni importanti di conformità con la "Direttiva Macchine" (Direttiva 2006/42/CE), e assicurarsi di averle comprese.

Al termine della lettura delle presenti istruzioni, assicurarsi di conservarle in un luogo sicuro, insieme al Manuale del proprietario e al Manuale di installazione in dotazione con il prodotto.

Denominazione generica: Condizionatore d'aria

Definizione di installatore qualificato o tecnico dell'assistenza qualificato

Il condizionatore d'aria deve essere installato, sottoposto a manutenzione, riparato e rimosso da un installatore qualificato o da un tecnico dell'assistenza qualificato. Quando deve essere eseguito uno di questi lavori, rivolgersi a un installatore qualificato o a un tecnico dell'assistenza qualificato per svolgerli in propria vece.

Un installatore qualificato o un tecnico dell'assistenza qualificato è un agente che dispone delle qualifiche e dell'esperienza descritti nella tabella seguente.

Agente	Qualifiche ed esperienza di cui deve disporre l'agente
Installatore qualificato	<ul style="list-style-type: none"> L'installatore qualificato è una persona che installa, effettua la manutenzione, sposta e rimuove i condizionatori d'aria costruiti da Toshiba Carrier Corporation. Questa persona è stata addestrata a installare, sottoporre a manutenzione, trasferire e rimuovere i condizionatori d'aria prodotti da Toshiba Carrier Corporation o, in alternativa, ha ricevuto istruzioni relative a tali operazioni da parte di uno o più individui che sono stati addestrati e, pertanto, ha piena dimestichezza con le nozioni relative a tali operazioni. L'installatore qualificato che è autorizzato a svolgere i lavori sull'impianto elettrico implicati nell'installazione, nel trasferimento e nella rimozione, dispone delle qualifiche relative a tali lavori sull'impianto elettrico, definite dalle leggi e dalle normative locali, e tale persona è stata addestrata relativamente agli argomenti pertinenti ai lavori sugli impianti elettrici per i condizionatori d'aria prodotti da Toshiba Carrier Corporation, o, in alternativa, ha ricevuto istruzioni relative a tali argomenti da parte di uno o più individui che sono stati addestrati e, pertanto, ha piena dimestichezza con le nozioni relative a tali lavori. L'installatore qualificato che è autorizzato a occuparsi della gestione del refrigerante e dei lavori sulle tubature implicati nell'installazione, nel trasferimento e nella rimozione, dispone delle qualifiche relative a tale gestione del refrigerante e a tali lavori sulle tubature, definite dalle leggi e dalle normative locali, e tale persona è stata addestrata relativamente agli argomenti pertinenti alla gestione del refrigerante e ai lavori sulle tubature per i condizionatori d'aria prodotti da Toshiba Carrier Corporation o, in alternativa, ha ricevuto istruzioni relative a tali argomenti da parte di uno o più individui che sono stati addestrati e, pertanto, ha piena dimestichezza con le nozioni relative a tali lavori. L'installatore qualificato autorizzato a svolgere lavori in altezza ha ricevuto la formazione necessaria per effettuare tali lavori con i condizionatori d'aria costruiti da Toshiba Carrier Corporation o, in alternativa, è stato addestrato da uno o più individui in possesso della necessaria formazione, ed è pertanto idoneo a svolgere tali operazioni.
Tecnico dell'assistenza qualificato	<ul style="list-style-type: none"> Il personale di assistenza qualificato è una persona che installa, ripara, effettua la manutenzione, sposta e rimuove i condizionatori d'aria costruiti da Toshiba Carrier Corporation. Ha ricevuto la formazione necessaria per installare, riparare, mantenere, spostare e rimuovere i condizionatori d'aria costruiti da Toshiba Carrier Corporation o, in alternativa, è stato addestrato da uno o più individui in possesso della necessaria formazione, ed è pertanto idoneo a svolgere tali operazioni. Il tecnico di assistenza qualificato autorizzato a eseguire i lavori elettrici richiesti per l'installazione, la riparazione e la rimozione dei condizionatori, possiede le qualifiche necessarie per svolgere tali compiti come richiesto dalle leggi e dai regolamenti locali; egli ha ricevuto la formazione necessaria per eseguire lavori elettrici sui condizionatori d'aria Toshiba Carrier Corporation o, in alternativa, è stato addestrato da uno o più individui a loro volta addestrati e quindi in possesso delle necessarie conoscenze per svolgere tali lavori. Il tecnico di assistenza qualificato autorizzato a eseguire i lavori di carico del refrigerante e la posa dei relativi tubi durante l'installazione, la riparazione e/o la rimozione dei condizionatori, possiede le qualifiche necessarie per svolgere tali lavori come richiesto dalle leggi e dai regolamenti locali; egli ha ricevuto la necessaria formazione per eseguire questi tipi di lavoro sui condizionatori d'aria Toshiba Carrier Corporation o, alternativamente, è stato addestrato da uno o più individui a loro volta addestrati e quindi in possesso delle necessarie conoscenze per svolgere tali lavori. Il personale di assistenza qualificato che è autorizzato a lavorare in altezza è stato addestrato relativamente agli argomenti pertinenti al lavoro in altezza con i condizionatori d'aria prodotti da Toshiba Carrier Corporation o, in alternativa, ha ricevuto istruzioni relative a tali argomenti da parte di uno o più individui che sono stati addestrati e, pertanto, ha piena dimestichezza con le nozioni relative a tali lavori.

Definizione di attrezzatura protettiva

Quando è necessario trasportare, installare, sottoporre a manutenzione, riparare o rimuovere il condizionatore d'aria, indossare guanti di protezione e indumenti da lavoro di sicurezza.

Oltre alla normale attrezzatura protettiva, indossare l'attrezzatura protettiva descritta di seguito quando si intraprendono i lavori speciali descritti in dettaglio nella tabella seguente.

Qualora non si indossi l'attrezzatura protettiva appropriata, si corre un pericolo, in quanto si sarà più suscettibili a lesioni personali, ustioni, scosse elettriche e altri infortuni.

Lavoro intrapreso	Attrezzatura protettiva indossata
Tutti i tipi di lavori	Guanti protettivi Indumenti da lavoro di sicurezza
Lavoro su impianti elettrici	Indumenti per fornire protezione da scosse elettriche Calzature isolanti Guanti di protezione da scosse elettriche
Lavori in altezza (50 cm o più)	Elmetti per uso industriale
Trasporto di oggetti pesanti	Scarpe con calotte protettive aggiuntive per le dita
Riparazione dell'unità esterna	Guanti di protezione da scosse elettriche

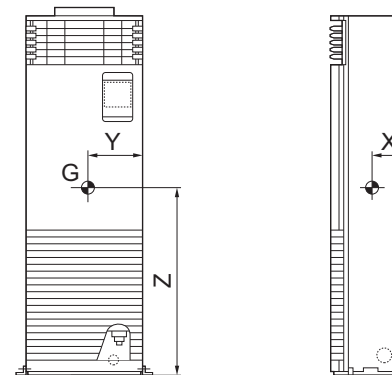

■ Centro di gravità

Modelli	X (mm)	Y (mm)	Z (mm)
RAV-RM561FT-EN/IT	85	285	820
RAV-RM801FT-EN/IT			
RAV-RM1101FT-EN/IT	195	290	860
RAV-RM1401FT-EN/IT			
RAV-RM1601FT-EN/IT			



■ Indicazioni di avvertimento sul condizionatore d'aria





Le presenti istruzioni di sicurezza descrivono argomenti importanti relativi alla sicurezza per evitare lesioni personali agli utenti e ad altre persone, nonché danni alle cose. Leggere a fondo il presente manuale dopo averne compreso i contenuti seguenti (significati delle indicazioni), e accertarsi di attenersi alla descrizione.



Indicazione	Significato dell'indicazione
 AVVERTIMENTO	Il testo evidenziato in questo modo indica che la mancata conformità alle indicazioni nell'avvertenza in questione potrebbe causare gravi lesioni personali (*1) o la perdita della vita, qualora il prodotto venga maneggiato in modo improprio.
 ATTENZIONE	Il testo evidenziato in questo modo indica che la mancata conformità alle indicazioni nell'avvertenza in questione potrebbe risultare in lievi lesioni personali (*2) o danni (*3) alle cose, qualora il prodotto venga maneggiato in modo improprio.

*1: il termine "gravi lesioni personali" si riferisce a perdita della vista, lesioni corporee, ustioni, scosse elettriche, fratture ossee, avvelenamento e altre lesioni personali che lasciano postumi e richiedono il ricovero in ospedale o terapie ambulatoriali a lungo termine.

*2: il termine "lievi lesioni personali" si riferisce a lesioni corporee, ustioni, scosse elettriche e altre lesioni personali che non richiedono il ricovero in ospedale o terapie ambulatoriali a lungo termine.

*3: il termine "danni alle cose" si riferisce a danni che si estendono a edifici, effetti personali domestici, bestiame domestico e animali da compagnia.

	AVVERTIMENTO (Rischio di incendio)	Questa indicazione è esclusivamente per il refrigerante R32. Il tipo di refrigerante è riportato sulla targhetta di identificazione dell'unità esterna. Qualora il tipo di refrigerante sia R32, questa unità utilizza un refrigerante infiammabile. Qualora si verifici una perdita di refrigerante e quest'ultimo entri in contatto col fuoco o parti riscaldanti, viene generato gas nocivo e sussiste il rischio di incendio.
	Leggere il MANUALE DEL PROPRIETARIO con attenzione prima dell'uso.	
	È richiesto che il personale di assistenza legga con attenzione il MANUALE DEL PROPRIETARIO e il MANUALE DI INSTALLAZIONE , prima dell'uso.	
	Ulteriori informazioni sono disponibili nel MANUALE DEL PROPRIETARIO , nel MANUALE DI INSTALLAZIONE e in documenti simili.	

Indicazione di avvertimento	Descrizione		
 <table border="1"> <tr> <td>WARNING</td> </tr> <tr> <td>ELECTRICAL SHOCK HAZARD Disconnect all remote electric power supplies before servicing.</td> </tr> </table>	WARNING	ELECTRICAL SHOCK HAZARD Disconnect all remote electric power supplies before servicing.	AVVERTIMENTO PERICOLO DI SCOSSA ELETTRICA Scollegare tutte le fonti di alimentazione elettrica remota, prima di sottoporre a interventi di assistenza.
WARNING			
ELECTRICAL SHOCK HAZARD Disconnect all remote electric power supplies before servicing.			
 <table border="1"> <tr> <td>WARNING</td> </tr> <tr> <td>Moving parts. Do not operate unit with grille removed. Stop the unit before the servicing.</td> </tr> </table>	WARNING	Moving parts. Do not operate unit with grille removed. Stop the unit before the servicing.	AVVERTIMENTO Parti mobili. Non far funzionare l'unità con la griglia rimossa. Arrestare l'unità prima di sottoporla ad assistenza.
WARNING			
Moving parts. Do not operate unit with grille removed. Stop the unit before the servicing.			
 <table border="1"> <tr> <td>CAUTION</td> </tr> <tr> <td>Do not touch the aluminum fins of the unit. Doing so may result in injury.</td> </tr> </table>	CAUTION	Do not touch the aluminum fins of the unit. Doing so may result in injury.	ATTENZIONE Non toccare le alette in alluminio dell'unità. In caso contrario, si potrebbero provocare lesioni personali.
CAUTION			
Do not touch the aluminum fins of the unit. Doing so may result in injury.			

1 Precauzioni per la sicurezza

Il produttore non si assume alcuna responsabilità per i danni causati dalla mancata osservazione delle descrizioni del presente manuale.

AVVERTIMENTO

Generali

- Prima d'iniziare l'installazione del condizionatore d'aria si raccomanda di leggere con attenzione il manuale d'installazione e di osservarne scrupolosamente ogni istruzione ivi fornita.
- Solo un installatore qualificato o un tecnico dell'assistenza qualificato sono autorizzati a installare l'unità. Se l'installazione non è stata eseguita correttamente si possono infatti verificare perdite d'acqua, scosse elettriche o un incendio.
- Per rabbocchi o sostituzioni, non utilizzare refrigeranti diversi da quello indicato. In caso contrario nel ciclo di refrigerazione si può generare una pressione eccessiva, che può generare guasti, esplosione del prodotto o pericolo per le persone.
- Prima di aprire la griglia della presa d'aria dell'unità interna o il pannello di servizio dell'unità esterna, impostare l'interruttore automatico sulla posizione OFF (spento). La mancata impostazione dell'interruttore automatico sulla posizione OFF (spento) potrebbe provocare scosse elettriche attraverso il contatto con le parti interne. Solo un installatore qualificato (*1) o un tecnico dell'assistenza qualificato (*1) sono autorizzati a rimuovere la griglia della presa d'aria dell'unità interna o il pannello di servizio dell'unità esterna e a svolgere il lavoro richiesto.
- Prima di effettuare i lavori di installazione, manutenzione, riparazione o rimozione, impostare l'interruttore automatico sulla posizione OFF (spento). In caso contrario, si potrebbero causare scosse elettriche.
- Sistemare un cartello con l'indicazione "Lavori in corso" in prossimità dell'interruttore automatico durante l'esecuzione di lavori di installazione, manutenzione, riparazione o rimozione. Qualora l'interruttore automatico sia impostato su ON (acceso) per errore, sussiste il pericolo di scosse elettriche.
- Solo un installatore qualificato (*1) o un tecnico dell'assistenza qualificato (*1) sono autorizzati a svolgere lavori in altezza utilizzando un supporto di altezza pari o superiore a 50 cm per rimuovere la griglia della presa d'aria dell'unità interna al fine dello svolgimento dei lavori.
- Durante l'installazione, la manutenzione e la rimozione, indossare guanti di protezione e indumenti da lavoro di sicurezza.
- Non toccare l'aletta in alluminio dell'unità. In caso contrario, si potrebbero provocare lesioni personali. Qualora sia necessario toccare l'aletta per qualche motivo, indossare prima guanti di protezione e indumenti da lavoro di sicurezza, quindi procedere.

- Quando si lavora in altezza, utilizzare una scala conforme allo standard ISO 14122, e attenersi alla procedura indicata nelle istruzioni della scala. Inoltre, indossare un casco per uso industriale come attrezzatura di protezione per intraprendere il lavoro.
- Questa unità è dotata di un sensore di rilevamento delle perdite di refrigerante per motivi di sicurezza; per essere efficace, l'unità deve essere sempre alimentata elettricamente dopo l'installazione, tranne quando si effettua lavoro di assistenza. Spegnerne l'interruttore di circuito causa il mancato funzionamento del sensore di rilevamento perdite di refrigerante e la mancata attivazione per rilevare perdite di refrigerante, causando un incendio.
- Non utilizzare refrigeranti diversi da R32 o R410A. Per il tipo di refrigerante, controllare l'unità esterna da combinare.
- Se il condizionatore deve essere trasportato manualmente, l'operazione deve essere effettuata da quattro o più persone.
- Se il condizionatore d'aria deve essere trasportato manualmente, l'operazione deve essere effettuata da due o più persone.
- La manutenzione deve essere eseguita solo come consigliato dal produttore. Non tentare di spostare o riparare l'unità da soli. L'unità contiene componenti ad alta tensione. La rimozione del coperchio e dell'unità centrale potrebbe esporre al rischio di elettrocuzione.
- Questo apparecchio è destinato all'uso da parte di utenti esperti o addestrati all'interno di negozi del settore o per uso commerciale da parte di utenti comuni.

Informazioni sul refrigerante R32

- L'apparecchio deve essere conservato in un luogo in cui non c'è utilizzo continuo di fonti di accensione (per esempio: fiamme libere, un dispositivo azionato a gas o un riscaldatore elettrico in funzione).
- Non perforare o bruciare i componenti del ciclo di refrigerazione.
- Non usare mezzi per accelerare il processo di sbrinamento o per pulire, tranne quelli consigliati dal produttore.
- Essere consapevoli del fatto che i refrigeranti potrebbero non avere un odore.
- Le tubazioni devono essere protette da danni fisici.
- La conformità alle normative nazionali sul gas deve essere rispettata.
- Se il sensore di rilevamento perdite di refrigerante rileva una perdita di refrigerante R32, una ventola sull'unità interna si aziona automaticamente per provocare un movimento dell'aria nell'ambiente. Il volume di movimentazione del flusso d'aria di ciascun modello è mostrato di seguito.

Modelli	Movimentazione flusso d'aria (m ³ /h)
RAV-RM561FT*	820
RAV-RM801FT*	930
RAV-RM1101FT*	1 660
RAV-RM1401FT*	1 760
RAV-RM1601FT*	1 760

Selezione della sede di installazione

- Se il condizionatore d'aria deve essere installato in un locale piccolo è necessario evitare che in caso di perdite il refrigerante raggiunga una concentrazione critica.
- Non installare in un luogo soggetto a possibili fughe di gas infiammabili. Qualora dovessero raggiungere una concentrazione elevata attorno ad esse potrebbero infatti causare un incendio.
- Per trasportare il condizionatore d'aria, indossare scarpe con calotte protettive aggiuntive per le dita dei piedi.
- Per trasportare il condizionatore d'aria, non afferrare le fascette che circondano la scatola di imballaggio. Qualora le fascette si rompano, si potrebbero subire lesioni personali.
- Non collocare apparecchi a combustione di alcun genere in luoghi che siano direttamente esposti al flusso d'aria prodotto dal condizionatore d'aria; in caso contrario, il condizionatore potrebbe provocare una combustione imperfetta.

- Quando un'unità esterna che utilizza il refrigerante R32 è combinata con l'unità interna, prestare attenzione all'area del pavimento nella stanza dell'installazione. L'unità non può essere installata in un ambiente con area del pavimento inferiore all'area minima del pavimento descritta nell'Appendice del presente Manuale di installazione.

Installazione

- Il condizionatore deve essere installato in un punto in grado di sostenerne adeguatamente il peso. Qualora la resistenza non sia sufficiente, l'unità potrebbe cadere e provocare lesioni personali.
- Attenersi alle istruzioni nel Manuale d'installazione per installare il condizionatore d'aria. La mancata osservanza di queste istruzioni potrebbe infatti causare la caduta o il ribaltamento delle unità, nonché divenire causa di rumore, vibrazioni, fuoriuscite d'acqua o altri problemi.
- Effettuare l'installazione considerando l'eventuale possibilità di vento forte o di terremoti. Se il condizionatore d'aria non è installato correttamente, un'unità può ribaltarsi o cadere, causando un incidente.
- Se durante l'installazione si verifica una fuga del gas refrigerante occorre ventilare subito l'ambiente. Se il gas refrigerante fuoriuscito entra in contatto con le fiamme, è possibile che vengano generati gas tossici, che potrebbero prendere fuoco.
- Utilizzare un carrello elevatore per trasportare le unità del condizionatore d'aria e per la loro installazione utilizzare un argano o un paranco.
- L'installazione delle tubazioni deve essere mantenuta al minimo.

Tubi del liquido refrigerante

- Installare il tubo del refrigerante stabilmente durante i lavori di installazione, prima di mettere in funzione il condizionatore d'aria. Se il compressore viene messo in funzione con la valvola aperta e senza il tubo del refrigerante, il compressore aspira aria e il circuito di refrigerazione raggiunge una pressione eccessiva, con la possibilità di causare lesioni personali.
- Serrare il dado svasato con una chiave torsiometrica come illustrato. Un serraggio eccessivo del dado svasato potrebbe causare delle spaccature nel lungo periodo, il che potrebbe provocare perdite di refrigerante.
- Una volta completata l'installazione è quindi di estrema importanza verificare che non vi siano perdite. Qualora si verifichi una perdita di gas refrigerante nella stanza e il gas entri a contatto con una sorgente di fiamme, per esempio un fornello di cucina, si potrebbero generare gas tossici, che potrebbero prendere fuoco.

- Quando il condizionatore d'aria è stato installato o trasferito, attenersi alle istruzioni nel Manuale d'installazione e spurgare completamente l'aria in modo che nessun altro gas si mescoli al refrigerante nel circuito di refrigerazione. Qualora non si effettui lo spurgo completo dell'aria, si potrebbe provocare un malfunzionamento del condizionatore d'aria.
- Per la prova di tenuta dell'aria è necessario utilizzare gas di azoto.
- Il tubo flessibile di carico deve essere collegato in modo tale da non essere lasco.

Cavi elettrici

- Solo un installatore qualificato (*1) o un tecnico dell'assistenza qualificato (*1) sono autorizzati a eseguire i lavori sull'impianto elettrico per il condizionatore d'aria. In nessuna circostanza tali lavori devono essere effettuati da una persona non qualificata, poiché un'esecuzione non appropriata dei lavori potrebbe provocare scosse elettriche e/o dispersioni di corrente.
- Per evitare di ricevere scosse elettriche, prima di eseguire collegamenti elettrici, riparare parti elettriche o condurre altre attività sull'impianto elettrico si raccomanda d'indossare guanti per elettricisti e scarpe e indumenti isolanti. Qualora non si indossino queste attrezzature protettive, si potrebbero provocare scosse elettriche.
- Utilizzare cablaggi che soddisfino le specifiche nel Manuale d'installazione e le direttive delle norme e nelle leggi locali. L'uso di cablaggi che non soddisfino le specifiche potrebbe provocare scosse elettriche, dispersioni di corrente, fumo e/o un incendio.
- Collegare il cavo di terra. (Cablaggio di messa a terra)
Una messa a terra incompleta causa scosse elettriche.
- Non collegare i cavi di messa a terra a tubi del gas, tubi dell'acqua, conduttori dei parafulmini o a cavi di messa a terra per cablaggi telefonici.
- Dopo aver completato i lavori di riparazione o di trasferimento, verificare che i cavi elettrici di messa a terra siano collegati correttamente.
- Installare un interruttore automatico che soddisfi le specifiche nel Manuale d'installazione e le direttive delle norme e delle leggi locali.
- Installare l'interruttore automatico in una sede che sia facilmente accessibile dall'agente.
- Quando si installa l'interruttore automatico all'aperto, installarne uno progettato per l'uso per esterno.
- In nessuna circostanza, il cavo di alimentazione o il cavo di collegamento dell'unità interna ed esterna deve essere collegato nel mezzo (collegamento usando un terminale senza saldature, ecc.)
Eventuali guasti al collegamento nelle sedi in cui il cavo è collegato nel mezzo possono provocare fumo e/o un incendio.

- I lavori di cablaggio elettrico devono essere effettuati in conformità alle normative vigenti e al manuale di installazione.
La mancata osservanza di questa indicazione espone al rischio di elettrocuzione o cortocircuito.
- Controllare che il cablaggio non sarà soggetto a usura, corrosione, pressione eccessiva, vibrazioni, spigoli vivi o altri effetti negativi dell'ambiente. Il controllo deve inoltre tener conto degli effetti dell'invecchiamento o delle vibrazioni continue da fonti quali compressori o ventilatori.

Prova di funzionamento

- Prima di far funzionare il condizionatore d'aria, dopo aver completato il lavoro, verificare che il coperchio della cassetta dei componenti elettrici dell'unità interna e il pannello di servizio dell'unità esterna siano chiusi, e impostare l'interruttore automatico sulla posizione ON (acceso). Qualora si accenda l'unità senza aver prima eseguito questi controlli, si potrebbe subire una scossa elettrica.
- Se si nota il verificarsi di un problema di qualche tipo con il condizionatore d'aria (ad esempio è stato visualizzato un codice di controllo, si sente odore di bruciato, si sentono suoni anomali, il condizionatore d'aria non raffredda o non riscalda, oppure è presente una perdita d'acqua), non toccare da soli il condizionatore d'aria, ma impostare l'interruttore automatico sulla posizione OFF (spento) e contattare un tecnico dell'assistenza qualificato. Adottare delle misure per assicurare che l'unità non venga accesa (ad esempio scrivendo "fuori servizio" in prossimità dell'interruttore) fino all'arrivo di un tecnico dell'assistenza qualificato. L'uso continuato del condizionatore d'aria in questa condizione anomala potrebbe divenire causa di problemi meccanici, generare scosse elettriche o causare altri problemi.
- Al termine del lavoro, utilizzare un misuratore di isolamento (500 VMΩ) per controllare che la resistenza sia 1 MΩ tra la sezione sotto carico elettrico e la sezione di metallo che non è sotto carico elettrico (sezione di terra). Qualora il valore di resistenza sia basso, potrebbe verificarsi un grave problema, quale una dispersione o una scossa elettrica, dal lato dell'utente.
- Al completamento del lavoro di installazione, controllare eventuali perdite di refrigerante e controllare la resistenza di isolamento e lo scarico dell'acqua. Quindi, eseguire un funzionamento di prova per controllare che il condizionatore d'aria funzioni correttamente.

Spiegazioni fornite all'utente

- Al completamento del lavoro di installazione, comunicare all'utente dove sia situato l'interruttore automatico. Qualora l'utente non sappia dove si trovi l'interruttore automatico, non sarà in grado di disattivarlo, nell'eventualità che si verifichi un problema con il condizionatore d'aria.

-
- Dopo l'installazione, attenersi alle indicazioni nel manuale utente per spiegare al cliente come utilizzare ed effettuare la manutenzione dell'unità.

Trasferimento

- Solo un installatore qualificato (*1) o un tecnico dell'assistenza qualificato (*1) sono autorizzati a trasferire il condizionatore d'aria. È pericoloso far trasferire il condizionatore d'aria da una persona non qualificata, in quanto si potrebbero provocare incendi, scosse elettriche, lesioni personali, perdite d'acqua, rumori e/o vibrazioni.
- Quando si eseguono lavori di svuotamento del refrigerante (Pump-down), spegnere il compressore prima di scollegare il tubo del refrigerante. Eseguendo questo scollegamento con la valvola di servizio aperta e il compressore in funzione si causerebbe l'aspirazione dell'aria o di altri gas eventualmente presenti nell'atmosfera, elevando in tal modo la pressione interna al circuito refrigerante a un livello eccessivamente alto con possibili rotture, lesioni personali o problemi di funzionamento.

(*1) Consultare la "Definizione di installatore qualificato o tecnico dell'assistenza qualificato".

ATTENZIONE

Questo condizionatore ha adottato un refrigerante HFC (R32 o R410A) che non distrugge lo strato di ozono.

- Dato che il refrigerante R32 o R410A è facilmente influenzato da impurità, come umidità, patina ossidata, olio, ecc., a causa dell'alta pressione, fare attenzione a non permettere che umidità, sporco, refrigerante esistente, olio refrigerante per macchina, ecc., si mescolino nel ciclo del refrigerante durante il lavoro di installazione.
 - Un utensile speciale per il refrigerante R32 o R410A è necessario per l'installazione.
 - Utilizzare materiali di tubazione nuovi e puliti per il tubo di collegamento, in modo che umidità e sporco non vengano mescolati insieme durante il lavoro di installazione.
 - Quando si utilizzano tubazioni esistenti, seguire il manuale di installazione in dotazione con l'unità esterna.
 - Fare attenzione al funzionamento della ventola quando l'interruttore di circuito è acceso. Se il sensore di rilevamento perdite di refrigerante rileva la perdita di refrigerante, la ventola ruota automaticamente anche quando il condizionatore d'aria si arresta. Fare attenzione a non ferirsi con la ventola.
-

Gracias por haber adquirido este aparato de aire acondicionado Toshiba. Lea atenta y completamente estas instrucciones que incluyen información importante conforme a la "Directiva de Maquinaria" (Directiva 2006/42/CE), y asegúrese de entenderlas bien. Después de leer estas instrucciones, asegúrese de guardarlas en un lugar seguro junto con el manual del propietario y el manual de instalación incluido con el producto.

Denominación genérica: Aire acondicionado

Definición de instalador cualificado o persona de mantenimiento cualificada

El aparato de aire acondicionado deberá ser instalado, mantenido, reparado y desechado por un instalador cualificado o por una persona de mantenimiento cualificada. Cuando se tengan que efectuar cualquiera de estos trabajos, acuda a un instalador cualificado o a una persona de mantenimiento cualificada para que los haga por usted.

Un instalador cualificado o una persona de mantenimiento cualificada es un agente con las cualificaciones y conocimientos descritos en la tabla que aparece a continuación.

Agente	Cualificaciones y conocimientos que debe tener el agente
Instalador cualificado	<ul style="list-style-type: none"> El instalador cualificado es una persona que se dedica a la instalación, mantenimiento, traslado y retirada de los aparatos de aire acondicionado fabricados por Toshiba Carrier Corporation. Dicha persona habrá recibido formación relativa a la instalación, mantenimiento, traslado y retirada de aparatos de aire acondicionado fabricados por Toshiba Carrier Corporation, o, de otro modo, habrá sido instruida en dichas operaciones por otra u otras personas que hayan recibido formación en la materia y que por tanto posean amplios conocimientos relativos a dichas operaciones. El instalador cualificado que esté autorizado para realizar los trabajos eléctricos propios de la instalación, traslado y retirada poseerá las cualificaciones relativas a dichos trabajos eléctricos, de conformidad con la legislación local vigente, y habrá recibido formación relativa a las tareas eléctricas a realizar en los aparatos de aire acondicionado fabricados por Toshiba Carrier Corporation, o, de otro modo, habrá sido instruido en dichas tareas por otra u otras personas que hayan recibido formación en la materia y que por tanto posean amplios conocimientos relativos a dichas operaciones. El instalador cualificado que esté autorizado para realizar los trabajos de canalización y manejo del refrigerante propios de la instalación, traslado y retirada poseerá las cualificaciones relativas a dichos trabajos de canalización y manejo del refrigerante, de conformidad con la legislación local vigente, y habrá recibido formación relativa a las tareas de canalización y uso del refrigerante a realizar en los aparatos de aire acondicionado fabricados por Toshiba Carrier Corporation, o, de otro modo, habrá sido instruido en dichas tareas por otra u otras personas que hayan recibido formación en la materia y que por tanto posean amplios conocimientos relativos a dichas operaciones. El instalador cualificado que esté autorizado para trabajar en alturas habrá recibido formación relativa a la realización de trabajos en altura con los aparatos de aire acondicionado fabricados por Toshiba Carrier Corporation, o, de otro modo, habrá sido instruido en dichas tareas por otra u otras personas que hayan recibido formación en la materia y que por tanto posean amplios conocimientos relativos a dichos trabajos.
Técnico cualificado	<ul style="list-style-type: none"> La persona de mantenimiento cualificado es una persona que se dedica a la instalación, reparación, mantenimiento, traslado y retirada de los aparatos de aire acondicionado fabricados por Toshiba Carrier Corporation. Dicha persona habrá recibido formación relativa a la instalación, reparación, mantenimiento, traslado y retirada de aparatos de aire acondicionado fabricados por Toshiba Carrier Corporation, o, de otro modo, habrá sido instruida en dichas operaciones por otra u otras personas que hayan recibido formación en la materia y que por tanto posean amplios conocimientos relativos a dichas operaciones. La persona de mantenimiento cualificada que esté autorizada para realizar los trabajos eléctricos propios de la instalación, reparación, traslado y retirada poseerá las cualificaciones relativas a dichos trabajos eléctricos, de conformidad con la legislación local vigente, y habrá recibido formación relativa a las tareas eléctricas a realizar en los aparatos de aire acondicionado fabricados por Toshiba Carrier Corporation, o, de otro modo, habrá sido instruida en dichas tareas por otra u otras personas que hayan recibido formación en la materia y que por tanto posean amplios conocimientos relativos a dichas operaciones. La persona de mantenimiento cualificada que esté autorizada para realizar los trabajos de canalización y manejo del refrigerante propios de la instalación, reparación, traslado y retirada poseerá las cualificaciones relativas a dichos trabajos de canalización y manejo del refrigerante, de conformidad con la legislación local vigente, y habrá recibido formación relativa a las tareas de canalización y uso del refrigerante a realizar en los aparatos de aire acondicionado fabricados por Toshiba Carrier Corporation, o, de otro modo, habrá sido instruida en dichas tareas por otra u otras personas que hayan recibido formación en la materia y que por tanto posean amplios conocimientos relativos a dichas operaciones. La persona de mantenimiento cualificada que esté autorizada para trabajar en alturas habrá recibido formación relativa a la realización de trabajos en altura con los aparatos de aire acondicionado fabricados por Toshiba Carrier Corporation, o, de otro modo, habrá sido instruida en dichas tareas por otra u otras personas que hayan recibido formación en la materia y que por tanto posean amplios conocimientos relativos a dichos trabajos.

Definición del equipo de protección

Cuando el aparato de aire acondicionado vaya a ser transportado, instalado, mantenido, reparado o desechado, póngase guantes de protección y ropas de trabajo seguras. Además de tal equipo de protección normal, póngase el equipo de protección descrito más abajo cuando realice trabajos especiales como los descritos en la tabla de abajo. No ponerse el equipo de protección adecuado puede resultar peligroso porque quedará más expuesto a sufrir lesiones, quemaduras, descargas eléctricas y otros daños.

Trabajo realizado	Equipo de protección usado
Todo tipo de trabajos	Guantes de protección Ropa de trabajo segura
Trabajo relacionado con equipos eléctricos	Ropa de protección contra descargas eléctricas Zapatos aislantes Guantes para proporcionar protección contra descargas eléctricas
Trabajos en altura (50 cm o más)	Cascos de seguridad de uso industrial
Transporte de objetos pesados	Calzado con protección adicional en las punteras
Reparación de la unidad exterior	Guantes para proporcionar protección contra descargas eléctricas

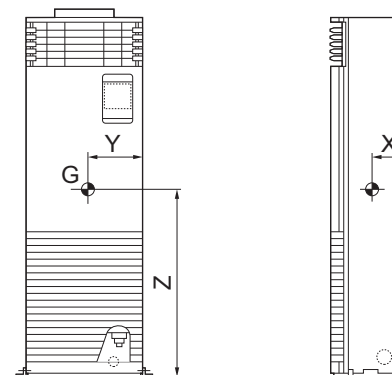

Centro de la gravedad

Nombre del modelo	X (mm)	Y (mm)	Z (mm)
RAV-RM561FT-EN/ES	85	285	820
RAV-RM801FT-EN/ES			
RAV-RM1101FT-EN/ES	195	290	860
RAV-RM1401FT-EN/ES			
RAV-RM1601FT-EN/ES			



■ Advertencias en cuanto a la unidad de aire acondicionado





Estas precauciones de seguridad describen cuestiones importantes concernientes a la seguridad a fin de prevenir lesiones a usuarios o a otras personas y daños a la propiedad. Por favor, lea este manual después de entender los siguientes contenidos (significados de las indicaciones) y asegúrese de seguir las instrucciones.



Indicación	Significado de la indicación
 ADVERTENCIA	El texto impreso en este formato indica que la omisión de las instrucciones contenidas en la advertencia podría resultar en lesiones corporales graves (*1) o muertes si el producto no se maneja correctamente.
 PRECAUCIÓN	El texto impreso en este formato indica que la omisión de las instrucciones contenidas en la precaución podría resultar en lesiones leves (*2) o en daños (*3) a la propiedad si el producto no se maneja correctamente.

*1: Las lesiones corporales graves abarcan pérdida de visión, heridas, quemaduras, descargas eléctricas, fractura de huesos, envenenamiento y otros daños que dejen secuelas y requieran hospitalización o tratamiento ambulatorio prolongados.

*2: Las lesiones leves hacen referencia a heridas, quemaduras, descargas eléctricas y otros daños que no requieran hospitalización ni tratamiento ambulatorio prolongados.

*3: Los daños a la propiedad comprenden daños al edificio, enseres domésticos, animales domésticos o mascotas.

	ADVERTENCIA (Riesgo de incendio)	Esta marca está reservada exclusivamente para el refrigerante R32. El tipo de refrigerante aparece escrito en la placa de identificación de la unidad exterior. En caso de que el tipo de refrigerante sea R32, esta unidad utiliza un refrigerante inflamable. Si se producen fugas de refrigerante y este entra en contacto con fuego o con la parte de calefacción, generará gases dañinos y habrá riesgo de incendio.
	Lea atentamente el MANUAL DE USUARIO antes de la operación.	
	El personal de servicio técnico debe leer atentamente el MANUAL DE USUARIO y el MANUAL DE INSTALACIÓN antes de la operación.	
	Hay más información disponible en el MANUAL DE USUARIO, el MANUAL DE INSTALACIÓN y demás documentación.	

Indicación de advertencia	Descripción		
 <table border="1"> <tr> <td>WARNING</td> </tr> <tr> <td>ELECTRICAL SHOCK HAZARD Disconnect all remote electric power supplies before servicing.</td> </tr> </table>	WARNING	ELECTRICAL SHOCK HAZARD Disconnect all remote electric power supplies before servicing.	ADVERTENCIA PELIGRO DE DESCARGA ELÉCTRICA Desconecte todos los suministros eléctricos remotos antes de hacer reparaciones.
WARNING			
ELECTRICAL SHOCK HAZARD Disconnect all remote electric power supplies before servicing.			
 <table border="1"> <tr> <td>WARNING</td> </tr> <tr> <td>Moving parts. Do not operate unit with grille removed. Stop the unit before the servicing.</td> </tr> </table>	WARNING	Moving parts. Do not operate unit with grille removed. Stop the unit before the servicing.	ADVERTENCIA Piezas móviles. No utilice la unidad con la rejilla retirada. Pare la unidad antes de hacer reparaciones.
WARNING			
Moving parts. Do not operate unit with grille removed. Stop the unit before the servicing.			
 <table border="1"> <tr> <td>CAUTION</td> </tr> <tr> <td>Do not touch the aluminum fins of the unit. Doing so may result in injury.</td> </tr> </table>	CAUTION	Do not touch the aluminum fins of the unit. Doing so may result in injury.	PRECAUCIÓN No toque las aletas de aluminio del aparato. De lo contrario, podrían producirse lesiones personales.
CAUTION			
Do not touch the aluminum fins of the unit. Doing so may result in injury.			

1 Precauciones de seguridad

El fabricante no asumirá ninguna responsabilidad por los daños causados por no seguir las descripciones de este manual.

ADVERTENCIA

General

- Antes de empezar a instalar el acondicionador de aire, lea atentamente el manual de instalación y siga sus instrucciones para instalarlo.
- Solo un instalador cualificado o una persona de mantenimiento cualificada tiene permiso para realizar los trabajos de instalación. La instalación incorrecta puede provocar fugas de agua, descargas eléctricas o incendios.
- No utilice ningún refrigerante distinto del especificado como complemento o sustituto. Si lo hace, se podría generar una presión extremadamente alta en el ciclo de refrigeración, lo que podría causar un fallo en el producto, la explosión de este o daños físicos.
- Antes de abrir la rejilla de toma de aire de la unidad interior o el panel de servicio de la unidad exterior, ponga el disyuntor en la posición OFF (apagado). Si no se coloca el disyuntor en la posición OFF (apagado), se puede producir una descarga eléctrica por contacto con las piezas interiores. Sólo un instalador cualificado (*1) o una persona de servicio cualificada (*1) tiene permitido retirar la rejilla de admisión de la unidad interior o el panel de servicio de la unidad exterior y hacer el trabajo necesario.
- Antes de realizar la instalación, el mantenimiento, la reparación o la desinstalación, coloque el disyuntor en la posición de OFF (apagado). De lo contrario se pueden producir descargas eléctricas.
- Ponga un aviso que diga "trabajo en curso" cerca del disyuntor mientras se realiza el trabajo de instalación, mantenimiento, reparación o desecho. Si el disyuntor se pone en ON (encendido) por error existe el peligro de que se produzcan descargas eléctricas.
- Sólo un instalador cualificado (*1) o una persona de servicio cualificada (*1) tiene permiso para realizar trabajos en lugares altos usando una base de 50 cm o más o para quitar la rejilla de admisión de la unidad interior para realizar otros trabajos.
- Utilice guantes de protección y ropa de trabajo segura durante la instalación, reparación y retirada.
- No toque la aleta de aluminio de la unidad. Si lo hace, podría lesionarse. Si por algún motivo tuviera que tocar la aleta, póngase primero guantes de protección y ropa de trabajo segura, y luego empiece a trabajar.

- Cuando trabaje en alturas, utilice una escalera que cumpla la norma ISO 14122 y siga los procedimientos indicados en las instrucciones de la escalera. Póngase también un casco de uso industrial como equipo de protección para hacer el trabajo.
- Esta unidad está equipada con un sensor de detección de fugas de refrigerante por motivos de seguridad. Para que sea efectivo, la unidad debe ser alimentada eléctricamente en todo momento después de la instalación, excepto cuando se realiza el mantenimiento. Apagar el disyuntor hace que el sensor de detección de fugas de refrigerante no funcione y que no sea capaz de detectar fugas de refrigerante, causando un incendio.
- No use refrigerante que no sea R32 o R410A. Para obtener información sobre el tipo de refrigerante, compruebe la unidad exterior a combinar.
- El acondicionador de aire debe transportarse en condiciones estables. Si alguna pieza del producto está rota, póngase en contacto con el proveedor.
- Cuando el acondicionador de aire deba transportarse a mano, deberán hacerlo cuatro o más personas.
- El mantenimiento se realizará solo según lo recomendado por el fabricante. No mueva ni repare ninguna unidad usted mismo. La unidad contiene alto voltaje en su interior. Podría recibir una descarga eléctrica al retirar la cubierta y la unidad principal.
- El uso de este aparato está destinado a personal especializado o a usuarios con formación para tiendas e industria ligera, o a un uso comercial para el público en general.

Acerca del refrigerante R32

- El aparato debe almacenarse en una habitación sin fuentes de ignición que funcionen continuamente (por ejemplo: llamas abiertas, un aparato a gas en funcionamiento o un calentador eléctrico en funcionamiento).
- No perfore ni queme las piezas del ciclo del refrigerante.
- No utilice medios para acelerar el proceso de descongelación o para limpiar, aparte de los recomendados por el fabricante.
- Tenga en cuenta que los refrigerantes pueden no contener un olor.
- Las tuberías deben estar protegidas de daños físicos.
- Se debe observar el cumplimiento de la normativa nacional sobre gas.
- Si el sensor de detección de fugas de refrigerante detecta una fuga de refrigerante R32, un ventilador en la unidad interior funciona automáticamente para agitar el aire de la habitación. El volumen del flujo de aire de agitación de cada modelo se muestra a continuación.

Nombre del modelo	Flujo de aire de agitación (m ³ /h)
RAV-RM561FT*	820
RAV-RM801FT*	930
RAV-RM1101FT*	1 660
RAV-RM1401FT*	1 760
RAV-RM1601FT*	1 760

Selección del lugar de instalación

- Cuando la unidad de aire acondicionado se instale en una habitación pequeña, asegúrese de que las medidas son adecuadas para garantizar que la concentración de refrigerante que se produce por la fuga de este en la habitación no sobrepase el nivel crítico.
- No instale el producto en lugares donde puedan existir fugas de gases inflamables. Si se produjera una fuga de gas y este se acumulara alrededor de la unidad, podría prender y provocarse un incendio.
- Cuando transporte el aparato de aire acondicionado, póngase zapatos con protección adicional en las punteras.
- Para transportar el acondicionador de aire, no lo agarre por las bandas de alrededor del cartón de embalaje. Podría lesionarse en caso de rotura de las bandas.
- No ponga ningún aparato de combustión en un lugar expuesto directamente al aire procedente del acondicionador de aire, de lo contrario, la combustión no sería perfecta.

- Cuando se combina una unidad exterior que usa refrigerante R32 con una unidad interior, preste atención al área del suelo en la habitación en la que se instalará. La unidad no puede instalarse en una habitación con un área del suelo más pequeña que el área del suelo mínima descrita en el Apéndice de este Manual de instalación.

Instalación

- Instale la unidad de aire acondicionado asegurándose de que queda bien sujeta en una ubicación cuya base pueda soportar el peso adecuadamente. Si la resistencia no es suficiente, la unidad puede caerse y causar lesiones.
- Siga las instrucciones del manual de instalación para instalar el aparato de aire acondicionado. De no seguir esta instrucción, el producto podría caer o volcarse, así como generar más ruido, vibraciones, fugas de agua y otros problemas.
- Lleve a cabo el procedimiento de instalación especificado para proteger la unidad contra posibles vientos fuertes y terremotos. Si no se instala la unidad de aire acondicionado correctamente, podría caer o volcarse y causar un accidente.
- Si se producen fugas de gas refrigerante durante la instalación, ventile inmediatamente la habitación. Si el gas refrigerante liberado durante la fuga entra en contacto con fuego, pueden generarse gases tóxicos, que pueden incendiarse.
- Utilice una carretilla elevadora para transportar las unidades de aire acondicionado y cabestrantes o montacargas para la instalación.
- La instalación de tuberías debe ser mínima.

Tubería del refrigerante

- Instale firmemente el tubo del refrigerante durante los trabajos de instalación antes de poner en funcionamiento el aparato de aire acondicionado. Si el compresor funciona con su válvula abierta y sin tubo de refrigerante, el compresor succionará aire y los ciclos de refrigeración tendrán una presión excesiva, lo que puede causar lesiones.
- Apriete la tuerca abocinada con una llave de ajuste dinamométrica como se indica. Un apriete excesivo de la tuerca abocinada puede causar grietas en la misma con el paso del tiempo, lo que podría causar fugas de refrigerante.
- Tras la instalación, asegúrese de que no existen fugas de gas refrigerante. Si se produce una fuga de gas refrigerante en la habitación y hay una fuente de fuego próxima, como una cocina, podría generarse gas nocivo, que puede incendiarse.
- Cuando el acondicionador de aire haya sido instalado o trasladado, siga las instrucciones del manual de instalación y purgue completamente el aire para que no se mezclen otros gases que no sean el refrigerante en el ciclo de refrigeración. Si el aire no se purga completamente puede que el acondicionador de aire funcione de forma incorrecta.

- Para la prueba de hermeticidad al aire deberá usarse gas nitrógeno.
- La manguera de carga deberá conectarse de forma que no esté floja.

Cableado eléctrico

- Sólo un instalador cualificado (*1) o una persona de servicio cualificada (*1) tiene permitido realizar el trabajo eléctrico del aparato de aire acondicionado. Este trabajo no deberá hacerlo, bajo ninguna circunstancia, una persona que no esté cualificada, ya que si el trabajo se efectúa de forma incorrecta, existe el peligro de que se produzcan descargas eléctricas y/o fugas eléctricas.
- Para conectar los cables eléctricos, reparar los componentes eléctricos o realizar otros trabajos con equipos eléctricos, póngase guantes y ropa para protegerse de las descargas eléctricas, así como zapatos aislantes. Si no se pone este equipo de protección puede recibir descargas eléctricas.
- Use cables que cumplan con las especificaciones del manual de instalación y las estipulaciones de las normas y leyes locales. El uso de cables que no cumplen con las especificaciones puede dar origen a descargas eléctricas, fugas eléctricas, humo y/o incendios.
- Conecte la toma de tierra. (Masa)
Una conexión a tierra incompleta provocará descargas eléctricas.
- No conecte la toma de tierra a tuberías de gas o agua, a un pararrayos ni a una toma de tierra de teléfono.
- Cuando haya finalizado el trabajo de reparación o reubicación, compruebe que la toma de tierra esté conectada adecuadamente.
- Instale un disyuntor que cumpla con las especificaciones del manual de instalación y con las estipulaciones de las normas y las leyes locales.
- Instale el disyuntor donde el agente pueda tener acceso a él fácilmente.
- Cuando instale el disyuntor en el exterior, instale uno diseñado para ser usado en exteriores.
- Bajo ninguna circunstancia se deben conectar el cable del suministro de alimentación o el cable de conexión interior y exterior por el medio (conexión mediante un terminal sin soldadura, etc.)
Los problemas de conexión en lugares donde el cable se conecta por el medio podrían generar humo y/o un incendio.
- El cableado eléctrico deberá realizarse de conformidad con la legislación local vigente y el Manual de instalación.
No se ser así, podría producirse una electrocución o un cortocircuito.
- Compruebe que el cableado no esté sujeto a desgaste, corrosión, presión excesiva, vibración, bordes afilados o cualquier otro efecto ambiental adverso. La comprobación también debe tener en cuenta los efectos del envejecimiento o la vibración continua de fuentes como compresores o ventiladores.

Prueba de funcionamiento

- Antes de utilizar el acondicionador de aire después de completar el trabajo de instalación, compruebe que la cubierta de la caja de componentes eléctricos de la unidad interior y del panel de servicio de la unidad exterior esté cerrada, y ponga el disyuntor en la posición ON (encendido). Si conecta la alimentación sin realizar primero estas comprobaciones, puede recibir una descarga eléctrica.
- Si surge cualquier problema (por ejemplo, si aparece un código de comprobación en la pantalla, huele a quemado, se producen sonidos anormales, la unidad no enfría o no calienta o se produce una fuga de agua) con la unidad de aire acondicionado, no la toque usted mismo; coloque el disyuntor en la posición de OFF (apagado) y póngase en contacto con personal de servicio cualificado. Tome medidas (colocando un aviso de "Fuera de servicio" cerca del disyuntor, por ejemplo) para asegurar que la alimentación no se conecte antes de que llegue la persona de mantenimiento cualificada. Si se continúa utilizando la unidad de aire acondicionado con la anomalía, los problemas mecánicos podrían generar otras complicaciones o provocar descargas eléctricas u otro tipo de problemas.
- Después de terminar el trabajo, utilice el verificador de aislamiento (500 VMΩ) para verificar que la resistencia sea de 1 MΩ o más entre la sección de carga y la sección de metal de no carga (sección de tierra). Si el valor de la resistencia es bajo, esto se debe a un fallo como, por ejemplo, una fuga o una descarga eléctrica en el lado del usuario.
- Al completar el trabajo de instalación, compruebe que no haya fugas de refrigerante, y también la resistencia del aislamiento y el drenaje de agua. A continuación, efectúe una prueba de funcionamiento para comprobar si el acondicionador de aire funciona correctamente.

Explicaciones para dar al usuario

- Al finalizar el trabajo de instalación, indique al usuario dónde se encuentra el disyuntor. Si el usuario no sabe dónde está el disyuntor, él o ella no podrán desconectar la alimentación en el caso de que se produzca un fallo en el acondicionador de aire.
- Tras finalizar la instalación, consulte el manual del propietario para explicarle al cliente cómo utilizar y cuidar la unidad.

Traslado

- Sólo un instalador cualificado (*1) o una persona de servicio cualificada (*1) tiene permiso para recolocar el aparato de aire acondicionado. Es peligroso para el aparato de aire acondicionado que sea recolocado por un individuo no cualificado, porque se puede producir un incendio, descargas eléctricas, lesiones, fugas de agua, ruido y/o vibración.

-
- Cuando realice trabajos de bombeo de vacío, cierre el compresor antes de desconectar el tubo del refrigerante. Si se desconecta el tubo de refrigerante con la válvula de mantenimiento abierta y el compresor aún en marcha, se aspirará aire u otro gas, elevando la presión dentro del ciclo de refrigeración a niveles excesivamente altos, lo que podrá provocar roturas, lesiones u otros problemas.

(*1) Consulte la "Definición de instalador cualificado o persona de servicio cualificada".

PRECAUCIÓN

Este aparato de aire acondicionado incorpora el refrigerante HFC (R32 o R410A) respetuoso con la capa de ozono.

- Puesto que el refrigerante R32 o R410A se ve afectado fácilmente por impurezas tales como la humedad, películas de óxido, aceite, etc., debido a la alta presión, tenga cuidado para no permitir que la humedad, la suciedad, el refrigerante existente, el aceite de la máquina de refrigeración, etc., se mezclen en el ciclo de refrigeración durante las tareas de instalación.
 - Para la instalación, es necesaria una herramienta especial para el refrigerante R32 o R410A.
 - Use materiales de tubería nuevos y limpios para la tubería de conexión de modo que la humedad y la suciedad no se mezclen durante las tareas de instalación.
 - Al usar las tuberías existentes, siga el manual de instalación adjunto con la unidad exterior.
 - Tenga cuidado con el funcionamiento del ventilador cuando el disyuntor esté encendido. Si el sensor de detección de fugas de refrigerante detecta la fuga de refrigerante, un ventilador gira automáticamente incluso cuando se detiene un aire acondicionado. Tenga cuidado de no ser herido por el ventilador.
-

Obrigado por ter adquirido este ar condicionado Toshiba.

Leia cuidadosamente estas instruções contendo informações importantes em conformidade com a “Diretiva de Maquinaria” (Diretiva 2006/42/CE), e certifique-se de que as compreende.

Depois de ler estas instruções, certifique-se de que as guarda juntamente com o Manual do Proprietário e o Manual de Instalação fornecidos com o produto.

Denominação genérica: Ar Condicionado

Definição de Instalador Qualificado ou de Técnico de Assistência Qualificado

O ar condicionado deve ser instalado, mantido, reparado e eliminado por um instalador qualificado ou um técnico de assistência qualificado. Quando for necessário efectuar qualquer um destes trabalhos, peça a um instalador qualificado ou a um técnico de assistência qualificado para efectuar estes trabalhos.

Um instalador qualificado ou um técnico de assistência qualificado é um agente com as qualificações e os conhecimentos descritos na tabela abaixo.

Agente	Qualificações e conhecimentos necessários do agente
Instalador qualificado	<ul style="list-style-type: none"> O instalador qualificado é uma pessoa que instala, dá manutenção a, muda de lugar e remove os ares condicionados fabricados pela Toshiba Carrier Corporation. Esta pessoa deve ter formação para instalar, dar manutenção a, mudar de lugar e remover ares condicionados fabricados pela Toshiba Carrier Corporation ou, como alternativa, deve ter sido instruída nessas operações por parte de indivíduos com a formação devida e, portanto, que adquiriram todo o conhecimento relacionado com estas operações. O instalador qualificado que tem permissão para levar a cabo as ligações eléctricas envolvidas na instalação, deslocação e remoção tem as qualificações necessárias para realizar essas tarefas conforme estipulado pelas leis e regulamentos locais, sendo uma pessoa que fez formação nas matérias relacionadas com trabalho eléctrico nos ares condicionados fabricados pela Toshiba Carrier Corporation ou, como alternativa, que foi instruída nessas matérias por parte de indivíduos com a formação devida e, portanto, que adquiriram todo o conhecimento relacionado com este trabalho. O instalador qualificado que tem permissão para realizar as tarefas de manuseamento do refrigerante e de instalação das tubagens envolvidas na instalação, deslocação e remoção dos aparelhos tem as qualificações necessárias para o manuseamento do refrigerante e a instalação das tubagens conforme estipulado pelas leis e regulamentos locais, sendo uma pessoa que fez formação nas matérias relacionadas com o manuseamento de refrigerante e a instalação de tubagens nos ares condicionados fabricados pela Toshiba Carrier Corporation ou, como alternativa, que foi instruída nessas matérias por parte de indivíduos com a formação devida e, portanto, que adquiriram todo o conhecimento relacionado com estas tarefas. O instalador qualificado, a quem é permitido trabalhar em altura, foi formado em matérias relacionadas com o trabalho em altura com ares condicionados fabricados pela Toshiba Carrier Corporation ou, como alternativa, foi instruído nessas matérias por indivíduos com a formação devida e, portanto, que adquiriram todo o conhecimento relacionado com este trabalho.
Técnico de assistência qualificado	<ul style="list-style-type: none"> O técnico de assistência qualificado é uma pessoa que instala, repara, dá manutenção a, muda de lugar e remove os ares condicionados fabricados pela Toshiba Carrier Corporation. Esta pessoa deve ter formação para instalar, reparar, dar manutenção a, mudar de lugar e remover ares condicionados fabricados pela Toshiba Carrier Corporation ou, como alternativa, deve ter sido instruído nessas operações por parte de indivíduos com a formação devida e, portanto, que adquiriram todo o conhecimento relacionado com estas operações. O técnico de assistência qualificado que tem permissão para levar a cabo as ligações eléctricas envolvidas na instalação, reparação, deslocação e remoção tem as qualificações necessárias para realizar essas tarefas conforme estipulado pelas leis e regulamentos locais, sendo uma pessoa que fez formação nas matérias relacionadas com trabalho eléctrico nos ares condicionados fabricados pela Toshiba Carrier Corporation ou, como alternativa, que foi instruída nessas matérias por parte de indivíduos com a formação devida e, portanto, que adquiriram todo o conhecimento relacionado com este trabalho. O técnico de assistência qualificado que tem permissão para realizar as tarefas de manuseamento do refrigerante e de instalação das tubagens envolvidas na instalação, reparação, deslocação e remoção dos aparelhos tem as qualificações necessárias para o manuseamento do refrigerante e a instalação das tubagens conforme estipulado pelas leis e regulamentos locais, sendo uma pessoa que fez formação nas matérias relacionadas com o manuseamento de refrigerante e a instalação de tubagens nos ares condicionados fabricados pela Toshiba Carrier Corporation ou, como alternativa, que foi instruída nessas matérias por parte de indivíduos com a formação devida e, portanto, que adquiriram todo o conhecimento relacionado com estas tarefas. O técnico de assistência qualificado, a quem é permitido trabalhar em altura, foi formado em matérias relacionadas com o trabalho em altura com ares condicionados fabricados pela Toshiba Carrier Corporation ou, como alternativa, foi instruído nessas matérias por indivíduos com a formação devida e, portanto, que adquiriram todo o conhecimento relacionado com este trabalho.

Definição do Equipamento de Protecção

Quando transportar, instalar, manter, reparar ou eliminar o aparelho de ar condicionado, utilize luvas de protecção e vestuário de trabalho de segurança.

Além deste equipamento de protecção normal, utilize o equipamento de protecção descrito abaixo quando efectuar o trabalho especial descrito detalhadamente na tabela abaixo.

A não utilização do equipamento de protecção adequado é perigoso porque fica mais susceptível a lesões, queimaduras, choques eléctricos e outras lesões.

Trabalho efectuado	Equipamento de protecção usado
Todos os tipos de trabalhos	Luvas de protecção Vestuário de trabalho de segurança
Trabalho eléctrico	Vestuário para proteger contra choques eléctricos Sapatos isoladores Luvas para protecção contra choques eléctricos
Trabalhos em altura (50 cm ou mais)	Capacetes industriais
Transporte de objectos pesados	Sapatos com protecção adicional para os dedos dos pés
Reparação da unidade exterior	Luvas para protecção contra choques eléctricos

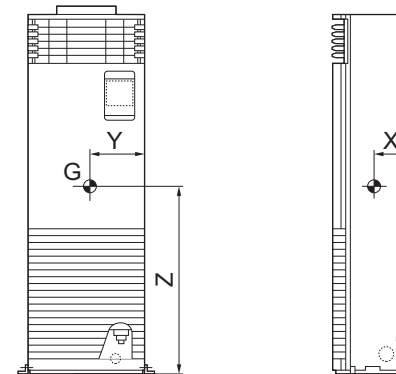

Centro de gravidade

Nome do modelo	X (mm)	Y (mm)	Z (mm)
RAV-RM561FT-EN/ES	85	285	820
RAV-RM801FT-EN/ES			
RAV-RM1101FT-EN/ES	195	290	860
RAV-RM1401FT-EN/ES			
RAV-RM1601FT-EN/ES			



■ Indicações de aviso sobre o ar condicionado





Estas precauções de segurança descrevem questões importantes em matéria de segurança para prevenir lesões aos utilizadores ou outras pessoas e danos materiais. Por favor leia este manual após compreender o conteúdo abaixo (significados das indicações) e certifique-se de que segue a descrição.



Indicação	Significado da indicação
 AVISO	O texto realçado desta forma indica que o não seguimento das instruções no aviso pode resultar em danos corporais graves (*1) ou perda de vida, se o produto for manuseado incorretamente.
 ATENÇÃO	O texto realçado desta forma indica que o não seguimento das instruções na chamada de atenção pode resultar em ferimentos ligeiros (*2) ou danos (*3) materiais, se o produto for manuseado incorretamente.

*1: Danos corporais graves referem-se a perda de visão, ferimentos, queimaduras, choque elétrico, fraturas ósseas, envenenamento e outros ferimentos que deixam sequelas e requerem hospitalização ou tratamento prolongado em regime de ambulatório.

*2: Ferimentos ligeiros referem-se a ferimentos, queimaduras, choque elétrico e outros ferimentos que não requerem hospitalização ou tratamento prolongado em regime de ambulatório.

*3: Danos materiais referem-se a danos extensos a edifícios, objetos de uso doméstico, animais domésticos e animais de estimação.

	AVISO (Risco de incêndio)	Esta marca é apenas para o refrigerante R32. O tipo de refrigerante está escrito na placa de identificação da unidade exterior. No caso de o tipo de refrigerante ser R32, esta unidade utiliza um refrigerante inflamável. Em caso de fugas do refrigerante e entrar em contacto com o fogo ou peça de aquecimento, poderá criar gás nocivo e existe risco de incêndio.
		Leia cuidadosamente o MANUAL DO PROPRIETÁRIO antes da operação.
		Os técnicos de assistência são obrigados a ler cuidadosamente o MANUAL DO PROPRIETÁRIO e MANUAL DE INSTALAÇÃO antes da operação.
		Estão disponíveis mais informações no MANUAL DO PROPRIETÁRIO, MANUAL DE INSTALAÇÃO e similares.

Indicação de aviso	Descrição		
 <table border="1"> <tr> <td>WARNING</td> </tr> <tr> <td>ELECTRICAL SHOCK HAZARD Disconnect all remote electric power supplies before servicing.</td> </tr> </table>	WARNING	ELECTRICAL SHOCK HAZARD Disconnect all remote electric power supplies before servicing.	AVISO PERIGO DE CHOQUE ELÉCTRICO Desligue todas as fontes de alimentação eléctrica remotas antes de uma operação de assistência.
WARNING			
ELECTRICAL SHOCK HAZARD Disconnect all remote electric power supplies before servicing.			
 <table border="1"> <tr> <td>WARNING</td> </tr> <tr> <td>Moving parts. Do not operate unit with grille removed. Stop the unit before the servicing.</td> </tr> </table>	WARNING	Moving parts. Do not operate unit with grille removed. Stop the unit before the servicing.	AVISO Peças rotativas. Não utilize a unidade com a grelha retirada. Pare a unidade antes de uma operação de assistência.
WARNING			
Moving parts. Do not operate unit with grille removed. Stop the unit before the servicing.			
 <table border="1"> <tr> <td>CAUTION</td> </tr> <tr> <td>Do not touch the aluminum fins of the unit. Doing so may result in injury.</td> </tr> </table>	CAUTION	Do not touch the aluminum fins of the unit. Doing so may result in injury.	ATENÇÃO Não toque nas barbatanas de alumínio da unidade. Caso contrário, poderá ferir-se.
CAUTION			
Do not touch the aluminum fins of the unit. Doing so may result in injury.			

1 Precauções de segurança

O fabricante não assumirá nenhuma responsabilidade por danos causados pela não observação das descrições dadas neste manual.

AVISO

Geral

- Antes de instalar o ar condicionado, leia cuidadosamente o Manual de Instalação e siga as instruções fornecidas para instalar o ar condicionado.
- Apenas um instalador qualificado ou um técnico de assistência qualificado pode efectuar o trabalho de instalação. A instalação incorrecta pode provocar fugas de água, choques eléctricos ou incêndio.
- Não utilize um refrigerante diferente do especificado para complementação ou substituição. Caso contrário, uma pressão anormalmente alta pode ser gerada no ciclo de refrigeração, o que pode resultar numa falha ou explosão do produto ou em ferimentos pessoais.
- Antes de abrir a grelha de entrada da unidade interior ou painel de serviço da unidade exterior, coloque o disjuntor eléctrico na posição DESLIGAR (OFF). A não colocação do disjuntor eléctrico na posição DESLIGAR (OFF) pode provocar choques eléctricos devido ao contacto com as peças internas. Apenas um instalador qualificado (*1) ou um técnico de assistência qualificado (*1) pode retirar a grelha de entrada da unidade interior ou o painel de serviço da unidade exterior e efectuar os trabalhos necessários.
- Antes de efectuar o trabalho de instalação, manutenção, reparação ou de eliminação, coloque o disjuntor eléctrico na posição DESLIGAR (OFF). Caso contrário, podem ocorrer choques eléctricos.
- Coloque um sinal "Trabalho em progresso" junto ao disjuntor eléctrico durante a realização de trabalhos de instalação, manutenção, reparação ou eliminação. Existe um perigo de choques eléctricos se colocar o disjuntor eléctrico na posição LIGAR (ON) por engano.
- Apenas um instalador qualificado (*1) ou um técnico de assistência qualificado (*1) pode efectuar o trabalho em altura com um suporte de 50 cm ou mais, ou retirar a grelha de entrada da unidade interior para efectuar o trabalho.
- Use luvas de protecção e vestuário de trabalho de segurança durante a instalação, a assistência e a eliminação.
- Não toque na barbatana de alumínio da unidade. Pode ferir-se, se o fizer. Se for necessário tocar na palheta por algum motivo, coloque primeiro as luvas de protecção e o vestuário de trabalho de segurança e, em seguida, prossiga.

- Quando trabalhar em altura, utilize uma escada em conformidade com a norma ISO 14122 e efectue o procedimento descrito nas instruções da escada. Use também um capacete industrial como equipamento de protecção para efectuar o trabalho.
- Esta unidade está equipada com um sensor de deteção de fuga de refrigerante para segurança e, para ser eficaz, a unidade deve estar sempre ligada à eletricidade após instalação, exceto durante a manutenção. Desligar o disjuntor faz com que o sensor de deteção de fuga de refrigerante não funcione e não permite a deteção de fuga de refrigerante, provocando um incêndio.
- Não use outro refrigerante que não o R32 ou R410A. Sobre o tipo de refrigerante, verifique a unidade exterior a ser combinada.
- O aparelho de ar condicionado deve ser transportado numa condição estável. Se encontrar qualquer parte do produto quebrada, contacte o seu revendedor.
- Se o aparelho de ar condicionado tiver que ser transportado manualmente, quatro ou mais pessoas devem carregá-lo.
- A manutenção deverá ser executada apenas da forma recomendada pelo fabricante. Há tensão alta no interior da unidade. Pode sofrer um choque eléctrico quando retirar a tampa e a unidade principal.
- Este aparelho destina-se à utilização por parte de especialistas ou utilizadores com formação em oficinas, em indústria ligeira ou para uso comercial por leigos.

Sobre o refrigerante R32

- O aparelho deve ser armazenado num quarto sem fontes de ignição em funcionamento constante (por exemplo: chamas abertas, um aparelho a gás ou um aquecedor eléctrico em funcionamento).
- Não fure nem queime peças do ciclo de refrigerante.
- Não utilize meios para acelerar o processo de descongelamento ou para limpar para além dos recomendados pelo fabricante.
- Tenha presente que os refrigerantes podem não ter qualquer odor.
- A tubagem deve ser protegida contra danos físicos.
- Deve ser observada a conformidade com os regulamentos nacionais de gás.
- Se o sensor de detecção de fuga de refrigerante detectar fuga de refrigerante R32, um ventilador na unidade interna operará automaticamente para movimentar ar na divisão. A agitação do volume do fluxo de ar de cada modelo é mostrada abaixo.

Nome do modelo	Agitação do fluxo de ar (m ³ /h)
RAV-RM561FT*	820
RAV-RM801FT*	930
RAV-RM1101FT*	1 660
RAV-RM1401FT*	1 760
RAV-RM1601FT*	1 760

Seleção do local de instalação

- Quando o aparelho de ar condicionado for instalado em um ambiente pequeno, providencie medidas apropriadas para assegurar que a concentração de fuga do refrigerante que possa ocorrer no ambiente não exceda o nível crítico.
- Não instale num local onde gases inflamáveis possam vazar. Se algum gás vazar e acumular-se ao redor da unidade, o mesmo pode inflamar e causar um incêndio.
- Para transportar o ar condicionado, use sapatos com uma biqueira com protecção adicional.
- Para transportar o ar condicionado, não segure nas faixas existentes à volta da embalagem de cartão. Pode ferir-se, se as faixas se partirem.
- Não coloque nenhum aparelho de combustão num local exposto directamente ao vento do ar condicionado, caso contrário, pode provocar uma combustão imperfeita.
- Quando uma unidade exterior que usa o refrigerante R32 for combinada com uma unidade interior, preste atenção à área do piso da divisão onde vai ser instalada. A unidade não pode ser instalada numa divisão com uma área do piso mais pequena que a área de piso mínima descrita no Apêndice deste Manual de Instalação.

Instalação

- Instale o aparelho de ar condicionado firmemente num lugar onde a base possa suportar o peso adequadamente. Se a força não for suficiente, a unidade pode cair e provocar lesões.
- Siga as instruções fornecidas no Manual de Instalação para instalar o ar condicionado. O incumprimento destas instruções pode provocar a queda do produto ou produzir ruído, vibração, vazamento de água ou outros problemas.
- Realize o trabalho de instalação especificado para a protecção adequada contra a possibilidade de ventos fortes e terremotos. Se o aparelho de ar condicionado não for instalado adequadamente, uma unidade pode tombar ou cair, provocando um acidente.
- Se o gás refrigerante vazar durante o trabalho de instalação, ventile o ambiente imediatamente. Se o gás refrigerante que escapou entrar em contacto com fogo, poderá dar origem a gás tóxico, que poderá incendiar-se.
- Utilize uma empilhadora para transportar as unidades do aparelho de ar condicionado e utilize um guincho ou guindaste para sua instalação.
- A instalação de tubagens deve ser reduzida ao mínimo.

Tubagem do refrigerante

- Instale correctamente o tubo de refrigeração durante a instalação antes de colocar o ar condicionado em funcionamento. Se operar o compressor com a válvula aberta e sem o tubo de refrigerante, o compressor aspira ar e o ciclo de refrigeração é sobrepressurizado, o que poderá provocar uma lesão.
- Aperte a porca de alargamento com uma chave dinamométrica e da forma especificada. O aperto excessivo da porca de alargamento pode provocar uma racha na porca de alargamento após um longo período, que pode resultar na fuga de refrigerante.
- Após o trabalho de instalação, confirme que não haja nenhuma fuga do gás refrigerante. Se houver uma fuga de gás refrigerante para o compartimento que entre em contacto com uma chama, por exemplo, no caso de um fogão, poderá gerar gás tóxico, que pode incendiar-se.
- Quando instalar ou mudar o ar condicionado, siga as instruções fornecidas no Manual de Instalação e elimine o ar completamente para que nenhum gás para além do refrigerante seja misturado no ciclo de refrigeração. A não eliminação completa do ar pode provocar uma avaria no ar condicionado.
- Tem de utilizar gás de nitrogénio para o teste de impermeabilidade.
- Tem de ligar o tubo de carga para que não exista nenhuma folga.

Cablagem eléctrica

- Apenas um instalador qualificado (*1) ou um técnico de assistência qualificado (*1) pode efectuar o trabalho eléctrico do ar condicionado. Este trabalho não deve ser efectuado por uma pessoa não qualificada em nenhuma circunstância porque um trabalho executado incorrectamente pode resultar em choques eléctricos e/ou fugas eléctricas.
- Para conectar os cabos eléctricos, reparar peças eléctricas ou efectuar outros trabalhos eléctricos, utilize luvas de proteção de electricista, sapatos isoladores e vestuário para proteção contra choques eléctricos. A não utilização deste equipamento de proteção pode resultar em choques eléctricos.
- Utilize cablagens que cumpram as especificações fornecidas no Manual de Instalação e as condições nas leis e regulamentos locais. A utilização de cablagens que não cumpram as especificações pode originar choques eléctricos, fugas eléctricas, fumo e/ou um incêndio.
- Ligue o cabo de terra. (Trabalho de ligação à terra)
Uma ligação à terra incompleta pode causar choque eléctrico.
- Não ligue os cabos de terra a tubos de gás, tubos de água, pára-raios ou fios de terra de telefone.
- Depois de concluir o trabalho de reparação ou mudança, verifique se os fios de terra estão ligados correctamente.
- Instale um disjuntor eléctrico que cumpra as especificações fornecidas no manual de instalação e as condições nas leis e regulamentos locais.
- Instale o disjuntor eléctrico num local de fácil acesso ao agente.
- Quando instalar um disjuntor eléctrico no exterior, instale um disjuntor concebido para utilizar no exterior.
- O cabo de fornecimento de energia ou o cabo de conexão da unidade interior e exterior não devem ser conectados no meio sob nenhuma circunstância (Conexão usando um terminal sem solda etc.)
O problema da ligação em locais em que o cabo é conectado no meio pode originar fumo e/ou um incêndio.
- O trabalho de ligação de cabos e fios eléctricos deve ser feito em conformidade com as leis e regulamentos da comunidade em questão e com o manual de instalação.
Se assim não for, o resultado pode ser electrocussão ou curto-circuito.
- Verifique que a cablagem não estará sujeita a desgaste, corrosão, pressão excessiva, vibração, extremidades afiadas ou qualquer outro efeito ambiental adverso. Deve também ter em conta os efeitos do decorrer do tempo ou da vibração contínua proveniente de fontes como compressores ou ventoinhas.

Teste de funcionamento

- Antes de utilizar o ar condicionado após a conclusão do trabalho, verifique se a tampa da caixa do equipamento eléctrico da unidade interior e o painel de serviço da unidade exterior estão fechados e coloque o disjuntor eléctrico na posição LIGAR (ON). Pode sofrer um choque eléctrico se ligar a corrente eléctrica sem efectuar primeiro estas verificações.
- Quando detetar algum tipo de problema (como, por exemplo, quando aparecer uma indicação de erro, cheiro a queimado, sons anormais, o ar condicionado não arrefecer ou aquecer, ou existir uma fuga de água) no aparelho de ar condicionado, não toque no ar condicionado, mas coloque o disjuntor eléctrico na posição DESLIGAR (OFF) e contacte um técnico de assistência qualificado. Tome as medidas necessárias para garantir que a corrente eléctrica não será ligada (através da colocação do aviso “fora de serviço” junto ao disjuntor de serviço, por exemplo) até chegar o técnico de assistência qualificado. Se continuar a utilizar o ar condicionado com problemas, pode aumentar a ocorrência de problemas mecânicos e provocar choques eléctricos ou outros problemas.
- Depois de terminar o trabalho, certifique-se de que utiliza um aparelho de verificação do isolamento (500 VMΩ) para verificar se a resistência é 1 MΩ ou mais entre a secção de carga e a secção metálica sem carga (Secção de ligação à terra). Se o valor da resistência for baixo, ocorre uma fuga ou um choque eléctrico no lado do utilizador.
- Depois de concluir o trabalho de instalação, verifique se existem fugas de refrigerante, a resistência do isolamento e a drenagem de água. Realize um teste para verificar se o ar condicionado está a funcionar correctamente.

Explicações fornecidas ao utilizador

- Depois de concluir o trabalho de instalação, indique o local de instalação do disjuntor eléctrico ao utilizador. Se o utilizador não souber a localização do disjuntor eléctrico, não será capaz de o desligar no caso de ocorrer um problema no ar condicionado.
- Após a instalação, consulte o Manual do proprietário para explicar ao cliente como utilizar e fazer a manutenção da unidade.

Mudança

- Apenas um instalador qualificado (*1) ou um técnico de assistência qualificado (*1) pode mudar o ar condicionado. É perigoso o ar condicionado ser mudado por uma pessoa não qualificada porque pode ocorrer um incêndio, choques eléctricos, lesões, fugas de água, ruídos e/ou vibrações.
- Quando efectuar o trabalho de bombagem, encerre o compressor antes de desligar o tubo de refrigerante. Se desligar o tubo do refrigerante com a válvula de serviço ainda aberta e o compressor ainda em funcionamento, faz com que o ar ou outros gases sejam aspirados, aumentando a pressão interna do ciclo de refrigeração para um nível anormalmente elevado, podendo causar a rutura, lesões ou outros problemas.

(*1) Consulte "Definição de Instalador Qualificado ou de Técnico de Assistência Qualificado".

ATENÇÃO

Este ar condicionado adotou um refrigerante HFC (R32 ou R410A) que não destrói a camada de ozono.

- Como o refrigerante R32 ou R410A é facilmente afetado por impurezas, como humidade, película oxidada, óleo, etc., devido à alta pressão, tenha cuidado para não permitir que humidade, sujidade, refrigerante existente, óleo da máquina de refrigeração, etc. se misturem no ciclo de refrigeração durante o trabalho de instalação.
- É necessária uma ferramenta especial para o refrigerante R32 ou R410A para a instalação.
- Use materiais de tubulação para o tubo de conexão novos e limpos, de modo que a humidade e sujidade não se misturem durante o trabalho de instalação.
- Quando usar tubos existentes, siga o manual de instalação fornecido com a unidade exterior.
- Tenha cuidado com o funcionamento do ventilador quando o disjuntor for ligado. Se o sensor de detecção de fuga de refrigerante detectar uma fuga de refrigerante, o ventilador roda automaticamente mesmo quando o ar condicionado para. Tenha cuidado para não ser ferido pelo ventilador.

Hartelijk dank voor uw aankoop van deze Toshiba-airconditioner.

Lees deze instructies aandachtig door, inclusief belangrijke informatie overeenkomstig de vereisten van de "Machinerichtlijn" (Richtlijn 2006/42/EG), en zorg dat u alles volledig begrijpt.

Na het doorlezen van deze instructies dient u ze te bewaren op een veilige plaats, samen met de eigenaarshandleiding en de installatiehandleiding die bij uw product zijn geleverd.

Algemene benaming: Airconditioner

Definitie van bevoegd installateur of bevoegd onderhoudsmonteur

De airconditioner moet worden geïnstalleerd, onderhouden, gerepareerd en uiteindelijk weggedaan door een bevoegd installateur of bevoegd onderhoudsmonteur. Wanneer een van deze taken verricht moet worden, verzoekt u dan een bevoegd installateur of bevoegd onderhoudsmonteur om dit voor u te doen.

Een bevoegd installateur of bevoegd onderhoudsmonteur is een persoon die beschikt over de kennis en bevoegdheden die staan vermeld in de onderstaande tabel.

Persoon	Kennis en bevoegdheden waarover de persoon moet beschikken
Bevoegd installateur	<ul style="list-style-type: none"> De bevoegde installateur is een persoon die door Toshiba Carrier Corporation gemaakte airconditioners installeert, onderhoudt, verplaatst en verwijderd. Hij of zij is opgeleid om door Toshiba Carrier Corporation gemaakte airconditioners te installeren, onderhouden, verplaatsen en te verwijderen. Deze persoon kan ook iemand zijn die in dergelijke taken is geïnstrueerd door een persoon of personen die zijn opgeleid en is dus goed op de hoogte van de kennis voor deze taken. De bevoegde installateur die bevoegd is om het elektrische gedeelte van de installatie, verplaatsing en verwijdering op zich te nemen beschikt over de kwalificaties voor deze elektrische werkzaamheden zoals voorzien in plaatselijke wetten en regelgeving. Deze persoon is opgeleid voor koel- en leidingenwerkzaamheden aan de airconditioners gemaakt door Toshiba Carrier Corporation. Deze persoon kan ook iemand zijn die in dergelijke taken is geïnstrueerd door een persoon of personen die zijn opgeleid en is dus goed op de hoogte van de kennis voor dit soort werk. De bevoegde installateur die bevoegd is om het koel- en leidingenwerk van de installatie, verplaatsing en verwijdering op zich te nemen beschikt over de kwalificaties voor deze koel- en leidingenwerkzaamheden zoals voorzien in plaatselijke wetten en regelgeving. Deze persoon is opgeleid voor koel- en leidingenwerkzaamheden aan de airconditioners gemaakt door Toshiba Carrier Corporation. Deze persoon kan ook iemand zijn die in dergelijke taken is geïnstrueerd door een persoon of personen die zijn opgeleid en is dus goed op de hoogte van de kennis voor dit soort werk. De bevoegde installateur die bevoegd is om op hoogte te werken is opgeleid om op hoogten te werken met airconditioners gemaakt door Toshiba Carrier Corporation. Deze persoon kan ook iemand zijn die in dergelijke taken is geïnstrueerd door een persoon of personen die zijn opgeleid en is dus goed op de hoogte van de kennis voor dit soort werk.
Bevoegd onderhoudsmonteur	<ul style="list-style-type: none"> De bevoegde onderhoudspersoon is een persoon die door Toshiba Carrier Corporation gemaakte airconditioners installeert, repareert, onderhoudt, verplaatst en verwijderd. Hij of zij is opgeleid om door Toshiba Carrier Corporation gemaakte airconditioners te installeren, repareren, onderhouden, verplaatsen en te verwijderen. Deze persoon kan ook iemand zijn die in dergelijke taken is geïnstrueerd door een persoon of personen die zijn opgeleid en is dus goed op de hoogte van de kennis voor deze taken. De bevoegde onderhoudspersoon die bevoegd is om het elektrische gedeelte van de installatie, reparatie, verplaatsing en verwijdering op zich te nemen beschikt over de kwalificaties voor deze elektrische werkzaamheden zoals voorzien in plaatselijke wetten en regelgeving. Deze persoon is opgeleid voor werkzaamheden aan het elektrische systeem van de airconditioners gemaakt door Toshiba Carrier Corporation. Deze persoon kan ook iemand zijn die in dergelijke taken is geïnstrueerd door een persoon of personen die zijn opgeleid en is dus goed op de hoogte van de kennis voor dit soort werk. De bevoegde installateur die bevoegd is om het koel- en leidingenwerk van de installatie, reparatie, verplaatsing en verwijdering op zich te nemen beschikt over de kwalificaties voor deze koel- en leidingenwerkzaamheden zoals voorzien in plaatselijke wetten en regelgeving. Deze persoon is opgeleid voor koel- en leidingenwerkzaamheden aan de airconditioners gemaakt door Toshiba Carrier Corporation. Deze persoon kan ook iemand zijn die in dergelijke taken is geïnstrueerd door een persoon of personen die zijn opgeleid en is dus goed op de hoogte van de kennis voor dit soort werk. De bevoegde onderhoudspersoon die bevoegd is om op hoogte te werken is opgeleid om op hoogten te werken met airconditioners gemaakt door Toshiba Carrier Corporation. Deze persoon kan ook iemand zijn die in dergelijke taken is geïnstrueerd door een persoon of personen die zijn opgeleid en is dus goed op de hoogte van de kennis voor dit soort werk.

Definitie van beschermende kleding

Wanneer de airconditioner wordt vervoerd, geïnstalleerd, onderhouden, gerepareerd of verwijderd, moet u beschermende werkhandschoenen en veiligheidskleding dragen.

Naast dergelijke normale veiligheidswerkklleding dient u de hieronder beschreven speciale beschermende kleding te dragen voor de werkzaamheden vermeld in de onderstaande tabel.

Werken aan de apparatuur zonder beschermende kleding te dragen is gevaarlijk, omdat u kwetsbaarder bent voor verwondingen, elektrische schokken, brandwonden en ander letsel.

Te verrichten werkzaamheden	Beschermende kleding
Alle soorten werk	Werkhandschoenen Veiligheidswerkklleding
Elektrische werkzaamheden	Kleding die bescherming biedt tegen elektrische schokken Isolerende schoenen Handschoenen die bescherming bieden tegen elektrische schokken
Werk uitgevoerd op hoogte (50 cm of meer)	Veiligheidshelm voor industrieel gebruik
Vervoer van zware voorwerpen	Schoenen met stalen neuzen
Reparatie van buiteneenheden	Handschoenen die bescherming bieden tegen elektrische schokken

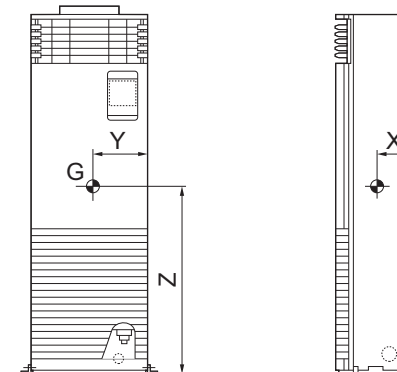

Zwaartepunt

Model	X (mm)	Y (mm)	Z (mm)
RAV-RM561FT-EN/ES	85	285	820
RAV-RM801FT-EN/ES			
RAV-RM1101FT-EN/ES	195	290	860
RAV-RM1401FT-EN/ES			
RAV-RM1601FT-EN/ES			



■ Waarschuwingen op de airconditioner

In deze veiligheidsvoorzorgsmaatregelen worden belangrijke punten beschreven met betrekking tot veiligheid om letsel bij gebruikers of andere personen en schade aan eigendommen te voorkomen. Lees deze handleiding door nadat u de onderstaande informatie (betekenissen van aanduidingen) hebt begrepen en houd u altijd aan de beschrijving.



Aanduiding	Betekenis aanduiding
 WAARSCHUWING	Tekst die op deze manier wordt aangeduid, geeft aan dat het niet voldoen aan de instructies in de waarschuwing kan leiden tot ernstig lichamelijk letsel (*1) of overlijden als onjuist wordt omgegaan met het product.
 LET OP	Tekst die op deze manier wordt aangeduid, geeft aan dat het niet voldoen aan de instructies in de waarschuwing kan leiden tot licht lichamelijk letsel (*2) of schade (*3) aan eigendommen als onjuist wordt omgegaan met het product.

*1: Met ernstig lichamelijk letsel worden blindheid, letsel, brandwonden, elektrische schokken, botbreuken, vergiftiging en andere verwondingen met na-effecten bedoeld waarbij ziekenhuisopname of langdurige behandeling als externe patiënt is vereist.

*2: Met licht letsel worden letsel, brandwonden, elektrische schokken en andere verwondingen bedoeld waarbij ziekenhuisopname of langdurige behandeling als externe patiënt niet nodig is.

*3: Met schade aan eigendommen wordt schade aan gebouwen, huisraad, vee en huisdieren bedoeld.

	WAARSCHUWING (Brandrisico)	Deze markering geldt uitsluitend voor het koelmiddel R32. Het type koelmiddel staat vermeld op de naamplaat van de buiteneenheid. In geval dat het type koelmiddel R32 is, maakt deze eenheid gebruik van een brandbaar koelmiddel. Als er koelmiddel lekt en in aanraking komt met vuur of een verwarmingsonderdeel, creëert dit schadelijk gas en bestaat er een brandrisico.
		Lees de GEBRUIKERSHANDLEIDING zorgvuldig door voorafgaand aan gebruik.
		Onderhoudspersoneel dient de GEBRUIKERSHANDLEIDING en de INSTALLATIEHANDLEIDING voorafgaand aan gebruik zorgvuldig door te lezen.
		Meer informatie is beschikbaar in de GEBRUIKERSHANDLEIDING, de INSTALLATIEHANDLEIDING en dergelijke.

Waarschuwingaanduiding	Beschrijving		
 <table border="1"> <tr> <td>WARNING</td> </tr> <tr> <td>ELECTRICAL SHOCK HAZARD Disconnect all remote electric power supplies before servicing.</td> </tr> </table>	WARNING	ELECTRICAL SHOCK HAZARD Disconnect all remote electric power supplies before servicing.	WAARSCHUWING GEVAAR VOOR ELEKTRISCHE SCHOK Verbreek alle externe stroomvoorzieningsaansluitingen alvorens enig onderhoud te verrichten.
WARNING			
ELECTRICAL SHOCK HAZARD Disconnect all remote electric power supplies before servicing.			
 <table border="1"> <tr> <td>WARNING</td> </tr> <tr> <td>Moving parts. Do not operate unit with grille removed. Stop the unit before the servicing.</td> </tr> </table>	WARNING	Moving parts. Do not operate unit with grille removed. Stop the unit before the servicing.	WAARSCHUWING Bewegende delen. Schakel het apparaat niet in wanneer het voorrooster is verwijderd. Stop de werking van de unit alvorens enig onderhoud te verrichten.
WARNING			
Moving parts. Do not operate unit with grille removed. Stop the unit before the servicing.			
 <table border="1"> <tr> <td>CAUTION</td> </tr> <tr> <td>Do not touch the aluminum fins of the unit. Doing so may result in injury.</td> </tr> </table>	CAUTION	Do not touch the aluminum fins of the unit. Doing so may result in injury.	LET OP De aluminium vinnen van de unit niet aanraken. Dat zou tot ernstige verwondingen kunnen leiden.
CAUTION			
Do not touch the aluminum fins of the unit. Doing so may result in injury.			

1 Voorzorgen voor de veiligheid

De fabrikant is niet aansprakelijk voor schade ten gevolge van het niet opvolgen van aanwijzingen in deze handleiding.

WAARSCHUWING

Algemeen

- Alvorens u begint met het installeren van de airconditioner, moet u de installatiehandleiding aandachtig doorlezen. Volg alle instructies voor het installeren van de airconditioner op.
- Het installeren mag alleen door een bevoegde installateur of onderhoudsmonteur worden uitgevoerd. Een foute installatie resulteert mogelijk in waterlekkage, elektrische schokken of brand.
- Gebruik voor het bijvullen of vervangen geen ander koelmiddel dan het gespecificeerde middel. Er wordt anders namelijk mogelijk abnormaal hoge druk in de koelcyclus opgebouwd met een onjuiste werking, ontploffing of lichamelijk letsel als gevolg.
- Voordat u het inlaatrooster van de binnenunit of het onderhoudspaneel van de buitenunit opent, zet u eerst de stroomonderbreker in de OFF (UIT)-stand. Als u verzuimt de stroomonderbreker in de OFF (UIT)-stand te zetten, loopt u de kans op een elektrische schok bij aanraken van de inwendige onderdelen. Alleen een bevoegd installateur (*1) of een bevoegd onderhoudsmonteur (*1) mag het inlaatrooster van de binnenunit of het onderhoudspaneel van de buitenunit verwijderen en het vereiste werk verrichten.
- Alvorens u begint met installeren, onderhouden, repareren of verwijderen, zet u eerst de schakelaar in de OFF (UIT)-stand. Anders kan dit tot elektrische schokken leiden.
- Plaats tijdens het installeren, onderhouden, repareren of verwijderen van het apparaat een bordje “werk in uitvoering” bij de schakelaar. Als de schakelaar per vergissing in de ON (AAN)-stand staat, loopt u kans op een elektrische schok.
- Alleen een bevoegd installateur (*1) of een bevoegd onderhoudsmonteur (*1) mag werkzaamheden op hoogte verrichten met een trapje van 50 cm of meer, of het inlaatrooster van de binnenunit verwijderen om werk te verrichten.
- Draag tijdens het installeren, onderhouden en verwijderen van het apparaat altijd werkhandschoenen en veiligheidskleding.
- Raak de aluminium vinnen van de unit niet aan. Anders kunt u zich eraan verwonden. Als het nodig is de vin aan te raken, trekt u eerst werkhandschoenen en beschermende kleding aan en begint u dan pas met het werk.

- Gebruik voor het werken op hoogte een ladder die voldoet aan de ISO 14122-norm en volg de aanwijzingen in de handleiding van de ladder. Draag als beschermingsmiddel ook een helm voor gebruik in de industrie om het werk uit te voeren.
- Dit apparaat is voor de veiligheid uitgerust met een detectiesensor voor koelmiddellekken, maar om effectief te zijn, moet het apparaat ten allen tijden na installatie ingeschakeld blijven, behalve tijdens onderhoud. Het uitschakelen van de stroomonderbreker zorgt ervoor dat de detectiesensor voor koelmiddellekken niet werkt, en deze sensor is dan niet in staat om een koelmiddellek te detecteren wat kan resulteren in brand.
- Gebruik geen ander koelmiddel dan R32 of R410A. Voor het koelmiddelttype controleert u de te combineren buitenunit.
- De airconditioner moet stabiel worden getransporteerd. Neem contact op met de dealer, indien onderdelen beschadigd zijn.
- Draag de airconditioner altijd met minimaal 4 personen indien deze met de hand moet worden verplaatst.
- Onderhoud mag uitsluitend worden uitgevoerd volgens de aanbevelingen van de fabrikant. U kunt bij het verwijderen van het deksel en de hoofdunit een elektrische schok krijgen.
- Dit toestel moet worden gebruikt door experts of opgeleide gebruikers in winkels, de lichte industrie of voor commercieel gebruik door leken.

Informatie over het koelmiddel R32

- Het apparaat moet worden bewaard in een ruimte die vrij is van continu werkende ontstekingsbronnen (bijvoorbeeld: open vuur, een werkend gastoestel of een werkende elektrische verwarming).
- Zorg dat er geen onderdelen van de koelmiddelcyclus worden doorboord of verbrand.
- Gebruik geen middelen om het ontdooiproces te versnellen of om te reinigen, behalve die worden aanbevolen door de fabrikant.
- Houd er rekening mee dat koelmiddelen geurloos kunnen zijn.
- Leidingwerk moet worden beschermd tegen fysieke schade.
- De nationale regelgeving omtrent gas dient in acht te worden genomen.
- Als de koelmiddellekdetectiesensor een lek van koelmiddel R32 ontdekt, wordt de ventilator van de binnenunit automatisch ingeschakeld om de ruimte te ventileren. Volume van de luchtstroom voor elk model wordt hieronder getoond.

Model	Ventilatieluchtstroom (m ³ /h)
RAV-RM561FT*	820
RAV-RM801FT*	930
RAV-RM1101FT*	1 660
RAV-RM1401FT*	1 760
RAV-RM1601FT*	1 760

Keuze van de installatieplaats

- Indien de airconditioner in een kleine ruimte wordt geplaatst, neem dan de nodige maatregelen om te verzekeren dat de concentratie van lekkend koelmiddel in de ruimte de limiet niet kan overschrijden.
- Installeer niet op plaatsen waar ontvlambaar gas kan lekken. Als gas lekt en zich rond de unit ophoopt, kan het ontvlammen en brand veroorzaken.
- Bij het vervoeren van de airconditioner dient u veiligheidsschoenen te dragen.
- Bij het vervoeren van de airconditioner mag u deze niet optillen aan de banden rond de verpakkingendoos. U kunt zichzelf kwetsen, mochten de banden breken.
- Zet geen verbrandingsapparaat op een plaats waar het in de directe luchtstroom van de airconditioner staat. Anders vindt mogelijk onvolledige verbranding plaats.
- Wanneer een buitenunit die R32-koelmiddel gebruikt wordt gecombineerd met een binnenunit, let dan op het vloeroppervlak van de ruimte waarin deze moet worden geïnstalleerd. De unit kan niet worden geïnstalleerd in een ruimte met een vloeroppervlak die kleiner is dan het minimale vloeroppervlak dat staat beschreven in de bijlage van deze installatiehandleiding.

Installatie

- Installeer de airconditioner op een plaats die stevig genoeg is voor het gewicht van de unit. Als dat niet het geval is, kan het apparaat vallen en letsels veroorzaken.
- Volg de instructies in de installatiehandleiding bij het installeren van de airconditioner. Indien u de instructies niet opvolgt, kan de unit vallen of kantelen of kunnen extra ruis, trillingen, waterlekage en andere problemen ontstaan.
- Voer de vereiste installatiewerkzaamheden uit ter bescherming tegen wind, storm en aardbevingen. De airconditioner kan vallen of kantelen en zo ernstige ongelukken veroorzaken, indien deze fout is geïnstalleerd.
- Ventileer de ruimte direct, indien er tijdens het installeren koelmiddel lekt. Wanneer het gelekte koelgas in contact komt met vuur, kunnen er giftige gassen ontstaan die kunnen ontbranden.
- Gebruik een vorkheftruck voor het verplaatsen van de airconditioner-units en een takel of dergelijk geschikt voorwerp voor het installeren.
- De installatie van leidingen moet tot een minimum worden gehouden.

Koelmiddelleiding

- Monteer tijdens de installatiewerkzaamheden de koelmiddelleiding nauwkeurig voordat de airconditioner wordt bediend. Als de compressor wordt bediend met de klep open en zonder koelmiddelbuis, zuigt de compressor lucht aan en ontstaat er overdruk in het koelsysteem, hetgeen kan leiden tot verwondingen.
- Draai de flensmoer met een momentsleutel op de voorgeschreven manier aan. Als de flensmoer te krachtig wordt aangedraaid, kan de moer een tijd later barsten, waardoor koelmiddel kan gaan lekken.
- Controleer na het installeren dat er geen koelmiddel lekt. Wanneer er koelgas in de ruimte lekt en naar een bron van vuur stroomt, zoals een gasfornuis, kunnen er giftige gassen ontstaan die zouden kunnen ontbranden.
- Na het installeren of verplaatsen van de airconditioner volgt u de aanwijzingen in de installatiehandleiding voor het volledig ontluichten van de leidingen, zodat er in het koelsysteem geen ander gas overblijft dan alleen het koelmiddel. Bij onvolledig ontluichten kan de airconditioner niet goed functioneren.
- Gebruik stikstofgas voor de test op luchtdichtheid.
- De oplaadslang moet zo worden aangesloten dat deze niet slap hangt.

Elektrische bedrading

- Alleen een bevoegd installateur (*1) of een bevoegd onderhoudsmonteur (*1) mag elektrische werkzaamheden aan de airconditioner verrichten. Onder geen voorwaarde mag dit werk worden verricht door een onbevoegde, aangezien fouten of vergissingen kunnen leiden tot elektrische schokken en/of kortsluiting of lekstroom.
- Bij het aansluiten van de stroomdraden, het repareren van elektrische onderdelen of het verrichten van andere elektrische werkzaamheden dient u handschoenen te dragen ter bescherming tegen elektrische stroom en isolerend schoeisel en kleding ter bescherming tegen elektrische schokken. Als u dergelijke beschermende kleding niet draagt, loopt u de kans op elektrische schokken.
- Gebruik bedrading die voldoet aan de specificaties in de installatiehandleiding en de ter plaatse geldende voorschriften en wetten. Het gebruik van bedrading die niet voldoet aan de specificaties kan resulteren in elektrische schokken, kortsluiting en lekstroom, rookontwikkeling en/of brandgevaar.
- Verbind een aardendraad. (aardaansluitingen)
Een onvolledige aarding kan een elektrische schok veroorzaken.
- Sluit aarddraden niet aan op gasleidingen, waterleidingen, bliksemafleiders of aardkabels voor telefoons.
- Na het voltooiën van de verplaatsing of het reparatiewerk dient u te controleren of de aardleidingen naar behoren zijn aangesloten.
- Installeer een stroomonderbreker die voldoet aan de specificaties in de installatiehandleiding en de ter plaatse geldende voorschriften en wetten.
- Installeer de stroomonderbreker op een plaats waar die goed toegankelijk is voor de gebruiker.
- Als u de stroomonderbreker buitenshuis aanbrengt, let dan goed op dat het een specifiek voor buitengebruik geschikt type is.
- In geen geval moet de voedingsdraad of de binnen- en buitenverbindingenkabel in het midden worden aangesloten (verbinding met behulp van soldeervrije aansluiting, enz.)
Aansluitprobleem op de plaatsen waar de kabel in het midden is aangesloten, kan tot rookontwikkeling en/of brandgevaar leiden.
- Werkzaamheden met elektrische bedrading moeten altijd worden uitgevoerd in overeenstemming met de plaatselijke regelgeving, wetten en de installatiehandleiding.
Doet u dit niet, dan kan dat leiden tot elektrocutie of kortsluiting.
- Controleer of de bedrading geen slijtage, corrosie, overdruk, trillingen, scherpe randen of andere nadelige effecten toont. Houd bij de controle ook rekening met de effecten van veroudering of continue trillingen door bronnen zoals compressoren en ventilators.

Testen

- Nadat u de werkzaamheden hebt voltooid dient u voor het inschakelen van de airconditioner eerst te controleren of het deksel van de elektriciteitskast van de binneneenheid en het onderhoudspaneel van de buiteneenheid zijn gesloten, om vervolgens de stroomonderbreker in de ON (AAN)-stand te zetten. Als u de stroom inschakelt zonder eerst deze punten te controleren, kunt u een elektrische schok krijgen.
- Indien er iets mis is met de airconditioner (wanneer u een foutmelding ziet of een brandlucht ruikt, vreemde geluiden hoort of wanneer de airconditioner niet koelt of verwarmt, of wanneer er water uit lekt), raak dan de airconditioner niet aan, maar zet de schakelaar in de OFF (UIT)-stand en neem contact op met een bevoegd onderhoudsmonteur. Neem de nodige maatregelen om te voorkomen dat de stroom wordt ingeschakeld (breng bijvoorbeeld een bordje "defect" aan dicht bij de stroomonderbreker) totdat de bevoegde onderhoudsmonteur arriveert. Het voortzetten van het gebruik van de airconditioner terwijl er iets mis mee is, kan leiden tot ernstige mechanische defecten, elektrische schokken en andere problemen.
- Nadat het werk is voltooid, dient u met een isolatietester (500 VMΩ) te controleren of de weerstand 1 MΩ of meer bedraagt tussen de stroomvoerende delen en het niet-stroomvoerende metalen deel (aardingsdeel). Als de weerstandswaarde te gering is, kan er kortsluiting, lekstroom of een elektrische schok optreden aan de gebruikerskant.
- Na voltooiing van het installatiewerk controleert u of er geen koelmiddel lekt, of de waterafvoer in orde is en controleert u de weerstand van de isolatie. Vervolgens laat u de airconditioner proefdraaien, om te zien of het apparaat goed werkt.

Uitleg aan de gebruiker

- Na voltooiing van het installatiewerk vertelt u de gebruiker waar de stroomonderbreker zich bevindt. Als de gebruiker niet weet waar de stroomonderbreker zit, kan hij of zij de airconditioner niet uitschakelen wanneer er zich een storing voordoet in de werking.
- Als de installatie is voltooid, volg dan de Gebruikershandleiding om de klant uit te leggen hoe hij het apparaat moet gebruiken en onderhouden.

Elders opstellen

- Alleen een bevoegd installateur (*1) of een bevoegd onderhoudsmonteur (*1) mag de airconditioner verplaatsen. Het is gevaarlijk als een onbevoegde de airconditioner verplaatst, aangezien dat kan leiden tot gevaar voor brand, elektrische schokken, verwondingen, waterlekage, bijgeluiden en/of trillingen.
- Bij uitvoeren van werkzaamheden wanneer de pomp gestopt is, schakelt u eerst de compressor uit voordat u de koelmiddelbuis losmaakt. Wanneer u de koelmiddelleiding loskoppelt met de onderhoudsklep open en de compressor in bedrijf, wordt lucht en gas opgezogen waardoor de druk binnen de koelcyclus te hoog oploopt, wat mogelijk kan leiden tot barsten, letsel of andere problemen.

(*1) Zie "Definitie van bevoegd installateur of bevoegd onderhoudsmonteur".

LET OP

Deze airconditioner werkt met het HFC-koelmiddel (R32 of R410A) dat de ozonlaag niet aantast.

- Aangezien het R32- of R410A-koelmiddel gemakkelijk wordt beïnvloed door verontreinigingen zoals vocht, geoxideerde film, olie, enz., vanwege de hoge druk, moet u ervoor zorgen dat vocht, vuil, bestaand koelmiddel, koelmachineolie, enz. niet vermengd raken in de koelcyclus tijdens de installatiewerkzaamheden.
- Voor de installatie is een speciaal gereedschap voor het R32- of R410A-koelmiddel vereist.
- Gebruik nieuw en schoon leidingmateriaal voor de verbindingspijp zodat vocht en vuil tijdens de installatiewerkzaamheden niet met elkaar worden vermengd.
- Wanneer u bestaande leidingen gebruikt, volg dan de installatiehandleiding die bij de buitenunit is geleverd.
- Wees voorzichtig wanneer de ventilator in werking is als de stroomonderbreker is ingeschakeld. Als de koelmiddellekdetectiesensor een koelmiddellek detecteert, draait de ventilator automatisch, zelfs wanneer de airconditioner stopt. Zorg dat u zich niet aan de ventilator verwondt.

Σας ευχαριστούμε για την αγορά αυτού του κλιματιστικού Toshiba.

Παρακαλούμε διαβάστε με προσοχή αυτές τις οδηγίες, οι οποίες περιλαμβάνουν σημαντικές πληροφορίες που συμμορφώνονται με την "Οδηγία περί Μηχανημάτων" (Οδηγία 2006/42/ΕΚ), και βεβαιωθείτε ότι τις κατανοήσατε. Όταν διαβάσετε αυτές τις οδηγίες, φροντίστε να τις φυλάξετε σε ασφαλές μέρος μαζί με το Εγχειρίδιο Χρήσης και το Εγχειρίδιο Εγκατάστασης τα οποία παρέχονται με το προϊόν σας.

Γενικός Χαρακτηρισμός: Κλιματιστική μονάδα

Ορισμός Εξειδικευμένου Εγκαταστάτη ή Εξειδικευμένου Τεχνικού Σέρβις

Απαιτείται εγκατάσταση, συντήρηση, επισκευή και απόρριψη του κλιματιστικού από εξειδικευμένο εγκαταστάτη ή εξειδικευμένο τεχνικό σέρβις. Όταν απαιτείται εκτέλεση οποιασδήποτε από τις συγκεκριμένες εργασίες, αναθέστε την εκτέλεσή της σε εξειδικευμένο εγκαταστάτη ή εξειδικευμένο τεχνικό σέρβις.

Ένας εξειδικευμένος εγκαταστάτης ή εξειδικευμένος τεχνικός σέρβις είναι αντιπρόσωπος ο οποίος διαθέτει τα προσόντα και τις γνώσεις που περιγράφονται στον πίνακα κατωτέρω.

Αντιπρόσωπος	Προσόντα και γνώσεις τα οποία απαιτείται να διαθέτει ο αντιπρόσωπος
Εξειδικευμένος εγκαταστάτης	<ul style="list-style-type: none"> Ο εξειδικευμένος εγκαταστάτης είναι ένα άτομο που πραγματοποιεί εργασίες εγκατάστασης, συντήρησης, αλλαγής θέσης και αφαίρεσης των κλιματιστικών που κατασκευάζει η Toshiba Carrier Corporation. Το άτομο αυτό έχει εκπαιδευτεί στην εγκατάσταση, συντήρηση, αλλαγή θέσης και αφαίρεση των κλιματιστικών που κατασκευάζει η Toshiba Carrier Corporation ή, εναλλακτικά, έχει διδαχθεί αυτές τις εργασίες από άτομα που έχουν εκπαιδευτεί και είναι επομένως πλήρως εξοικειωμένοι με τις γνώσεις που σχετίζονται με αυτές τις εργασίες. Ο εξειδικευμένος εγκαταστάτης που επιτρέπεται να κάνει τις ηλεκτρικές εργασίες που σχετίζονται με την εγκατάσταση, αλλαγή θέσης και αφαίρεση, διαθέτει τα προσόντα που σχετίζονται με αυτές τις ηλεκτρικές εργασίες όπως ορίζεται από τους τοπικούς νόμους και κανονισμούς, και είναι άτομο που έχει εκπαιδευτεί σε θέματα που σχετίζονται με τις ηλεκτρικές εργασίες σε κλιματιστικά που κατασκευάζονται από την Toshiba Carrier Corporation ή, εναλλακτικά, έχει διδαχθεί αυτές τις εργασίες από άτομα που έχουν εκπαιδευτεί και, επομένως, είναι πλήρως εξοικειωμένοι με τις γνώσεις που σχετίζονται με αυτές τις εργασίες. Ο εξειδικευμένος εγκαταστάτης που επιτρέπεται να χειρίζεται το ψυκτικό και να εκτελεί τις εργασίες σωλήνωσης που σχετίζονται με την εγκατάσταση, αλλαγή θέσης και αφαίρεση, διαθέτει τα προσόντα που σχετίζονται με αυτές τις εργασίες χειρισμού του ψυκτικού και τις εργασίες σωλήνωσης όπως ορίζεται από τους τοπικούς νόμους και κανονισμούς, και είναι άτομο που έχει εκπαιδευτεί σε θέματα που σχετίζονται με τις εργασίες χειρισμού του ψυκτικού και τις εργασίες σωλήνωσης σε κλιματιστικά που κατασκευάζονται από την Toshiba Carrier Corporation ή, εναλλακτικά, έχει διδαχθεί αυτές τις εργασίες από άτομα που έχουν εκπαιδευτεί και, επομένως, είναι πλήρως εξοικειωμένοι με τις γνώσεις που σχετίζονται με αυτές τις εργασίες. Ο εξειδικευμένος εγκαταστάτης που επιτρέπεται να εργάζεται σε ύψη έχει εκπαιδευτεί σε θέματα που σχετίζονται με τις εργασίες σε ύψη με κλιματιστικά που κατασκευάζονται από την Toshiba Carrier Corporation ή, εναλλακτικά, έχει διδαχθεί αυτές τις εργασίες από άτομα που έχουν εκπαιδευτεί και, επομένως, είναι πλήρως εξοικειωμένοι με τις γνώσεις που σχετίζονται με αυτές τις εργασίες.
Εξειδικευμένος τεχνικός σέρβις	<ul style="list-style-type: none"> Ο εξειδικευμένος τεχνικός επισκευών είναι ένα άτομο που πραγματοποιεί εργασίες εγκατάστασης, επισκευής, συντήρησης, αλλαγής θέσης και αφαίρεσης των κλιματιστικών που κατασκευάζει η Toshiba Carrier Corporation. Το άτομο αυτό έχει εκπαιδευτεί στην εγκατάσταση, επισκευή, συντήρηση, αλλαγή θέσης και αφαίρεση των κλιματιστικών που κατασκευάζει η Toshiba Carrier Corporation ή, εναλλακτικά, έχει διδαχθεί αυτές τις εργασίες από άτομα που έχουν εκπαιδευτεί και είναι επομένως πλήρως εξοικειωμένοι με τις γνώσεις που σχετίζονται με αυτές τις εργασίες. Ο εξειδικευμένος τεχνικός επισκευών που επιτρέπεται να κάνει τις ηλεκτρικές εργασίες που σχετίζονται με την εγκατάσταση, επισκευή, αλλαγή θέσης και αφαίρεση, διαθέτει τα προσόντα που σχετίζονται με αυτές τις ηλεκτρικές εργασίες όπως ορίζεται από τους τοπικούς νόμους και κανονισμούς, και είναι άτομο που έχει εκπαιδευτεί σε θέματα που σχετίζονται με τις ηλεκτρικές εργασίες σε κλιματιστικά που κατασκευάζονται από την Toshiba Carrier Corporation ή, εναλλακτικά, έχει διδαχθεί αυτές τις εργασίες από άτομα που έχουν εκπαιδευτεί και, επομένως, είναι πλήρως εξοικειωμένοι με τις γνώσεις που σχετίζονται με αυτές τις εργασίες. Ο εξειδικευμένος τεχνικός επισκευών που επιτρέπεται να χειρίζεται το ψυκτικό και να εκτελεί τις εργασίες σωλήνωσης που σχετίζονται με την εγκατάσταση, επισκευή, αλλαγή θέσης και αφαίρεση, διαθέτει τα προσόντα που σχετίζονται με αυτές τις εργασίες χειρισμού του ψυκτικού και τις εργασίες σωλήνωσης όπως ορίζεται από τους τοπικούς νόμους και κανονισμούς, και είναι άτομο που έχει εκπαιδευτεί σε θέματα που σχετίζονται με τις εργασίες χειρισμού του ψυκτικού και τις εργασίες σωλήνωσης σε κλιματιστικά που κατασκευάζονται από την Toshiba Carrier Corporation ή, εναλλακτικά, έχει διδαχθεί αυτές τις εργασίες από άτομα που έχουν εκπαιδευτεί και, επομένως, είναι πλήρως εξοικειωμένοι με τις γνώσεις που σχετίζονται με αυτές τις εργασίες. Ο εξειδικευμένος τεχνικός επισκευών που επιτρέπεται να εργάζεται σε ύψη έχει εκπαιδευτεί σε θέματα που σχετίζονται με τις εργασίες σε ύψη με κλιματιστικά που κατασκευάζονται από την Toshiba Carrier Corporation ή, εναλλακτικά, έχει διδαχθεί αυτές τις εργασίες από άτομα που έχουν εκπαιδευτεί και, επομένως, είναι πλήρως εξοικειωμένοι με τις γνώσεις που σχετίζονται με αυτές τις εργασίες.

Ορισμός εξοπλισμού προστασίας

Όταν πραγματοποιείται μεταφορά, εγκατάσταση, συντήρηση, επισκευή ή αφαίρεση του κλιματιστικού, να φοράτε προστατευτικά γάντια και ρουχισμό εργασίας 'ασφαλείας'.

Πέραν του συγκεκριμένου συνήθους εξοπλισμού προστασίας, να φοράτε τον εξοπλισμό προστασίας που περιγράφεται κατωτέρω, όταν αναλαμβάνετε την εκτέλεση των ειδικών εργασιών που αναγράφονται στον πίνακα κατωτέρω.

Η μη χρήση του κατάλληλου εξοπλισμού προστασίας είναι επικίνδυνη, επειδή θα είστε πιο ευάλωτοι σε ενδεχόμενο τραυματισμό, εγκαύματα, ηλεκτροπληξία και άλλους τραυματισμούς.

Εκτελούμενη εργασία	Χρήση εξοπλισμού προστασίας
Κάθε τύπος εργασίας	Γάντια προστασίας Ρουχισμός για την ασφάλεια κατά την εργασία
Ηλεκτρολογικές εργασίες	Ρουχισμός προστασίας από ηλεκτροπληξία Υποδήματα με μόνωση Γάντια για προστασία έναντι ηλεκτροπληξίας
Εργασία σε ύψη (50 cm ή περισσότερο)	Κράνη βιομηχανικής χρήσης
Μεταφορά βαρέων αντικειμένων	Υποδήματα με πρόσθετη προστασία στη μύτη
Επισκευή εξωτερικής μονάδας	Γάντια για προστασία έναντι ηλεκτροπληξίας

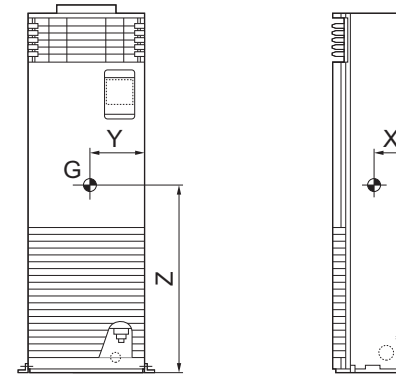

■ Κέντρο βαρύτητας

Όνομα μοντέλου	X (mm)	Y (mm)	Z (mm)
RAV-RM561FT-EN/ES	85	285	820
RAV-RM801FT-EN/ES			
RAV-RM1101FT-EN/ES	195	290	860
RAV-RM1401FT-EN/ES			
RAV-RM1601FT-EN/ES			



■ Προειδοποιητικές ενδείξεις πάνω στη μονάδα κλιματιστικού





Αυτές οι επισημάνσεις προσοχής για την ασφάλεια περιγράφουν σημαντικά ζητήματα που αφορούν την ασφάλεια, για την αποφυγή τραυματισμών σε χρήστες ή άλλα άτομα και ζημιών σε ιδιοκτησία. Διαβάστε το παρόν εγχειρίδιο αφού κατανοήσετε το παρακάτω περιεχόμενο (επεξήγηση ενδείξεων) και βεβαιωθείτε να ακολουθήσετε την περιγραφή.



Ένδειξη	Επεξήγηση ενδείξεων
 ΠΡΟΕΙΔΟΠΟΙΗΣΗ	Το κείμενο που φέρει αυτή την ένδειξη υποδεικνύει ότι η μη συμμόρφωση με τις οδηγίες στην προειδοποίηση μπορεί να προκαλέσει σοβαρό τραυματισμό (*1) ή θάνατο, αν δεν γίνει σωστός χειρισμός του προϊόντος.
 ΠΡΟΣΟΧΗ	Το κείμενο που φέρει αυτή την ένδειξη υποδεικνύει ότι η μη συμμόρφωση με τις οδηγίες στην επισήμανση προσοχής μπορεί να προκαλέσει ελαφρύ τραυματισμό (*2) ή ζημιά (*3) σε ιδιοκτησία, αν δεν γίνει σωστός χειρισμός του προϊόντος.

*1: Ο όρος "σοβαρός τραυματισμός" αναφέρεται σε τύφλωση, τραυματισμό, εγκαύματα, ηλεκτροπληξία, κατάγματα οστών, δηλητηρίαση και άλλους τραυματισμούς, οι οποίοι αφήνουν υπολειμματικές επιπτώσεις και απαιτούν περίθαλψη σε νοσοκομείο ή παρατεταμένη θεραπεία ως εξωτερικός ασθενής.

*2: Ο όρος "ελαφρύς τραυματισμός" αναφέρεται σε τραυματισμό, έγκαυμα, ηλεκτροπληξία και άλλους τραυματισμούς, οι οποίοι δεν απαιτούν περίθαλψη σε νοσοκομείο ή παρατεταμένη θεραπεία ως εξωτερικός ασθενής.

*3: Ο όρος "ζημιά σε ιδιοκτησία" αναφέρεται σε ζημιά που εκτείνεται σε κτίρια, οικιακά είδη, οικόσφαιρα ζώα και κατοικίδια ζώα.

	ΠΡΟΕΙΔΟΠΟΙΗΣΗ (Κίνδυνος πυρκαγιάς)	Αυτό το σήμα αφορά μόνο ψυκτικό R32. Ο τύπος ψυκτικού αναγράφεται στην πινακίδα ονομαστικών τιμών της εξωτερικής μονάδας. Στην περίπτωση που ο τύπος ψυκτικού είναι R32, αυτή η μονάδα χρησιμοποιεί εύφλεκτο ψυκτικό. Αν το ψυκτικό διαρρεύσει και έρθει σε επαφή με φωτιά ή θερμαντικό μέρος, θα δημιουργήσει ένα βλαβερό αέριο και θα υπάρξει κίνδυνος πυρκαγιάς.
	Διαβάστε προσεκτικά το ΕΓΧΕΙΡΙΔΙΟ ΚΑΤΟΧΟΥ πριν τη λειτουργία.	
	Το προσωπικό σέρβις πρέπει να διαβάσει προσεκτικά το ΕΓΧΕΙΡΙΔΙΟ ΚΑΤΟΧΟΥ και το ΕΓΧΕΙΡΙΔΙΟ ΕΓΚΑΤΑΣΤΑΣΗΣ πριν τη λειτουργία.	
	Διατίθενται περαιτέρω πληροφορίες στο ΕΓΧΕΙΡΙΔΙΟ ΚΑΤΟΧΟΥ, στο ΕΓΧΕΙΡΙΔΙΟ ΕΓΚΑΤΑΣΤΑΣΗΣ και άλλα.	

Προειδοποιητική ένδειξη	Περιγραφή		
 <table border="1"> <tr> <td>WARNING</td> </tr> <tr> <td>ELECTRICAL SHOCK HAZARD Disconnect all remote electric power supplies before servicing.</td> </tr> </table>	WARNING	ELECTRICAL SHOCK HAZARD Disconnect all remote electric power supplies before servicing.	ΠΡΟΕΙΔΟΠΟΙΗΣΗ ΚΙΝΔΥΝΟΣ ΗΛΕΚΤΡΟΠΛΗΞΙΑΣ Αποσυνδέστε όλο τον απομακρυσμένο ηλεκτρικό εξοπλισμό πριν κάνετε σέρβις.
WARNING			
ELECTRICAL SHOCK HAZARD Disconnect all remote electric power supplies before servicing.			
 <table border="1"> <tr> <td>WARNING</td> </tr> <tr> <td>Moving parts. Do not operate unit with grille removed. Stop the unit before the servicing.</td> </tr> </table>	WARNING	Moving parts. Do not operate unit with grille removed. Stop the unit before the servicing.	ΠΡΟΕΙΔΟΠΟΙΗΣΗ Κινούμενα μέρη. Μην θέσετε τη μονάδα σε λειτουργία, εάν έχετε αφαιρέσει τη γρίλια. Διακόψτε τη λειτουργία της μονάδας πριν από τη διενέργεια σέρβις.
WARNING			
Moving parts. Do not operate unit with grille removed. Stop the unit before the servicing.			
 <table border="1"> <tr> <td>CAUTION</td> </tr> <tr> <td>Do not touch the aluminum fins of the unit. Doing so may result in injury.</td> </tr> </table>	CAUTION	Do not touch the aluminum fins of the unit. Doing so may result in injury.	ΠΡΟΣΟΧΗ Μην ακουμπάτε τα πτερύγια αλουμινίου της μονάδας. Η μη συμμόρφωση ενδέχεται να προκαλέσει τραυματισμό.
CAUTION			
Do not touch the aluminum fins of the unit. Doing so may result in injury.			

1 Προφυλάξεις για ασφάλεια

Ο κατασκευαστής δεν αναλαμβάνει ευθύνη για τυχόν βλάβες ή θάνατο προκληθούν από αμέλεια συμμόρφωσης με τα όσα περιγράφονται στο παρόν εγχειρίδιο.

ΠΡΟΕΙΔΟΠΟΙΗΣΗ

Γενικά

- Πριν ξεκινήσετε με την εγκατάσταση του κλιματιστικού, διαβάστε με προσοχή το Εγχειρίδιο εγκατάστασης και ακολουθήστε τις οδηγίες για την εγκατάσταση του κλιματιστικού.
- Οι εργασίες εγκατάστασης επιτρέπεται να εκτελούνται μόνο από ειδικευμένο εγκαταστάτη ή ειδικευμένο τεχνικό σέρβις. Αν η εγκατάσταση δεν γίνει με τον ενδεδειγμένο τρόπο, υπάρχει κίνδυνος διαρροών νερού, ηλεκτροπληξίας ή πυρκαγιάς.
- Μη χρησιμοποιήσετε διαφορετικό ψυκτικό από το προβλεπόμενο για συμπλήρωση ή αντικατάσταση. Αλλιώς ενδέχεται να αναπτυχθεί ασυνήθιστα υψηλή πίεση στον κύκλο ψύξης οπότε υπάρχει κίνδυνος βλάβης ή έκρηξης του προϊόντος ή τραυματισμού σας.
- Πριν ανοίξετε τη γρίλια εισαγωγής της εσωτερικής μονάδας ή του πίνακα σέρβις της εξωτερικής μονάδας, φέρτε τον αυτόματο διακόπτη κυκλώματος στη θέση OFF (ΑΠΕΝΕΡΓΟΠΟΙΗΣΗ). Αν δεν φέρετε τον αυτόματο διακόπτη κυκλώματος στη θέση OFF (ΑΠΕΝΕΡΓΟΠΟΙΗΣΗ), υπάρχει κίνδυνος ηλεκτροπληξίας λόγω τυχαίας επαφής με τα εξαρτήματα στο εσωτερικό της μονάδας. Η αφαίρεση της γρίλιας εισαγωγής της εσωτερικής μονάδας ή του πίνακα σέρβις της εξωτερικής μονάδας και η εκτέλεση των απαιτούμενων εργασιών επιτρέπεται να γίνουν μόνο από ειδικευμένο εγκαταστάτη (*1) ή ειδικευμένο τεχνικό σέρβις (*1).
- Πριν από την εκτέλεση εργασιών εγκατάστασης, συντήρησης, επισκευών ή αφαίρεσης, φέρτε τον αυτόματο διακόπτη κυκλώματος στη θέση OFF (ΑΠΕΝΕΡΓΟΠΟΙΗΣΗ). Αλλιώς υπάρχει κίνδυνος ηλεκτροπληξίας.
- Τοποθετήστε σήμα με την ένδειξη «Εκτελούνται εργασίες.» κοντά στον αυτόματο διακόπτη κυκλώματος όση ώρα εκτελούνται εργασίες εγκατάστασης, συντήρησης, επισκευής ή αφαίρεσης. Υπάρχει κίνδυνος ηλεκτροπληξίας αν ο αυτόματος διακόπτης κυκλώματος έρθει τυχαία στη θέση ON (ΕΝΕΡΓΟΠΟΙΗΣΗ).
- Μόνον ειδικευμένος εγκαταστάτης (*1) ή ειδικευμένος τεχνικός σέρβις (*1) επιτρέπεται να αναλαμβάνει την εκτέλεση εργασιών σε ψηλά σημεία χρησιμοποιώντας βάση στήριξης ύψους τουλάχιστον 50 εκατοστών ή να αφαιρεί τη γρίλια εισαγωγής της εσωτερικής μονάδας για την εκτέλεση εργασιών.

- Πρέπει να φοράτε προστατευτικά γάντια και προστατευτική στολή εργασίας κατά την εκτέλεση εργασιών εγκατάστασης, σέρβις και αφαίρεσης.
- Μην αγγίζετε το αλουμινένιο πτερύγιο της μονάδας. Διατρέχετε κίνδυνο τραυματισμού. Αν πρέπει να αγγίξετε το πτερύγιο για κάποιο λόγο, φορέστε πρώτα προστατευτικά γάντια και προστατευτική στολή εργασίας.
- Όταν εκτελείτε εργασία σε ψηλά σημεία, χρησιμοποιήστε σκάλα που συμμορφώνεται προς το πρότυπο ISO 14122 και ακολουθήστε τη διαδικασία που παρατίθεται στις οδηγίες για τη σκάλα. Επίσης, φορέστε κράνος βιομηχανικής χρήσης ως εξοπλισμό προστασίας προτού εκτελέσετε την εργασία.
- Η μονάδα διαθέτει αισθητήρα ανίχνευσης διαρροής ψυκτικού μέσου για ασφάλεια, και για να είναι αποτελεσματική, η μονάδα πρέπει να τροφοδοτείται πάντα με ηλεκτρικό ρεύμα μετά την εγκατάσταση, εκτός από όταν εκτελούνται εργασίες σέρβις. Η απενεργοποίηση του διακόπτη κυκλώματος εμποδίζει τη λειτουργία του αισθητήρα ανίχνευσης διαρροής ψυκτικού μέσου και δεν επιτρέπει την ανίχνευση διαρροών ψυκτικού μέσου, προκαλώντας πυρκαγιά.
- Μη χρησιμοποιείτε ψυκτικό μέσο άλλο εκτός του R32 ή του R410A. Για τον τύπο του ψυκτικού μέσου, ελέγξτε την εξωτερική μονάδα που πρόκειται να συνδυαστεί.
- Πρέπει να διασφαλίζετε την ευστάθεια του κλιματιστικού κατά τη μεταφορά του. Αν κάποιο εξάρτημα του προϊόντος είναι σπασμένο, επικοινωνήστε με τον αντιπρόσωπο.
- Κατά τη μεταφορά του κλιματιστικού με τα χέρια, πρέπει να μεταφέρεται από τέσσερα ή περισσότερα άτομα.
- Η συντήρηση πρέπει να εκτελείται μόνο όπως συνιστάται από τον κατασκευαστή. Υπάρχει υψηλή τάση στο εσωτερικό της μονάδας. Όταν αφαιρέσετε το κάλυμμα και την κεντρική μονάδα, διατρέχετε κίνδυνο ηλεκτροπληξίας.
- Η συγκεκριμένη συσκευή προορίζεται για χρήση από έμπειρους ή καταρτισμένους χρήστες στον κλάδο της ελαφράς βιομηχανίας ή για εμπορική χρήση από μη ειδικούς.

Σχετικά με το ψυκτικό μέσο R32

- Η συσκευή πρέπει να φυλάσσεται σε χώρο χωρίς συνεχή λειτουργία πηγών ανάφλεξης (για παράδειγμα, ακάλυπτες φλόγες, συσκευή αερίου ή ηλεκτρική θερμάστρα σε λειτουργία).
- Μην τρυπάτε ή καίτε μέρη του κύκλου ψύξης.
- Μην χρησιμοποιείτε μέσα για να επιταχύνετε τη διαδικασία απόψυξης ή για τον καθαρισμό, εκτός από εκείνα που συνιστώνται από τον κατασκευαστή.
- Να έχετε υπόψη ότι τα ψυκτικά μέσα είναι άοσμα.
- Οι σωληνώσεις πρέπει να προστατεύονται από φυσικές φθορές.
- Πρέπει να τηρείται η συμμόρφωση με τους εθνικούς κανονισμούς αερίων.
- Εάν ο αισθητήρας ανίχνευσης διαρροής ψυκτικού μέσου ανιχνεύσει διαρροή ψυκτικού μέσου R32, ένας ανεμιστήρας στην εσωτερική μονάδα θα λειτουργήσει αυτόματα για να αναδύσει τον αέρα μέσα στο δωμάτιο. Ο όγκος της ροής αέρα ανάδευσης κάθε μοντέλου εμφανίζεται παρακάτω.

Όνομα μοντέλου	Ροή αέρα ανάδευσης (m ³ /ώρα)
RAV-RM561FT*	820
RAV-RM801FT*	930
RAV-RM1101FT*	1 660
RAV-RM1401FT*	1 760
RAV-RM1601FT*	1 760

Επιλογή θέσης εγκατάστασης

- Όταν το κλιματιστικό είναι τοποθετημένο σε μικρό χώρο, πάρτε τα κατάλληλα μέτρα για να διασφαλίσετε ότι η συγκέντρωση διαρροής ψυκτικού στον χώρο δεν υπερβαίνει το κρίσιμο επίπεδο.
- Μην εγκαταστήσετε τη μονάδα σε χώρο όπου υπάρχει πιθανότητα διαρροής εύφλεκτου αερίου. Σε περίπτωση διαρροής αερίου και συσσώρευσης του γύρω από τη μονάδα υπάρχει κίνδυνος ανάφλεξης του και πυρκαγιάς.
- Για να μεταφέρετε το κλιματιστικό μηχάνημα, να φοράτε υποδήματα με μεταλλικά καλύμματα στις μύτες.
- Για να μεταφέρετε το κλιματιστικό, δεν πρέπει να πιάσετε από τα τσέρκια που υπάρχουν γύρω από το χαρτοκιβώτιο της συσκευασίας του. Αν τυχόν σπάσουν οι ταινίες, διατρέχετε κίνδυνο τραυματισμού.
- Μην τοποθετήσετε συσκευή καύσης σε σημείο που είναι άμεσα εκτεθειμένο στη ροή του αέρα από το κλιματιστικό γιατί ενδέχεται να είναι ατελής η καύση.

- Όταν συνδυάζεται μια εξωτερική μονάδα που χρησιμοποιεί ψυκτικό μέσο R32 με την εσωτερική μονάδα, δώστε προσοχή στην επιφάνεια του δαπέδου στον χώρο όπου θα εγκατασταθεί. Η μονάδα δεν μπορεί να εγκατασταθεί σε χώρο με επιφάνεια δαπέδου μικρότερη από την ελάχιστη επιφάνεια δαπέδου που περιγράφεται στο Παράρτημα του παρόντος Εγχειριδίου εγκατάστασης.

Εγκατάσταση

- Εγκαταστήστε το κλιματιστικό με ασφάλεια σε σημείο όπου η βάση του να μπορεί να στηρίξει επαρκώς το βάρος του. Αν τα σημεία αυτά δεν έχουν αρκετή αντοχή, υπάρχει κίνδυνος να πέσει η μονάδα και να προκληθεί τραυματισμός.
- Για να εγκαταστήσετε το κλιματιστικό, ακολουθήστε τις οδηγίες που παρατίθενται στο Εγχειρίδιο εγκατάστασης. Αν δεν ακολουθήσετε τις οδηγίες αυτές, υπάρχει κίνδυνος πτώσης ή ανατροπής του προϊόντος ή πρόκλησης θορύβου, δόνησης, διαρροής νερού ή άλλων προβλημάτων.
- Εκτελέστε πιστά τις καθορισμένες εργασίες εγκατάστασης για να διασφαλίσετε ότι ο εξοπλισμός θα αντέξει σε ισχυρούς ανέμους ή σεισμό. Αν η εγκατάσταση του κλιματιστικού δεν γίνει με τον ενδεδειγμένο τρόπο, υπάρχει κίνδυνος ανατροπής ή πτώσης κάποιας μονάδας οπότε θα προκληθεί ατύχημα.
- Σε περίπτωση διαρροής του ψυκτικού αερίου κατά τη διάρκεια των εργασιών εγκατάστασης, αερίστε αμέσως τον χώρο. Αν η διαρροή του ψυκτικού αερίου έλθει σε επαφή με φλόγα, ενδέχεται να εκλυθούν δηλητηριώδη αέρια που μπορεί να προκαλέσουν πυρκαγιά.
- Χρησιμοποιήστε περονοφόρο ανυψωτικό για να μεταφέρετε τα εξαρτήματα του κλιματιστικού και βαρούλκο ή παλάγκο για την εγκατάστασή τους.
- Η εγκατάσταση των σωληνώσεων πρέπει να περιορίζεται στο ελάχιστο.

Σωλήνωση ψυκτικού

- Εγκαταστήστε το σωλήνα ψυκτικού με ασφάλεια στη διάρκεια της εργασίας εγκατάστασης πριν θέσετε σε λειτουργία το κλιματιστικό. Εάν ο συμπιεστής λειτουργήσει με τη βαλβίδα ανοιχτή και χωρίς σωλήνα ψυκτικού υγρού, ο συμπιεστής αναρροφά αέρα και ο κύκλος ψύξης υπερσυμπιέζεται, πράγμα το οποίο ενδέχεται να προκαλέσει τραυματισμό.
- Σφίξτε το ρακόρ με ροπόκλειδο με τον καθορισμένο τρόπο. Αν σφίξετε υπερβολικά το ρακόρ, υπάρχει κίνδυνος να ραγίσει μετά από μεγάλο χρονικό διάστημα οπότε ίσως προκληθεί διαρροή του ψυκτικού.

- Μετά τις εργασίες εγκατάστασης, βεβαιωθείτε ότι δεν υπάρχει διαρροή του ψυκτικού αερίου. Τυχόν διαρροή του ψυκτικού αερίου στο χώρο και κίνησή του κοντά σε πηγή φωτιάς, όπως εστία κουζίνας, ενδέχεται να εκλυθούν δηλητηριώδη αέρια που μπορεί να προκαλέσουν πυρκαγιά.
- Όταν ολοκληρωθεί η εγκατάσταση ή η μετεγκατάσταση του κλιματιστικού, ακολουθήστε τις οδηγίες που παρατίθενται στο Εγχειρίδιο εγκατάστασης για πλήρη εξαέρωση ώστε στον κύκλο ψύξης να μην αναμειγνύονται άλλα αέρια εκτός του ψυκτικού. Αν δεν κάνετε πλήρη εξαέρωση, ενδέχεται να προκληθεί δυσλειτουργία του κλιματιστικού.
- Απαιτείται η χρήση αερίου αζώτου για τη δοκιμή της αεροστεγανότητας.
- Πρέπει να συνδέσετε τον εύκαμπτο σωλήνα πλήρωσης έτσι ώστε να μην είναι χαλαρός.

Ηλεκτρική καλωδίωση

- Η εκτέλεση των ηλεκτρολογικών εργασιών στο κλιματιστικό επιτρέπεται μόνο από ειδικευμένο εγκαταστάτη (*1) ή ειδικευμένο τεχνικό σέρβις (*1). Σε καμία περίπτωση δεν επιτρέπεται η εκτέλεση των εν λόγω εργασιών από ανειδίκευτο άτομο επειδή αν οι εργασίες δεν εκτελεστούν όπως πρέπει υπάρχει κίνδυνος ηλεκτροπληξίας και/ή διαρροών ρεύματος.
- Για να συνδέσετε τα καλώδια ρεύματος, την επισκευή ηλεκτρολογικών μερών ή άλλες εργασίες ηλεκτρολογικής φύσης, να φοράτε μονωτικά γάντια (ηλεκτρολόγου), μονωτικά υποδήματα και ενδυμασία για προστασία έναντι ηλεκτροπληξίας. Η μη χρήση του συγκεκριμένου εξοπλισμού προστασίας ενδέχεται να καταλήξει σε ηλεκτροπληξία.
- Χρησιμοποιήστε καλωδιώσεις οι οποίες πληρούν τις προδιαγραφές που παρατίθενται στο Εγχειρίδιο εγκατάστασης και τις διατάξεις των τοπικών κανονισμών και νόμων. Αν χρησιμοποιήσετε καλωδιώσεις που δεν πληρούν τις προδιαγραφές, υπάρχει κίνδυνος ηλεκτροπληξίας, διαρροών ρεύματος, καπνού και/ή πυρκαγιάς.
- Συνδέστε το καλώδιο γείωσης. (Εργασίες γείωσης)
Η ατελής γείωση μπορεί να οδηγήσει σε ηλεκτροπληξία.
- Δεν πρέπει να συνδέσετε τα καλώδια γείωσης με σωλήνες φυσικού αερίου, σωλήνες νερού και αγωγό αλεξικέραυτου ούτε με σύρματα γείωσης τηλεφωνικής γραμμής.
- Μετά την ολοκλήρωση της εργασίας επισκευής ή μετεγκατάστασης, ελέγξτε αν τα σύρματα γείωσης είναι συνδεδεμένα όπως πρέπει.
- Εγκαταστήστε διακόπτη κυκλώματος ο οποίος πληροί τις προδιαγραφές που παρατίθενται στο Εγχειρίδιο εγκατάστασης και τις απαιτήσεις των τοπικών κανονισμών και νόμων.

- Εγκαταστήστε τον διακόπτη κυκλώματος σε σημείο στο οποίο θα μπορεί να αποκτήσει εύκολα πρόσβαση ο αντιπρόσωπος.
- Οπότε χρειαστεί να εγκαταστήσετε τον διακόπτη κυκλώματος σε εξωτερικό χώρο, φροντίστε να είναι σχεδιασμένος για την εν λόγω χρήση.
- Σε καμία περίπτωση, το καλώδιο τροφοδοσίας ή το καλώδιο σύνδεσης της εσωτερικής και της εξωτερικής μονάδας δεν πρέπει να συνδεθεί στη μέση (Σύνδεση με χρήση ακροδέκτη χωρίς συγκόλληση κλπ.)
Τυχόν προβλήματα σύνδεσης στα σημεία, όπου το καλώδιο συνδέεται στη μέση, ενδέχεται να προκαλέσουν καπνό ή/και πυρκαγιά.
- Οι εργασίες ηλεκτρικής καλωδίωσης πρέπει να εκτελούνται σύμφωνα με τους νόμους και κανονισμούς που ισχύουν σε κάθε κοινότητα και με βάση το εγχειρίδιο εγκατάστασης.
Αλλιώς υπάρχει κίνδυνος ηλεκτροπληξίας ή βραχυκυκλώματος.
- Επιβεβαιώστε ότι η καλωδίωση δεν θα υποστεί φθορά, διάβρωση, υπερβολική πίεση, κραδασμούς, επαφή με κοφτερές άκρες ή άλλες δυσμενείς περιβαλλοντικές επιδράσεις. Ο έλεγχος θα πρέπει επίσης να λαμβάνει υπόψη την παλαιώση ή τον συνεχή κραδασμό από πηγές όπως συμπιεστές ή ανεμιστήρες.

Δοκιμαστική λειτουργία

- Μόλις ολοκληρωθούν οι εργασίες και πριν θέσετε το κλιματιστικό σε λειτουργία, ελέγξτε αν έχετε κλείσει το κάλυμμα του κουτιού ηλεκτρικού ελέγχου της εσωτερικής μονάδας και τον πίνακα σέρβις της εξωτερικής μονάδας και φέрте τον διακόπτη κυκλώματος στη θέση ON (ΕΝΕΡΓΟΠΟΙΗΣΗ). Αν ενεργοποιήσετε την παροχή ρεύματος χωρίς να πραγματοποιήσετε τους ελέγχους αυτούς, διατρέχετε κίνδυνο ηλεκτροπληξίας.
- Αν έχει παρουσιαστεί πρόβλημα οιοδήποτε είδους στο κλιματιστικό (π.χ. ένδειξη σφάλματος, οσμή καμένου, ασυνήθιστοι θόρυβοι, αποτυχία ψύξης ή θέρμανσης ή διαρροή νερού), μην αγγίζετε το κλιματιστικό αλλά φέрте τον διακόπτη κυκλώματος στη θέση OFF (ΑΠΕΝΕΡΓΟΠΟΙΗΣΗ) και επικοινωνήστε με ειδικευμένο τεχνικό. Πάρτε μέτρα για να διασφαλίσετε ότι δεν θα είναι εφικτή η ενεργοποίηση της παροχής ρεύματος (π.χ. αναρτώντας πινακίδα με την ένδειξη «εκτός λειτουργίας» κοντά στον διακόπτη κυκλώματος) ωσότου φτάσει ο ειδικευμένος τεχνικός σέρβις. Αν συνεχίσετε να χρησιμοποιείτε το κλιματιστικό μηχάνημα παρόλο που παρουσιάζει πρόβλημα, υπάρχει κίνδυνος επιδείνωσης των μηχανικών προβλημάτων ή πρόκλησης ηλεκτροπληξίας ή άλλων προβλημάτων.

- Μόλις ολοκληρωθούν οι εργασίες, χρησιμοποιήστε κατάλληλη συσκευή για τον έλεγχο της μόνωσης (500VΜΩ) για να ελέγξετε εάν η αντίσταση είναι 1 ΜΩ ή περισσότερο μεταξύ ηλεκτροφόρου τμήματος και μη ηλεκτροφόρου μεταλλικού τμήματος (τμήμα γείωσης). Εάν η τιμή αντίστασης είναι χαμηλή, θα προκληθεί σοβαρή ζημιά στην πλευρά του χρήστη, όπως διαρροή ρεύματος ή ηλεκτροπληξία.
- Μόλις ολοκληρωθούν οι εργασίες εγκατάστασης, ελέγξτε μήπως υπάρχουν διαρροές του ψυκτικού και επιθεωρήστε την αντίσταση της μόνωσης και τον σωλήνα αποστράγγισης του νερού. Ύστερα θέστε το κλιματιστικό σε δοκιμαστική λειτουργία για να ελέγξετε αν λειτουργεί όπως πρέπει.

Επεξηγήσεις που παρέχονται στο χρήστη

- Μόλις ολοκληρωθούν οι εργασίες εγκατάστασης, πείτε στον χρήστη που βρίσκεται ο διακόπτης κυκλώματος. Αν ο χρήστης δεν γνωρίζει πού βρίσκεται ο διακόπτης κυκλώματος, δεν θα μπορέσει να τον απενεργοποιήσει στην περίπτωση που θα προκύψει κάποιο πρόβλημα στο κλιματιστικό.
- Μετά τις εργασίες εγκατάστασης ακολουθήστε τις οδηγίες που παρατίθενται στο Εγχειρίδιο κατόχου για να εξηγήσετε στον πελάτη πώς πρέπει να χρησιμοποιεί και να συντηρεί τη μονάδα.

Μετεγκατάσταση

- Η μετεγκατάσταση του κλιματιστικού επιτρέπεται να εκτελείται μόνον από ειδικευμένο εγκαταστάτη (*1) ή ειδικευμένο τεχνικό σέρβις (*1). Αν η μετεγκατάσταση του κλιματιστικού γίνει από ανειδίκευτο άτομο, υπάρχει κίνδυνος να πυρκαγιάς, ηλεκτροπληξίας, τραυματισμού, διαρροής νερού, θορύβου και/ή δόνησης.
- Κατά την εκτέλεση εργασιών άντλησης διακόψτε τη λειτουργία του συμπιεστή προτού αποσυνδέσετε τον σωλήνα του ψυκτικού. Αν αποσυνδέσετε τον σωλήνα του ψυκτικού έχοντας αφήσει ανοιχτή τη βαλβίδα λειτουργίας και ενώ συνεχίζει να λειτουργεί ο συμπιεστής, θα προκληθούν αναρρόφηση αέρα ή άλλου αερίου, αύξηση της πίεσης εντός του κύκλου ψύξης σε μη φυσιολογικά υψηλά επίπεδα και ενδεχομένως ράγισμα, τραυματισμός ή άλλα προβλήματα.

(*1) Ανατρέξτε στην ενότητα «Ορισμός Εξειδικευμένου Εγκαταστάτη ή Εξειδικευμένου Τεχνικού Σέρβις».

⚠ ΠΡΟΣΟΧΗ

Στο συγκεκριμένο Κλιματιστικό έχει υιοθετηθεί η χρήση ψυκτικού HFC (R32 ή R410A) που δεν καταστρέφει τη στιβάδα του όζοντος.

- Καθώς το ψυκτικό μέσο R32 ή R410A επηρεάζεται εύκολα από ακαθαρσίες όπως υγρασία, οξειδωμένο φιλμ, λάδι κλπ., λόγω της υψηλής πίεσης, προσέξτε να μην επιτραπεί η ανάμιξη υγρασίας, ακαθαρσιών, υπάρχοντος ψυκτικού, ψυκτικού ελαίου κλπ. κατά τη διάρκεια των εργασιών εγκατάστασης.
- Απαιτείται ένα ειδικό εργαλείο για το ψυκτικό R32 ή R410A για την εγκατάσταση.
- Χρησιμοποιήστε ένα νέο και καθαρό υλικό σωληνώσεων για τον σωλήνα σύνδεσης, έτσι ώστε η υγρασία και οι ακαθαρσίες να μην αναμιγνύονται μαζί κατά τη διάρκεια των εργασιών εγκατάστασης.
- Όταν χρησιμοποιείτε τις υπάρχουσες σωληνώσεις, ακολουθείτε το εγχειρίδιο εγκατάστασης που παρέχεται μαζί με την εξωτερική μονάδα.
- Προσέχετε τον χειρισμό του ανεμιστήρα όταν είναι ενεργοποιημένος ο διακόπτης κυκλώματος. Εάν ο αισθητήρας ανίχνευσης διαρροής ψυκτικού μέσου ανιχνεύσει διαρροή, ένας ανεμιστήρας θα περιστραφεί αυτόματα ακόμα και όταν έχει σταματήσει το κλιματιστικό. Προσέξτε να μην τραυματιστείτε από τον ανεμιστήρα.

Благодарим вас за то, что приобрели кондиционер Toshiba.
Внимательно прочтите данные инструкции, содержащие важную информацию, соответствующую директиве "Механическое оборудование" (Директива 2006/42/ЕС), и убедитесь, что они вам понятны. После прочтения обязательно храните данные инструкции в надежном месте вместе с руководством по эксплуатации и руководством по установке, прилагаемыми к изделию.

Общее обозначение: Кондиционер Воздуха

Определение квалифицированного монтажника или квалифицированного специалиста по обслуживанию

Этот кондиционер должен устанавливаться, обслуживаться, ремонтироваться и демонтироваться квалифицированным монтажником или квалифицированным специалистом по обслуживанию. Каждый раз, когда вам нужно будет проделать какую-либо из этих операций, обращайтесь к квалифицированному монтажнику или специалисту по обслуживанию.
Квалифицированный монтажник или квалифицированный специалист по обслуживанию — это лицо, имеющее квалификацию и знания, указанные в таблице ниже.

Лицо	Необходимые квалификация и знания
Квалифицированный монтажник	<ul style="list-style-type: none"> Квалифицированный монтажник — это лицо, которое устанавливает, обслуживает, перемещает и демонтирует кондиционеры производства компании Toshiba Carrier Corporation. Он или она прошел обучение по вопросам установки, технического обслуживания, переустановки и демонтажа кондиционеров производства компании Toshiba Carrier Corporation, или же был научен таким действиям лицом или лицами, получившими необходимое обучение, и поэтому детально знаком со всем, что относится к указанным действиям. Квалифицированный монтажник, допущенный к выполнению необходимых электротехнических работ при установке, переустановке и демонтаже, имеет соответствующую этим работам квалификацию, предусмотренную местным законодательством и нормативами, и представляет собой лицо, обученное вопросам электротехнического характера, связанным с кондиционерами производства компании Toshiba Carrier Corporation, или же он был научен таким вопросам лицом или лицами, прошедшими необходимую подготовку, и поэтому детально знаком со всем, что относится к такой работе. Квалифицированный монтажник, допущенный к выполнению необходимых работ по прокладке трубок хладагента и обращению с хладагентом при установке, переустановке и демонтаже, имеет соответствующую этим работам квалификацию, предусмотренную местным законодательством и нормативами, и представляет собой лицо, обученное вопросам прокладки трубок хладагента и обращению с хладагентом, связанным с кондиционерами производства компании Toshiba Carrier Corporation, или же он был научен таким вопросам лицом или лицами, прошедшими необходимую подготовку, и поэтому детально знаком со всем, что относится к такой работе. Квалифицированный монтажник, допущенный к выполнению высотных работ, был обучен по вопросам, связанным с работой на высоте с кондиционерами производства Toshiba Carrier Corporation, или же получил указания по данному вопросу от лица или лиц, которые были этому обучены, и поэтому детально знаком со всем, что относится к такой работе.
Квалифицированный специалист по обслуживанию	<ul style="list-style-type: none"> Квалифицированный специалист по обслуживанию — это лицо, которое устанавливает, ремонтирует, обслуживает, перемещает и демонтирует кондиционеры производства компании Toshiba Carrier Corporation. Он или она прошел обучение по вопросам установки, ремонта, технического обслуживания, переустановки и демонтажа кондиционеров производства компании Toshiba Carrier Corporation, или же был обучен таким действиям лицом или лицами, получившими необходимое обучение, и поэтому детально знаком со всем, что относится к указанным действиям. Квалифицированный специалист по обслуживанию, допущенный к выполнению необходимых электротехнических работ при установке, ремонте, переустановке и демонтаже, имеет соответствующую этим работам квалификацию, предусмотренную местным законодательством и нормативами, и представляет собой лицо, обученное вопросам электротехнического характера, связанным с кондиционерами производства компании Toshiba Carrier Corporation, или же он был обучен таким вопросам лицом или лицами, прошедшими необходимую подготовку, и поэтому детально знаком со всем, что относится к такой работе. Квалифицированный специалист по обслуживанию, допущенный к выполнению необходимых работ по прокладке трубок хладагента и обращению с хладагентом при установке, ремонте, переустановке и демонтаже, имеет соответствующую этим работам квалификацию, предусмотренную местным законодательством и нормативами, и представляет собой лицо, обученное вопросам прокладки трубок хладагента и обращению с хладагентом, связанным с кондиционерами производства компании Toshiba Carrier Corporation, или же он был обучен таким вопросам лицом или лицами, прошедшими необходимую подготовку, и поэтому детально знаком со всем, что относится к такой работе. Квалифицированный специалист по обслуживанию, допущенный к выполнению высотных работ, был обучен по вопросам, связанным с работой на высоте с кондиционерами производства Toshiba Carrier Corporation, или же получил указания по данному вопросу от лица или лиц, которые были этому обучены, и поэтому детально знаком со всем, что относится к такой работе.

Определение средств индивидуальной защиты

При перевозке, установке, техническом обслуживании, ремонте или демонтаже кондиционера одевайте защитные перчатки и спецодежду.
В дополнение к обычным средствам индивидуальной защиты нужно пользоваться средствами индивидуальной защиты, указанными ниже, при выполнении специальных работ, перечисленных в таблице ниже.
Если не использовать надлежащие средства индивидуальной защиты, возрастает опасность получить травму, ожоги, удар электрическим током или другие повреждения.

Выполняемая работа	Необходимые средства индивидуальной защиты
Все типы работы	Защитные перчатки Защитная рабочая спецодежда
Электротехнические работы	Одежда, обеспечивающая защиту от удара электрическим током Изоляционные ботинки Перчатки для защиты от поражения электрическим током
Работы, выполняемые на высоте (50 см или выше)	Промышленная каска
Переноска тяжелых предметов	Ботинки с дополнительным защитным носком
Ремонт наружных блоков	Перчатки для защиты от поражения электрическим током

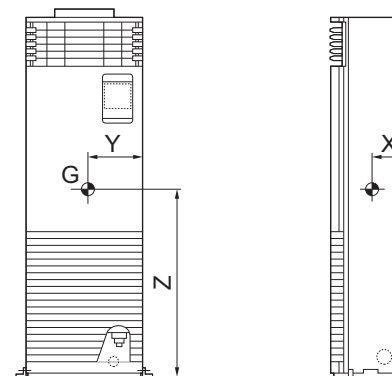

■ Центр тяжести

Модель	X (мм)	Y (мм)	Z (мм)
RAV-RM561FT-RU/ES	85	285	820
RAV-RM801FT-RU/ES			
RAV-RM1101FT-RU/ES	195	290	860
RAV-RM1401FT-RU/ES			
RAV-RM1601FT-RU/ES			



■ Предупредительные указания на кондиционере





Настоящие меры предосторожности описывают важные аспекты, касающиеся безопасности и направленные на предотвращение травм пользователей или других людей и ущерба имуществу. Полностью прочитайте данное руководство, предварительно изучив приведенную ниже информацию (значение обозначений), и следуйте описанию.



Обозначение	Значение обозначений
 ПРЕДУПРЕЖДЕНИЕ	Текст, отмеченный таким образом, указывает, что несоблюдение указаний в предупреждении может привести к серьезному телесному повреждению (*1) или смерти в случае неправильного обращения с изделием.
 ВНИМАНИЕ	Текст, отмеченный таким образом, указывает, что несоблюдение указаний в предостережении может привести к легкому телесному повреждению (*2) или повреждению имущества (*3) в случае неправильного обращения с изделием.

*1: Серьезное телесное повреждение включает потерю зрения, травму, ожоги, поражение электрическим током, перелом, отравление и другие повреждения, имеющие последствия и требующие госпитализации или длительного амбулаторного лечения.

*2: Легкое телесное повреждение включает травму, ожоги, поражение электрическим током и другие повреждения, не требующие госпитализации или длительного амбулаторного лечения.

*3: Повреждение имущества включает повреждение зданий, домашнего имущества, домашнего скота и домашних питомцев.

	ПРЕДУПРЕЖДЕНИЕ (Опасность возгорания)	Это обозначение относится только к хладагенту R32. Тип хладагента указан на паспортной табличке наружного блока. В случае использования хладагента R32 настоящее оборудование использует огнеопасный хладагент. В случае утечки хладагента и его контакте с огнем или нагревательным элементом образуется вредный газ и возникает опасность возгорания.
		Перед эксплуатацией внимательно прочитайте руководство по эксплуатации.
		Технический персонал перед проведением работ должен внимательно прочитать Руководство по эксплуатации и руководство по установке.
		Более подробная информация приведена в руководстве по эксплуатации, руководстве по установке и других аналогичных документах.

Предупреждающий символ	Описание		
 <table border="1"> <tr> <td>WARNING</td> </tr> <tr> <td>ELECTRICAL SHOCK HAZARD Disconnect all remote electric power supplies before servicing.</td> </tr> </table>	WARNING	ELECTRICAL SHOCK HAZARD Disconnect all remote electric power supplies before servicing.	ПРЕДУПРЕЖДЕНИЕ ОПАСНОСТЬ ПОРАЖЕНИЯ ЭЛЕКТРИЧЕСКИМ ТОКОМ Перед выполнением обслуживания нужно отключить все внешние источники электроэнергии.
WARNING			
ELECTRICAL SHOCK HAZARD Disconnect all remote electric power supplies before servicing.			
 <table border="1"> <tr> <td>WARNING</td> </tr> <tr> <td>Moving parts. Do not operate unit with grille removed. Stop the unit before the servicing.</td> </tr> </table>	WARNING	Moving parts. Do not operate unit with grille removed. Stop the unit before the servicing.	ПРЕДУПРЕЖДЕНИЕ Движущиеся части. Запрещается работать на устройстве при движущейся решетке. Перед обслуживанием устройство нужно остановить.
WARNING			
Moving parts. Do not operate unit with grille removed. Stop the unit before the servicing.			
 <table border="1"> <tr> <td>CAUTION</td> </tr> <tr> <td>Do not touch the aluminum fins of the unit. Doing so may result in injury.</td> </tr> </table>	CAUTION	Do not touch the aluminum fins of the unit. Doing so may result in injury.	ВНИМАНИЕ Не касайтесь алюминиевого оребрения на устройстве. Это может привести к травме.
CAUTION			
Do not touch the aluminum fins of the unit. Doing so may result in injury.			

1 Меры предосторожности

Производитель не несет ответственности за ущерб, вызванный несоблюдением инструкций, приведенных в данном руководстве.

ПРЕДУПРЕЖДЕНИЕ

Общие меры предосторожности

- Прежде чем приступить к установке кондиционера, внимательно прочтите руководство по установке и в процессе работы соблюдайте изложенные в нем инструкции.
- Выполнение работы по установке разрешается только квалифицированному монтажнику или квалифицированному специалисту по обслуживанию. Неправильная установка может привести к утечке воды, поражению электрическим током или воспламенению.
- Запрещается использовать для пополнения или замены хладагент, отличный от указанного. В противном случае в контуре охлаждения может образоваться аномально высокое давление, что может привести к поломке или взрыву изделия, а также вызвать травмы.
- Прежде чем открывать решетку воздухозаборника внутреннего блока или служебную панель наружного блока, переведите сетевой выключатель в положение OFF (ВЫКЛ.). Если сетевой выключатель не переведен в положение OFF (ВЫКЛ.), возможно поражение электрическим током при контакте с внутренними узлами кондиционера. Снимать решетку воздухозаборника внутреннего блока или служебную панель наружного блока и выполнять необходимые работы разрешается только квалифицированным монтажникам (*1) или квалифицированным специалистам по обслуживанию (*1).
- Перед выполнением работ по установке, техническому обслуживанию, ремонту или демонтажу переведите сетевой выключатель в положение OFF (ВЫКЛ.). В противном случае возможно поражение электрическим током.
- На время выполнения работ по установке, обслуживанию, ремонту или демонтажу кондиционера рядом с сетевым выключателем следует поместить знак “Ведутся работы”. Если кто-либо по ошибке установит выключатель в положение ON (ВКЛ.), возможно поражение работающего электрическим током.

- Работать на подставке высотой 50 см или более и снимать решетку воздухозаборника внутреннего блока для выполнения работ разрешается только квалифицированному монтажнику (*1) или квалифицированному специалисту по обслуживанию (*1).
- При установке, обслуживании и демонтаже следует пользоваться защитными перчатками и спецодеждой.
- Не касайтесь алюминиевого оребрения на устройстве. В противном случае можно получить травму. Если нужно зачехлить оребрение, сначала наденьте защитные перчатки и спецодежду, а затем продолжайте работу.
- При работе на высоте необходимо пользоваться лестницей, отвечающей требованиям стандарта ISO 14122, и следовать указаниям в инструкции к лестнице. При выполнении работ также нужно надевать промышленную каску.
- Это устройство оборудовано датчиком обнаружения утечки хладагента для обеспечения безопасности. После установки питание на устройство должно подаваться постоянно для обеспечения эффективности работы (за исключением проведения обслуживания). Выключение сетевого выключателя приводит к тому, что датчик обнаружения утечки хладагента не функционирует и не может обнаружить утечку хладагента, что может стать причиной возгорания.
- Не используйте другие хладагенты кроме R32 или R410A. Проверьте тип хладагента, который используется в добавляемом наружном блоке.
- При перевозке кондиционер должен находиться в устойчивом положении. В случае повреждения какой-либо части изделия обратитесь к дилеру.
- Переноску кондиционера должны осуществлять четыре или более человек.
- Обслуживание должно выполняться только в соответствии с рекомендациями производителя. Внутри блока находятся компоненты под высоким напряжением. При снятии крышки и основного блока возможно поражение электрическим током.
- Прибор предназначен для использования специалистами или обученными пользователями в магазинах, в легкой промышленности, а также для коммерческого использования неспециалистами.

О хладагенте R32

- Прибор должен храниться в помещении без постоянно работающих источников возгорания (например: открытого огня, газовых приборов или электрических обогревателей).
- Не прокалывайте и не сжигайте части цикла охлаждения.
- Не используйте средства для ускорения процесса размораживания или очистки, кроме тех, которые рекомендованы производителем.
- Помните, что хладагенты не содержат запахов.
- Трубопровод должен быть защищен от физического повреждения.
- Соблюдайте национальные газовые правила.
- Если датчик обнаружения утечки хладагента обнаруживает утечку хладагента R32, автоматически включается вентилятор на внутреннем блоке для перемешивания воздуха в помещении. Объем перемешиваемого воздушного потока каждой модели показан ниже.

Модель	Поток воздуха при перемешивании (м ³ /ч)
RAV-RM561FT*	820
RAV-RM801FT*	930
RAV-RM1101FT*	1 660
RAV-RM1401FT*	1 760
RAV-RM1601FT*	1 760

Выбор места установки

- При установке кондиционера в небольшом помещении необходимо принять надлежащие меры, чтобы не допустить превышения предельной концентрации хладагента в случае его утечки.
- Запрещается устанавливать изделие в месте, где возможны утечки горючего газа. В случае утечки газа и концентрации его вокруг блока газ может воспламениться и стать причиной пожара.
- При транспортировке кондиционера необходимо надевать ботинки с дополнительным защитным носком.
- При транспортировке кондиционера не беритесь за обвязку вокруг картонной упаковки. Если обвязка лопнет, вы можете получить травму.

- Не устанавливайте никакие топливосжигающие устройства в местах, где на них будет непосредственно попадать воздушный поток от кондиционера, так как это может приводить к неполному сгоранию.
- Когда внешнее устройство с хладагентом R32 используется в комбинации с внутренним устройством, обратите особое внимание полу в помещении для установки. Устройство нельзя устанавливать в помещении с площадью пола меньше минимальной площади, описанной в приложении к данному руководству по установке.

Установка

- Кондиционер следует надежно устанавливать на основании, достаточно прочном, чтобы выдержать его вес. Если прочности недостаточно, то блок может упасть, нанеся травму.
- При установке кондиционера следуйте указаниям руководства по установке. Несоблюдение этих инструкций может привести к падению или опрокидыванию изделия, появлению шума, вибрации, утечки воды и другим поломкам.
- При установке примите меры для защиты от сильного ветра и землетрясений. В случае ненадлежащей установки кондиционера блок может упасть или опрокинуться и стать причиной несчастного случая.
- В случае утечки хладагента во время монтажных работ немедленно проветрите помещение. При контакте газообразного хладагента с огнем может образоваться токсичный газ, который может воспламениться.
- Перевозить блоки кондиционера следует с помощью вилочного погрузчика, а поднимать на месте установки — с помощью подъемника или лебедки.
- Работа по монтажу труб должна быть сведена к минимуму.

Трубопровод хладагента

- Перед началом эксплуатации кондиционера надежно смонтируйте и закрепите трубопровод. Если компрессор работает с открытым клапаном и без трубопровода, компрессор засасывает воздух и в контуре охлаждения давление поднимается выше нормы, что может привести к травмированию окружающих.
- Затягивайте конусную гайку динамометрическим ключом в указанном порядке. Чрезмерная затяжка конусной гайки может привести к тому, что со временем на ней образуется трещина, которая может привести к утечке хладагента.

- По окончании монтажных работ убедитесь в отсутствии утечек хладагента. Утечка хладагента и формирование его потока в непосредственной близости от источников огня, например, кухонной плиты, может приводить к образованию токсичного газа, который может воспламениться.
- При установке и переустановке кондиционера соблюдайте инструкции, приведенные в руководстве по установке, и полностью удаляйте воздух из контура хладагента, чтобы никакие газы не смешивались в нем с хладагентом. Если не удалить воздух полностью, это может привести к неполадкам в работе кондиционера.
- Для проверки на герметичность используйте азот.
- Загрузочный шланг нужно подсоединять без слабины.

Электропроводка

- Проводить электротехнические работы с кондиционером разрешается только квалифицированному монтажнику (*1) или квалифицированному специалисту по обслуживанию (*1). Ни при каких обстоятельствах эти работы нельзя поручать неквалифицированным лицам, иначе при неправильном выполнении работ возможны поражения электрическим током и/или утечка электроэнергии.
- При подключении электропроводки, ремонте электрических узлов или выполнении других электротехнических работ нужно надевать защитные перчатки для электриков, изолирующие ботинки и одежду, чтобы защититься от поражения электрическим током. Если этого не сделать, возможно поражение электрическим током.
- Используйте электропроводку, которая отвечает техническим характеристикам, приведенным в данном руководстве по установке, а также местным нормативам и требованиям законодательства. Использование электропроводки, не отвечающей техническим требованиям, может привести к поражению электрическим током, утечкам электроэнергии, задымлению и/или пожару.
- Выполняйте подключение провода заземления (работы по заземлению). Невыполнение заземления может стать причиной поражения электрическим током.
- Не подсоединяйте провода заземления к газопроводным и водопроводным трубам, громоотводам и проводам заземления телефонных линий.

- По окончании ремонтных работ или работ по переустановке кондиционера убедитесь в правильности подсоединения проводов заземления.
- Пользуйтесь сетевыми выключателями, которые отвечают техническим характеристикам, приведенным в данном руководстве по установке, а также местным нормативам и требованиям законодательства.
- Устанавливать сетевой выключатель нужно в легкодоступном месте.
- При установке наружных сетевых выключателей нужно использовать такие их типы, которые предназначены для установки вне помещений.
- Ни при каких обстоятельствах не следует подключать силовой кабель или соединительный провод внутреннего и наружного блоков посередине (подключение с помощью разъемной клеммы и т. д.). Нарушение соединения в местах подключения провода посередине может вызвать задымление и/или пожар.
- Работы по прокладке электропроводки должны выполняться в соответствии с местным законодательством и нормативами и отвечать требованиям руководства по установке. В противном случае возможно поражение электрическим током или короткое замыкание.
- Убедитесь, что проводка не будет подвержена износу, коррозии, избыточному давлению, вибрации, острым краям или любым другим неблагоприятным воздействиям окружающей среды. Проверка также должна учитывать влияние старения или постоянной вибрации от таких источников, как компрессоры или вентиляторы.

Испытание

- Перед тем, как запускать кондиционер после окончания работ с ним, убедитесь, что закрыты крышка электрического блока управления внутреннего блока и служебная панель наружного блока, и переведите сетевой выключатель в положение ON (ВКЛ.). При включении питания без предварительного выполнения указанных проверок возможно поражение электрическим током.

- Если возникли какие-либо неполадки в работе кондиционера (например, отобразился код проверки, появился запах гари, слышны странные звуки, кондиционер не охлаждает или не нагревает воздух, подтекает вода), не прикасайтесь к кондиционеру, переведите его сетевой выключатель в положение OFF (ВЫКЛ.) и вызовите квалифицированного специалиста по обслуживанию. Позаботьтесь, чтобы до прибытия квалифицированного специалиста по обслуживанию не включалось электропитание кондиционера (например, разместите рядом с сетевым выключателем знак “Не работает”). Дальнейшая эксплуатация неисправного кондиционера может привести к усугублению механических проблем, поражению электрическим током или возникновению других неисправностей.
- По окончании работ воспользуйтесь устройством для проверки изоляции (500 VMΩ) для проверки того, что сопротивление между участком под напряжением и участком не под напряжением (заземлением) равно 1 МОм или более. Если сопротивление мало, это значит, что на стороне пользователя произошла утечка электричества или пробой.
- По завершении установочных работ проверьте наличие утечек хладагента, сопротивление изоляции и слив воды. Затем выполните пробный пуск, чтобы удостовериться в правильной работе кондиционера.

Пояснения для пользователя

- По завершении установочных работ покажите пользователю, где находится сетевой выключатель. Если пользователь не знает расположения сетевого выключателя, он не сможет выключить его в случае проблем с кондиционером.
- Выполнив установочные работы, объясните клиенту правила эксплуатации и обслуживания устройства в соответствии с руководством пользователя.

Переустановка на другое место

- Переустанавливать кондиционер разрешается только квалифицированному монтажнику (*1) или квалифицированному специалисту по обслуживанию (*1). В результате переустановки кондиционера неквалифицированным лицом возможны пожар, поражение электрическим током, травмы, утечка воды, шум и/или вибрация.

- При выполнении сливных работ нужно остановить компрессор до отсоединения трубопровода хладагента. Отсоединение трубопровода хладагента при открытом клапане обслуживания и работающем компрессоре приведет к подосу воздуха или другого газа, в результате чего давление в контуре охлаждения достигнет аномально высокого уровня, что может привести к разрыву контура, травме или другим проблемам.







(*1) См. раздел “Определение квалифицированного монтажника или квалифицированного специалиста по обслуживанию”.

⚠ ВНИМАНИЕ

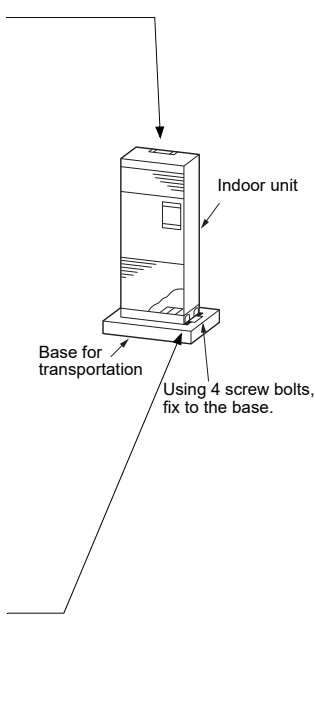
В данном кондиционере используется хладагент на основе ГФУ (R32 или R410A), не разрушающий озоновый слой.

- Поскольку на хладагент R32 или R410A легко воздействуют примеси, такие как влага, окисленная пленка, масло и т. д., из-за высокого давления, будьте осторожны, чтобы не допустить попадания влаги, грязи, имеющегося хладагента, масла в холодильных машинах и т. д. в контур охлаждения во время монтажных работ.
- Для установки хладагента R32 или R410A требуется специальный инструмент.
- Используйте новые и чистые трубопроводные материалы для соединения труб, чтобы в процессе монтажа не смешивались влага и грязь.
- При использовании имеющихся труб следуйте руководству по установке, прилагаемому к наружному блоку.
- Будьте осторожны при работе вблизи внутреннего блока, когда сетевой выключатель включен. Если датчик обнаружения утечки хладагента обнаруживает утечку хладагента, вентилятор вращается автоматически даже при остановке кондиционера. Будьте осторожны, чтобы не пораниться от вентилятора.

2 Accessory parts

Attached position	Part name	Q'ty	Shape	Stored position
Upper part of main unit	Bracket for fixing to wall	1		
Accessory bag	Owner's Manual	1	—	
	Installation Manual	1	—	
	Owner's Manual of remote controller	1	—	
	Installation Manual of remote controller	1	—	
	CD-R	2	—	
	Heat insulator	2		
	Screw bolt	2		
	Binding band	4		
Lower part of main unit	Bracket for fixing to floor	2	RM56, RM80 type 	
		4	RM110 to RM160 type 	

3 Selection of installation place

⚠ WARNING

- **Install the air conditioner securely in a location where the base can sustain the weight adequately.**
If the strength is not enough, the unit may fall down resulting in injury.

⚠ CAUTION

- **Do not install in a location where flammable gas may leak.**
If the gas leaks and accumulates around the unit, it may ignite and cause a fire.
- **Do not install an air conditioner in a place where smoke, chemical agent, or organic solvent is present. Do not use gas equipment using combustion gas (LPG etc.) such as propane, butane, or methane, an insecticide, or sprays or paints containing siloxane, near the indoor unit.**
The refrigerant leak detection sensor operates mistakenly, causing the air conditioner not to operate.
- **When an outdoor unit using R32 refrigerant is combined with indoor unit, be attention to the floor area in the room to be installed.**
The unit cannot be installed in the room with floor space less than minimum floor area described in Appendix of this Installation Manual.

Avoid installing in the following places.

Select a location for the indoor unit where the cool or warm air will circulate evenly.

Avoid installation in the following kinds of locations.

- Saline area (coastal area).
- Locations with acidic or alkaline atmospheres (such as areas with hot springs, factories where chemicals or pharmaceuticals are made and places where the exhaust air from combustion appliances will be sucked into the unit).
Doing so may cause the heat exchanger (its aluminum fins and copper pipes) and other parts to become corroded.
- Locations with atmospheres with mist of cutting oil or other types of machine oil.
Doing so may cause the heat exchanger to become corroded, mists caused by the blockage of the heat exchanger to be generated, the plastic parts to be damaged, the heat insulators to peel off, and other such problems to result.
- Places where iron or other metal dust is present. If iron or other metal dust adheres to or collects on the interior of the air conditioner, it may spontaneously combust and start a fire.
- Locations where vapors from food oils are formed (such as kitchens where food oils are used).
Blocked filters may cause the air conditioner's performance to deteriorate, condensation to form, the plastic parts to be damaged, and other such problems to result.
- Locations near obstructions such as ventilation openings or lighting fixtures where the flow of the blown air will be disrupted (a disruption of the air flow may cause the air conditioner's performance to deteriorate or the unit to shut down).
- Locations where an in-house power generator is used for the power supply.
The power line frequency and voltage may fluctuate, and the air conditioner may not work properly as a result.
- On truck cranes, ships or other moving conveyances.
- The air conditioner must not be used for special applications (such as for storing food, plants, precision instruments or art works).
(The quality of the items stored may be degraded.)
- Locations where high frequencies are generated (by inverter equipment, in-house power generators, medical equipment or communication equipment).
(Malfunctioning or control trouble in the air conditioner or noise may adversely affect the equipment's operation.)
- Locations where there is anything under the unit installed that would be compromised by wetness.
(If the drain has become blocked or when the humidity is over 80%, condensation from the indoor unit will drip, possibly causing damage to anything underneath.)

- In the case of the wireless type of system, rooms with the inverter type of fluorescent lighting or locations exposed to direct sunlight.
(The signals from the wireless remote controller may not be sensed.)
- Locations where organic solvents are being used.
- The air conditioner cannot be used for liquefied carbonic acid cooling or in chemical plants.
- Location near doors or windows where the air conditioner may come into contact with high-temperature, high-humidity outdoor air.
(Condensation may occur as a result.)
- Locations where special sprays are used frequently.

■ Installation space

(Unit: mm)

Reserve sufficient space required for installation or service work.

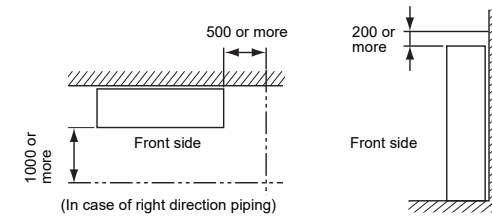

REQUIREMENT

When using the air conditioner under condition of high humidity, attach the heat insulator to the side face and the rear side of the indoor unit.

■ To open the intake grille

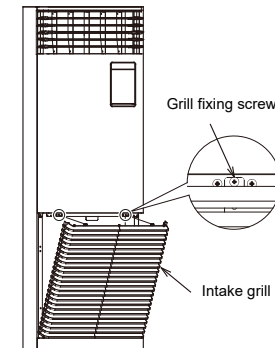

The intake grille is fixed by the screws for safety reasons. Use a screwdriver to unfasten the screws of the intake grille (two places) to open the intake grille. The screws are designed to stay on the intake grille.

Direction of vertical louver

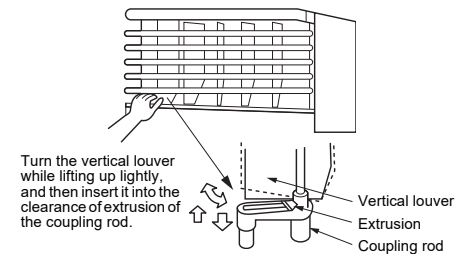

The direction of the auto turn louver (Vertical louver) may change during transportation. As shown below, lift up the vertical louver lightly, turn it matching with the direction of the plastic coupling rod, insert it into clearance of the extrusion, and then arrange the direction of the vertical louver to the desired direction.

4 Installation

WARNING

- Install the air conditioner securely in a location where the base can sustain the weight adequately. If the strength is not enough, the unit may fall down resulting in injury.
- Carry out the specified installation work to guard against the possibility of high winds and earthquake. If the air conditioner is not installed appropriately, a unit may topple over or fall down, causing an accident.
- If the unit is installed in a small room, observe applied floor area for the unit and take appropriate measures to prevent the refrigerant from exceeding the limit concentration even if it leaks. Consult dealer where you purchased the product to install the unit in a small room. Accumulation of highly concentrated refrigerant may cause a fire or oxygen deficiency accident.
- For simultaneous twin, triple, or double twin system, indoor unit must be installed in the same room. If an indoor unit is installed in the small room, an applied floor area for the unit may not be observed.

CAUTION

- Strictly comply with the following rules to prevent damage of the indoor units and human injury.
- Do not put a heavy article on the indoor unit or let a person get on it. (Even units are packaged)
 - Carry in the indoor unit as it is packaged if possible. If carrying in the indoor unit unpacked by necessity, use buffering cloth or other material not to damage the unit.
 - Carry the package by four or more persons, and do not bundle it with plastic band at positions other than specified.
 - Be sure to take measures to prevent falling at the wall surface and the floor and fix it surely considering prevention of accident of falling because this unit is formed into a thin type. If it is not fixed, a falling accident may occur.
 - After carrying in the indoor unit to the specified place, fix it to the wall and the floor immediately for safety.

External views

(Unit: mm)

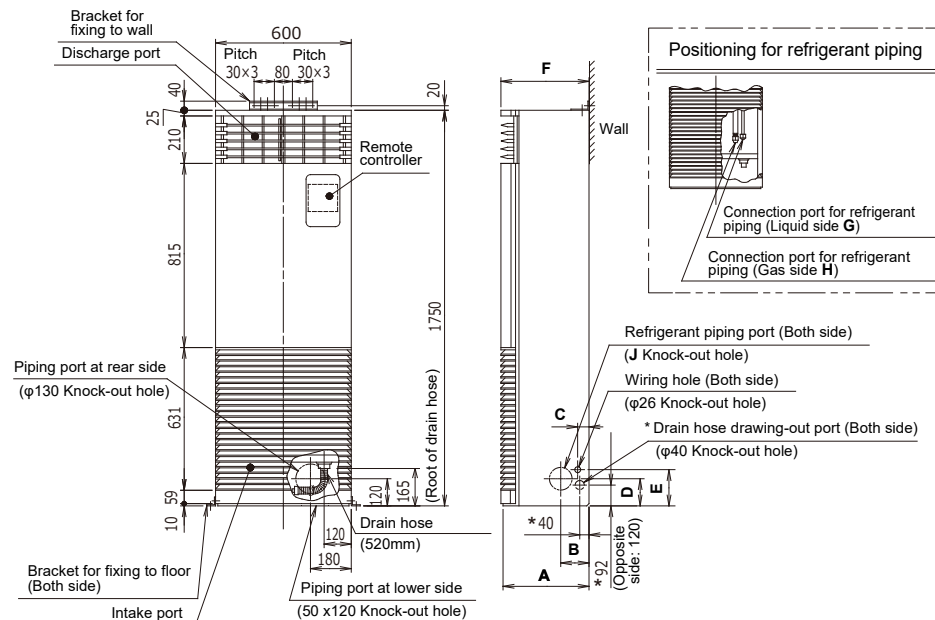

* Drain hose drawing-out port (Both side) is for only RM110 model to RM160.
To connect drain hose on right or left, route it through the knock-out for refrigerant piping on RM56 to RM80 model.

Model RAV-	A	B	C	D	E	F	G	H	J
RM56	200	50	107	132	157	210	φ 6.4	φ 12.7	φ 80
RM80							φ 9.5	φ 15.9	
RM110 to RM160	380	125	50	120	160	390			φ 100

■ Installation of indoor unit

REQUIREMENT

In case of installing the indoor unit to the floor and the wall other than wooden floor and wall, the six anchor bolts (M8 × L50 or longer) are required. Procure them at the local site.

Fixing to the wall surface

Use the attached wall fixing bracket by inverting it at upper side of the unit. Fix the indoor unit to the wall surface using the attached screw bolts, anchor bolts or etc. at two positions. Many holes for fixing the indoor unit to wall surface and for fixing the indoor unit itself are provided on the bracket. Sliding the bracket right and left sides, select a position which can securely fix the indoor unit and then fix it.

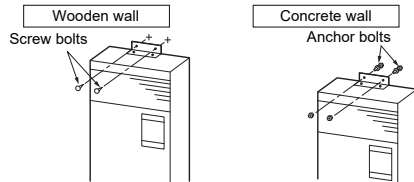

A hole on the wall fixing bracket for the indoor unit is a long hole. Therefore the indoor unit can be fixed at any position keeping clearance from 0 to 50 mm.

As shown below, it is also possible to fix the indoor unit without inverting the bracket. (In this case, keep clearance with length of head of the bolt between the indoor unit and the wall.)

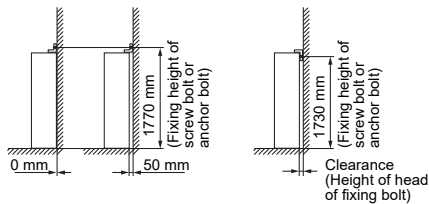

Fixing to the floor

Use the attached floor fixing bracket to fix the lower right and left sides of the indoor unit to the floor.

To fix to the indoor unit, use the side plate screws and use the screw bolts or anchor bolts for fixing to the floor respectively, and then fix the indoor unit at total four positions, two positions for right and left each.

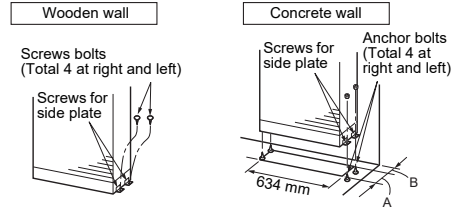

(Unit: mm)

Model	A	B
RM56 to RM80 type	88	30 to 80
RM110 to RM160 type	258	40 to 90

Indoor unit fixing figure

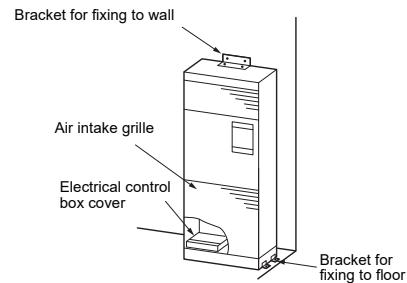

■ Wireless remote controller (Sold separately)

For this indoor unit, a remote controller is built into the unit. To use wireless remote controller, set the remote controller to the Sub remote controller.

The signal receiving unit with wireless remote controller can receive a signal by distance within approx. 7 m. Based upon it, determine a place where the remote controller is operated and the installation place.

- Keep 1 m or more from the devices such as television, stereo. (Disturbance of image or noise may be generated.)
- To prevent a malfunction, select a place where the remote controller is not influenced by a fluorescent light or direct sunlight.
- To individually operate two indoor units installed in the same room, switch setting of signal receiving unit and the wireless remote controller.

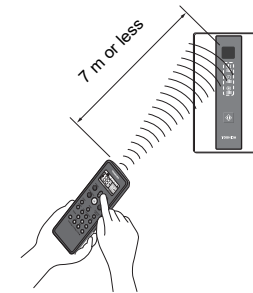

5 Drain piping

⚠ CAUTION

- Following the Installation Manual, perform the drain piping work so that water is properly drained. Apply a heat insulation so as not to cause a dew condensation. Inappropriate piping work may result in water leakage in the room and wet furniture.
- After opening the knockout hole, deburr the edge.
Touching burrs adhered to opening of the knockout hole may cause an injury.
- Following the Installation Manual, perform the drain hose work. Inappropriate drain hose work may result in generation of slime in the drain hose and water leakage in the room.

NOTE

- The drain pipe and drain hose must be sloping downward (at an angle of 1/100 or more), and do not run the pipe up and down (arched shape) or allow it to form traps.
- Be sure to connect the drain hose and drain pipe at the outside of unit and fix them.
- If clearance occurs between piping/wiring and drain hose in opening the knockout hole, apply putty to the clearance.
- Restrict the length of the traversing drain pipe to 20 meters or less. For long pipe, provide support brackets at intervals of 1.5 to 2 meters to prevent flapping. Do not provide any air vents. Otherwise, the drain water will spout, causing water to leak.
- For collective piping, the pipes must be equivalent to VP30 and sloping downward at an angle of 1/100 or more. Provide the indoor drain piping and the refrigerant piping with proper heat insulation. (Foamed polyethylene foam, thickness : 6 mm or more)
- After piping work has been completed, remove the air intake grille and pour water in the drain pan to check water drain and that there is no water leakage from connecting part of the drain hose.
- After check of the water drain, attach the air intake grille as before.
- If the pipe passes through a fire retarding division, apply incombustible material (putty) to the clearance at penetration part.

■ Pipe material, size and heat insulator

The following materials for piping work and insulating process are procured locally.

Pipe material	Hard vinyl chloride pipe (PVC pipe) VP20 (Internal diameter : 20 mm, external diameter : 26 mm)
Heat insulator	Foamed polyethylene foam, thickness: 6 mm or more

■ Connecting drain pipe

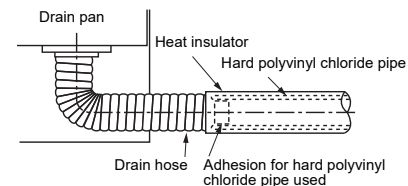

REQUIREMENT

- Using adhesive agent for vinyl chloride, connect the hard vinyl chloride pipes certainly so that water does not leak.
- It requires several hours to dry and harden the adhesive agent.
(Refer to Guide Manual of the adhesive agent.)
In this time, be sure not to apply force to the connecting section with the drain pipes.

Piping method

Drain and refrigerant pipes can be drew out from left, right, back or bottom depending on the installation location. However, drain pipes can be drew out from left only when the refrigerant pipes are drew out from left. The drain hose must be fix to the refrigerant pipe with binding band and installed with gradient of 1/100 or more. The drain hose end connected to the indoor unit must be free from external force.

- Do not route the drain hose and refrigerant pipes over the electrical control box. Condensed water from the pipes may enter the electrical control box and cause malfunction. Exclude RM56 to RM80 models.
- On the RM56 to RM80 models, the drain hose and refrigerant pipes coming out of the electrical control box must be 5 mm apart. If the clearance is less than 5 mm, it will be hard to remove the drip-proof cover and the electrical control box cannot be taken out.

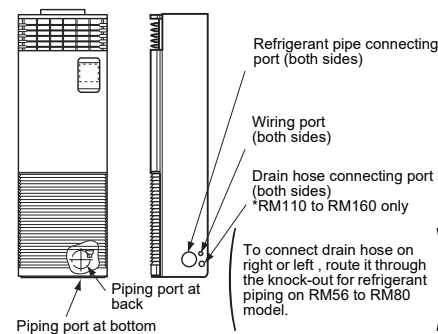

• To connect drain hose on left

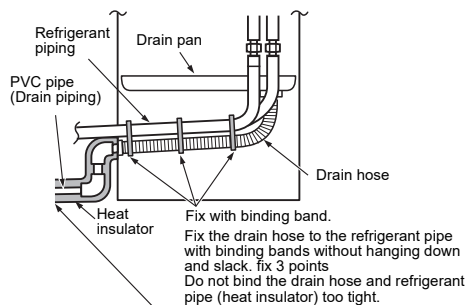

• To connect drain hose on right

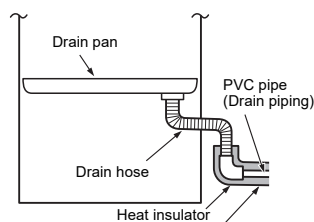

*Connect and fix drain pipe at outside of the unit on site.
 (Install the drain hose with gradient of 1/100 or more to connect it to unit on both left and right sides.)

■ Check the draining

- After piping work has been completed, remove the air intake grille and pour water in the drain pan to check water drain and that there is no water leakage from connecting part of the drain hose.
- After check of the water drain, attach the air intake grille as before.

6 Refrigerant piping

⚠ CAUTION

- Use flare nuts that are included with the unit. Using different flare nuts may cause refrigerant gas leakage.
- After refrigerant piping has been connected, do not turn on the power until gas leakage check is finished. If refrigerant gas leaks, refrigerant leak detection sensor operates and a fan automatically rotates, causing air conditioner not to operate.

■ Refrigerant piping

Use the following item for the refrigerant piping.
Material: Seamless phosphorous deoxidized copper pipe.
 Ø6.35, Ø9.52, Ø12.7 Wall thickness 0.8 mm or more
 Ø15.88 Wall thickness 1.0 mm or more

REQUIREMENT

When the refrigerant pipe is long, provide support brackets at intervals of 2.5 - 3 m to clamp the refrigerant pipe. Otherwise, abnormal sound may be generated.

⚠ CAUTION

IMPORTANT 4 POINTS FOR PIPING WORK

1. Reusable mechanical connectors and flared joints are not allowed indoors. When mechanical connectors are reused indoors, sealing parts shall be renewed. When flared joints are reused indoors, the flare part shall be refabricated.
2. Tight connection (between pipes and unit)
3. Evacuate the air in the connecting pipes by using VACUUM PUMP.
4. Check the gas leakage. (Connected points)

■ Pipe size

Model name	RAV-	RM56 type	RM80, RM110 to RM160 type
Pipe size	Gas side	12.7 mm	15.9 mm
	Liquid side	6.4 mm	9.5 mm

■ Permissible piping length and height difference

They vary according to the outdoor unit. For details, refer to the Installation Manual attached to the outdoor unit.

Flaring

- Cut the pipe with a pipe cutter. Remove burrs completely. Remaining burrs may cause gas leakage.
- Insert a flare nut into the pipe, and flare the pipe. As the flaring sizes of R32 or R410A differ from those of refrigerant R22, the flare tools newly manufactured for R32 or R410A are recommended. However, the conventional tools can be used by adjusting projection margin of the copper pipe.

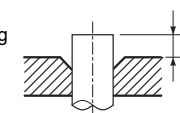

▼ Projection margin in flaring: B (Unit: mm)

Rigid (Clutch type)

Outer dia. of copper pipe	R32 or R410A tool used	Conventional tool used
6.4, 9.5	0 - 0.5	1.0 - 1.5
12.7, 15.9		

▼ Flaring dia. meter size: A (Unit: mm)

Outer dia. of copper pipe	A ⁺⁰ _{-0.4}
6.4	9.1
9.5	13.2
12.7	16.6
15.9	19.7

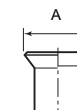

⚠ CAUTION

- Do not scratch the inner surface of the flared part when removing burrs.
- Flare processing under the condition of scratches on the inner surface of flare processing part will cause refrigerant gas leak.
- Check that the flared part is not scratched, deformed, stepped, or flattened, and that there are no chips adhered or other problems, after flare processing.
- Do not apply refrigerating machine oil to the flare surface.

■ Tightening connection

⚠ CAUTION

Do not apply excessive torque. Otherwise, the nut may crack depending on the conditions.

▼ Tightening torque of flare pipe connections

Incorrect connections may cause not only a gas leak, but also a trouble of the refrigeration cycle.

Align the centers of the connecting pipes and tighten the flare nut with your fingers. Then tighten the nut with a spanner and torque wrench as shown in the figure.

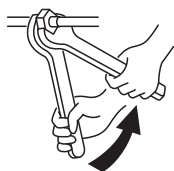

Work using two spanners

REQUIREMENT

Tighten the nut within the specified tightening torque.

Unit: N·m

Outer dia. of copper pipe	Tightening torque
6.4 mm	14 - 18
9.5 mm	34 - 42
12.7 mm	49 - 61
15.9 mm	68 - 82

■ Evacuation

Perform vacuuming from the charge port of valve of the outdoor unit by using a vacuum pump.

For details, follow to the Installation Manual attached to the outdoor unit.

- Do not use the refrigerant sealed in the outdoor unit for evacuation.

REQUIREMENT

For the tools such as charge hose, use those manufactured exclusively for R32 or R410A.

■ Refrigerant amount to be added

For addition of the refrigerant, add refrigerant "R32 or R410A" referring to the attached Installation Manual of outdoor unit.

Use a scale to charge the refrigerant of specified amount.

REQUIREMENT

- Charging an excessive or too little amount of refrigerant causes a trouble of the compressor. Charge the refrigerant of specified amount.
- A personnel who charged the refrigerant should write down the pipe length and the added refrigerant amount in the F-GAS label of the outdoor unit. It is necessary to fix the compressor and refrigeration cycle malfunction.

■ Open the valve fully

⚠ CAUTION

A brazed, welded, or mechanical connection shall be made before opening the valves to permit refrigerant to flow between the refrigerating system parts.

Open the valve of the outdoor unit fully. A 4 mm-hexagonal wrench is required for opening the valve. For details, refer to the Installation Manual attached to the outdoor unit.

■ Gas leak check

Check with a leak detector or soap water whether gas leaks or not, from the pipe connecting section or cap of the valve.

REQUIREMENT

Use a leak detector manufactured exclusively for HFC refrigerant (R32, R410A, R134a).

■ Heat insulation process

Apply heat insulation for the pipes separately at liquid side and gas side.

- For the heat insulation to the pipes at gas side, use the material with heat-resisting temperature 120 °C or higher.
- To use the attached heat insulation pipe, apply the heat insulation to the pipe connecting section of the indoor unit securely without gap.

REQUIREMENT

- Apply the heat insulation to the pipe connecting section of the indoor unit securely up to the root without exposure of the pipe. (The pipe exposed to the outside causes water leak.)
- Insulate the refrigerant pipe in the indoor unit securely up to the point shown in the following figure.

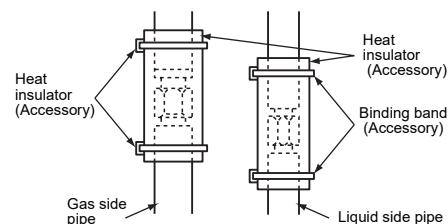

7 Electrical connection

⚠ WARNING

- **Use the specified wires for indoor and outdoor connecting wires. Securely fix them to prevent external forces applied to the terminals from affecting the terminals.**
Incomplete connection or fixation may cause a fire or other trouble.
- **Connect earth wire. (grounding work)**
Incomplete earthing cause an electric shock.
Do not connect earth wires to gas pipes, water pipes, lightning conductor or telephone earth wires.
- **Appliance shall be installed in accordance with national wiring regulations.**
Capacity shortage of power circuit or incomplete installation may cause an electric shock or a fire.
- **Under no circumstances, the power supply wire or the indoor and outdoor connecting wire must not be connected in the middle (Connection using a solderless terminal etc.).**
Connection trouble in the places where the wire is connected in the middle may give rise to smoking and/or a fire.

⚠ CAUTION

- For power supply specifications, follow the Installation Manual of outdoor unit.
- Do not connect 220 – 240 V power to the terminal blocks (Ⓐ, Ⓑ) for control wiring.
Otherwise, the system will fail.
- Do not damage or scratch the conductive core and inner insulator of power and system interconnection wires during peeling them.
- Perform the electric wiring so that it does not come to contact with the high-temperature part of the pipe.
The coating may melt resulting in an accident.
- Be careful of fan operation when the circuit breaker is turned on. If the refrigerant leak detection sensor detects the refrigerant leak, a fan automatically rotates even while an air conditioner stops. Be careful not to be injured by the fan.
- Do not turn on the power of the indoor unit until vacuuming of the refrigerant pipes completes.

■ Wiring connection

Indoor / Outdoor connecting wires specifications

Indoor unit power supplied from outdoor unit

- The outdoor unit power supply patterns vary on models.

Indoor unit power supply	1~50 Hz 220 - 240 V	
Indoor / Outdoor connecting wires*	4 × 1.5 mm ² or more (H07 RN-F or 60245 IEC 66)*	Up to 70 m

*Number of wire × wire size

*Including earth line

Remote controller wiring

For this indoor unit, a remote controller (RBC-AMS55E*) is built into the unit.

"L" (length of remote controller wiring) is 2.5 m.

Remote controller wiring, remote controller inter-unit wiring	Wire size: 2 × 0.5 to 2.0 mm ²	
Total wire length of remote controller wiring and remote controller inter-unit wiring = L + L1 + L2 + ... Ln	In case of wired type only	Up to 500 m
	Two Remote controllers	Up to 300 m
	Two Remote controllers with wireless remote controller	Up to 400 m
Total wire length of remote controller inter-unit wiring = L1 + L2 + ... Ln	Up to 200 m	

⚠ CAUTION

- The remote controller wire and Indoor / Outdoor connecting wires cannot be parallel to contact each other and cannot be stored in the same conduits. If doing so, a trouble may be caused on the control system due to noise or other factor.
- For Floor standing type, remote controller is built in. When the units are used as simultaneous operation system, up to two remote controllers of Master and Sub remote controller can be connected. When there are three remote controllers or more in the system, remove connector connecting to the terminal block (A/B) in the Indoor unit for remote controller other than Master or Sub remote controller. Set the Master and Sub of remote controller according to the separate Installation Manual for remote controller.

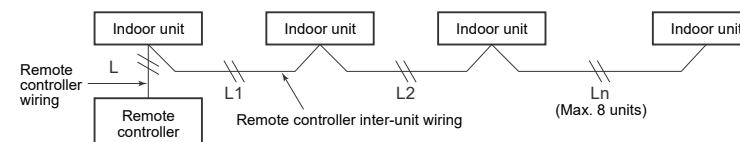

■ Connecting two remote controllers

Adding RBC-AMS55E* (Sold separately)

According to Installation Manual attached to remote controller, set one of two remote controllers to the Sub remote controller.

Adding remote controller other than RBC-AMS55E* (Sold separately)

According to Installation Manual attached to remote controller (Sold separately), set the remote controller to the Sub remote controller. (Keep the built-in remote controller as Master remote controller.)

■ Wiring between indoor unit and outdoor unit

- Figure below shows the wiring connections between the indoor and outdoor units and between the indoor units and remote controller. The wires indicated by the broken lines are provided at the locally.
- Refer to the both indoor and outdoor unit wiring diagrams.
- For details, refer to the Installation Manual for outdoor unit to be connected.

Wiring diagram (Example)

Single operation

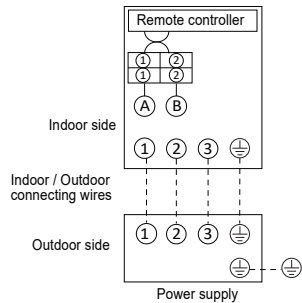

Simultaneous twin operation

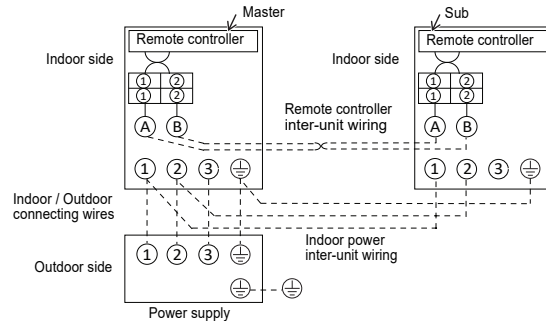

Simultaneous triple and double twin operation

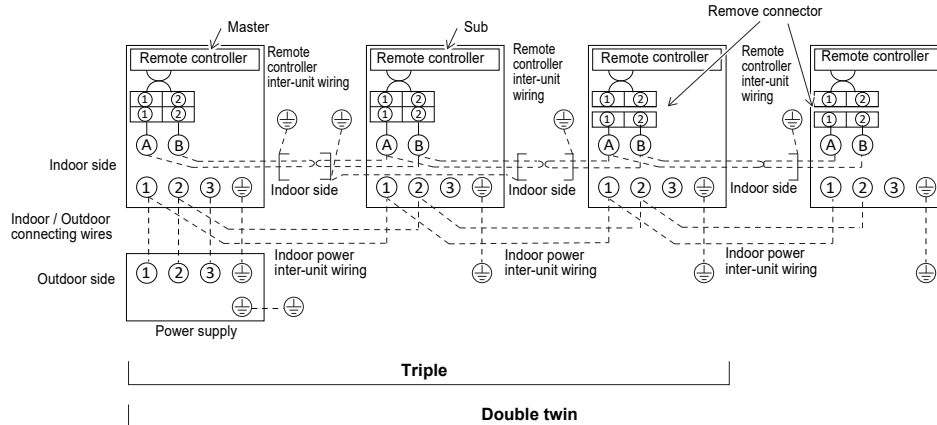

- * Use 2-core shield wire (MVVS 0.5 to 2.0 mm² or more) for the remote controller wiring in the simultaneous triple and simultaneous double twin systems to prevent noise problems. Connect both ends of the shield wire to earth leads.
- * Connect earth wires for each indoor unit in the simultaneous triple and simultaneous double twin systems.

NOTE

- For the simultaneous twin, simultaneous triple and simultaneous double twin connection, attach the crimp terminal to end of the connecting wire.
- Do not connect wire (③ - ③) between header unit and follower unit for simultaneous operation (twin, triple, or double twin). Wiring by mistake cause indoor units not to operate simultaneously and a check code "E18" appears.

■ Wire connection

REQUIREMENT

- Connect the wires matching the terminal numbers. Incorrect connection causes a trouble.
- Pass the wires through the bushing of wiring holes of the indoor unit.
- The low-voltage circuit is provided for the remote controller. (Do not connect the high-voltage circuit)

<How to remove the electrical control box cover>

• RM56, RM80 models

Take off screws (1) and (2) at this side of the electrical control box and remove the drip-proof cover.

Take off screws (3) and (4) at front side of the electrical control box and remove the electrical control box cover.

• RM110 to RM160 models

Take off screws (3) and (4) at front side of the electrical control box and remove the cover of the electrical control box.

(The drip-proof cover is provided to RM56 to RM80 models only.)

<Wiring>

- Draw the wire into the wiring hole (knockout hole).
- Attach a supplied rubber bush to the wiring hole (knockout hole).
- Be sure to fix the connecting wires using two cord clamps as shown in the figure. Do not apply tension on the connecting part of the terminal block.
- Be sure to mount cover of the electrical control box and the drip-proof cover.

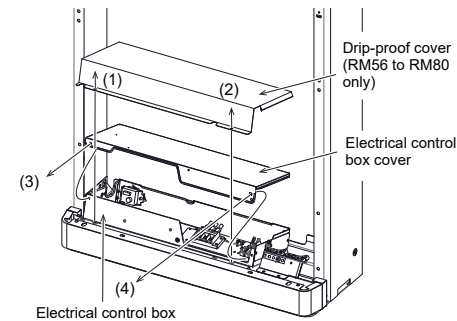

<Positioning of hole for wiring (Knock-out hole)>

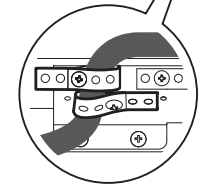
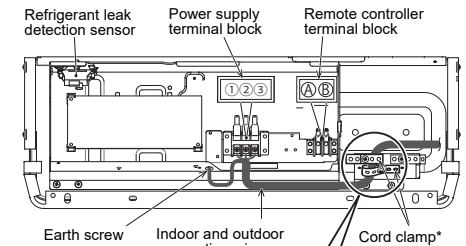
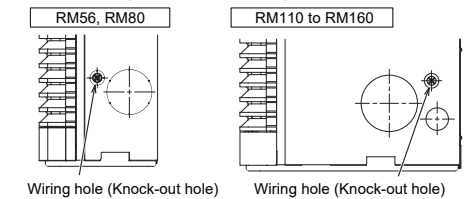

- * Match the cord clamp with size of connecting wires by position of holes on the clamp to hold the wire and fix the cord clamp by screw.
- * Be sure to fix the connecting wires using two cord clamps as shown in the figure.

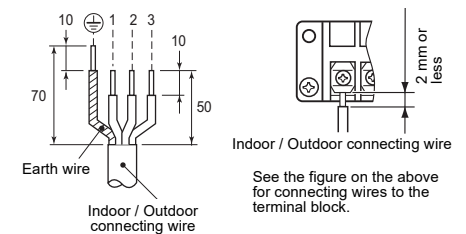

Remote controller wiring

Strip off approx. 9 mm the wire to be connected.

Wiring diagram

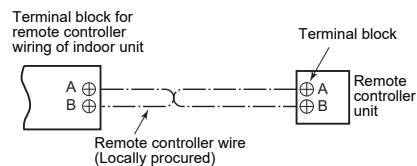

8 Applicable controls

REQUIREMENT

- When you use this air conditioner for the first time, it takes approx. 5 minutes until the remote controller becomes available after power-on. This is normal. **<When power is turned on for the first time after installation>** It takes **approx. 5 minutes** until the remote controller becomes available.

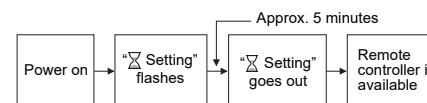

<When power is turned on for the second (or later) time>

It takes **approx. 1 minute** until the remote controller becomes available.

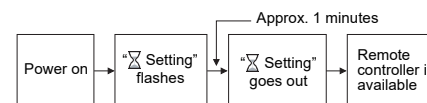

- Normal settings were made when the indoor unit was shipped from factory. Change the indoor unit settings as required.
- Use the built-in remote controller to change the settings.
 - * The settings cannot be changed using the wireless remote controller, simplified wired remote controller, or remote-controller-less system (for central remote controller only).

Basic procedure for changing settings

Change the settings while the air conditioner is not working. **(Stop the air conditioner before making settings.)**

CAUTION

Set only the "Code(DN)" shown in the following table: Do not set any other "Code(DN)". If a "Code(DN)" not listed is set, it may not be possible to operate the air conditioner or other trouble with the product may result.

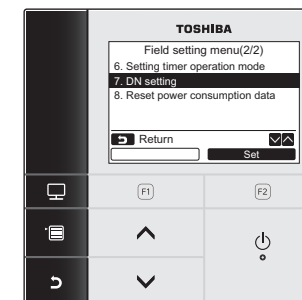

1 Push the [MENU] button to display the menu screen.

2 Push and hold the [MENU] button and the [] button at the same time to display the "Field setting menu".

→Push and hold the buttons for more than 4 seconds.

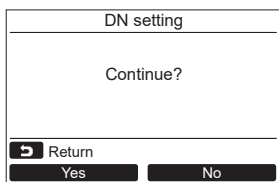
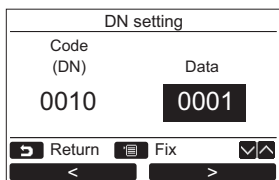
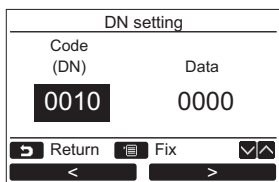

3 Push the [▲ ▲]/[▼ ▼] button to select “7. DN setting” on the “Field setting menu” screen, then push the “Set” [F2] button.

→The fan and louver of the indoor unit operate. When the group control is used, the fan and louver of the selected indoor unit operate.

→Move the cursor to select “Code(DN)” with the “<” [F1] button, then set “Code(DN)” with the [▲ ▲]/[▼ ▼] button.

→Move the cursor to select “Data” with the “>” [F2] button, then set “Data” with the [▲ ▲]/[▼ ▼] button.

4 Push the [MENU] button to set the other Code(DN) and Data. After “Continue?” is displayed on the screen, push the “Yes” [F1] button.

5 Push the “No” [F2] button to finish the setting operation. “Setting” appears on the screen for a while, then the screen returns to the “Field setting menu” screen.

→Pushing the “No” [F2] button displays the unit selection screen when the group control is used. Push the [CANCEL] button on the unit selection screen to finish the setting operation. “Setting” appears on the screen for a while, then the screen returns to the “Field setting menu” screen.

Filter sign setting

According to the installation condition, the filter sign term (Notification of filter cleaning) can be changed. Follow to the basic procedure.

(1 → 2 → 3 → 4 → 5).

- For the “Code (DN)” in Procedure 3, specify [0001].
- For the “Data” in Procedure 3, select the Data of filter sign term from the following table.

Data	Filter sign term
0000	None
0001	150 H (Factory default)
0002	2500 H
0003	5000 H
0004	10000 H

To secure better effect of heating

When it is difficult to obtain satisfactory heating due to installation place of the indoor unit or structure of the room, the detection temperature of heating can be raised. Also use a circulator or other machinery to circulate heat air near the ceiling.

Follow to the basic procedure.

(1 → 2 → 3 → 4 → 5).

- For the “Code (DN)” in Procedure 3, specify [0006].
- For the “Data” in Procedure 3, select the Data of shift value of detection temperature to be set up from the following table.

Data	Detection temperature shift value
0000	No shift (Factory default)
0001	+1 °C
0002	+2 °C
0003	+3 °C
0004	+4 °C
0005	+5 °C
0006	+6 °C

8 °C operation

Pre-heating operation can be set for cold regions where room temperature drops to below zero.

Follow to the basic procedure.

(1 → 2 → 3 → 4 → 5).

- For the “Code (DN)” in Procedure 3, specify [00d1].
- For the “Data” in Procedure.

Data	8 °C Operation setting
0000	None (Factory default)
0001	8 °C Operation setting

Monitor function

The sensor temperature or operational status of indoor unit, outdoor unit, or remote controller can be monitored.

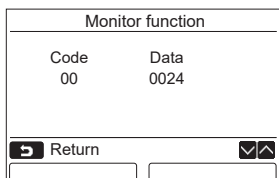

- 1 Push the [MENU] button to display the menu screen.
- 2 Push and hold the [MENU] button and the [▽] button at the same time to display the "Field setting menu".
→ Push and hold the buttons for more than 4 seconds.
- 3 Push the [▲] / [▽] button to select "4. Monitor function" on the "Field setting menu" screen, then push the [Set] button.
→ Push the [▲] / [▽] button to select the code to check data.
- 4 Push the [CANCEL] button to return to the "Field setting menu" screen.

Indoor unit data	
Code	Data name
01	Room temperature (remote controller)
02	Indoor unit intake air temperature (TA)
03	Indoor unit heat exchanger (coil) temperature (TCJ)
04	Indoor unit heat exchanger (coil) temperature (TC)
F3	Indoor unit fan cumulative operating hours (x1 h)
E2	Indoor unit refrigerant leak detection sensor output*

* Display and the contents

- : Sensor function is not available.
- 0000 : Normal
- 0001 : Sensor has been used for 5 years.
- 0002 : Sensor trouble or exceeding the life of the product for sensor
- 0003 : Sensor is detecting refrigerant leak

Outdoor unit data	
Code	Data name
60	Outdoor unit heat exchanger (coil) temperature (TE)
61	Outside air temperature (TO)
62	Compressor discharge temperature (TD)
63	Compressor suction temperature (TS)
65	Heatsink temperature (THS)
6A	Operating current (x1/10)
6D	Outdoor heat exchange (coil) temperature (TL)
F1	Compressor cumulative operating hours (x100 h)

Installing optional parts

When installing optional parts, data setup may be required with remote controller. Be sure to set the data, according to Installation Manual for optional parts.

Group control

Simultaneous twin, triple or double twin system

A combination with an outdoor unit allows simultaneous ON / OFF operation of the indoor units. The following system patterns are available.

- Two indoor units for the twin system
- Three indoor units for the triple system
- Four indoor units for the double-twin system
- For Floor standing type, remote controller is built in the unit. When the units are used as simultaneous operation system, up to two remote controllers as Master and Sub remote controller can be connected. When there are three remote controllers or more in the system, remove connector connecting to the terminal block (A/B) in the Indoor unit for remote controller other than Master or Sub remote controller. Set the remote controllers to the Master and Sub remote controller according to the separate Installation Manual for remote controller.

▼ Twin system

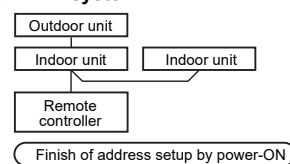

▼ Triple system

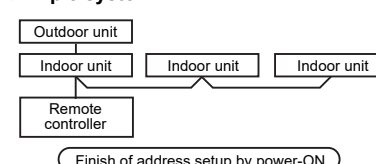

▼ Double twin

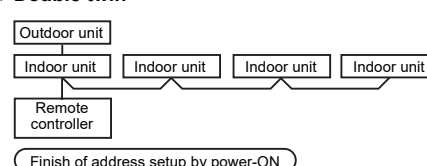

- For wiring procedure and wiring method, follow to the "Electrical connection" in this manual.
- When the power supply has been turned on, the automatic address setup starts and "⊗ setting" that address is being setup flashes on the display part after about 3 minutes. During setup of automatic address, the remote controller operation is not accepted.

Required time up to the finish of automatic addressing is approx. 5 minutes.

Group control for system of multiple units

One remote controller can control maximum 8 indoor units as a group.

▼ Group control in single system

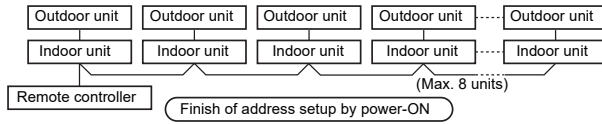

- For wiring procedure and wiring method of the individual line (Identical refrigerant line) system, follow to "Electrical connection".
- Wiring between lines is performed in the following procedure.
Connect the terminal block (A/B) of the indoor unit connected with a remote controller to the terminal blocks (A/B) of other indoor units by wiring the inter-unit wire of the remote controller.
- When the power supply has been turned on, the automatic address setup starts and "X" setting" that address is being setup flashes on the display part after about 3 minutes. During setup of automatic address, the remote controller operation is not accepted.

Required time up to the finish of automatic addressing is approx. 5 minutes.

NOTE

In some cases, it is necessary to change the address manually after setup of the automatic address according to the system configuration of the group control.

- The following mentioned system configuration is a case of complex systems in which systems of the simultaneous twin and simultaneous triple unit is controlled as a group by a remote controller.

(Example) Group control for complex system

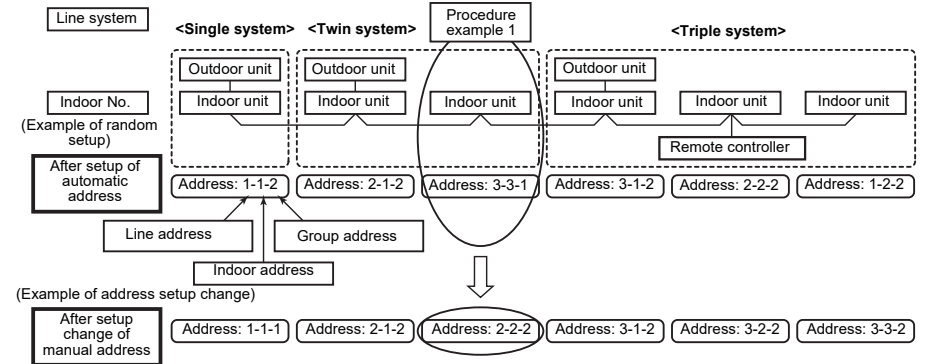

The above address is set by the automatic addressing when the power is turned on. However, line addresses and indoor addresses are set randomly. For this reason, change the setting to match line addresses with indoor addresses.

[Procedure example]

Manual address setup procedure

While the operation stops, change the setup.
(Stop the operation of the unit.)

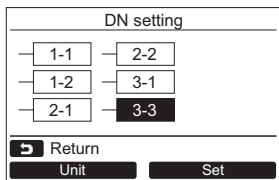
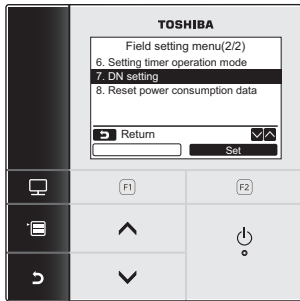

Address is displayed here.

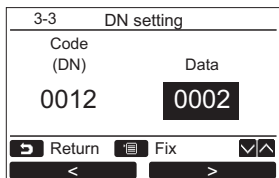
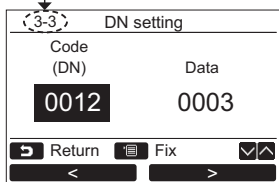

- 1 Push the [MENU] button to display the menu screen.
- 2 Push and hold the [MENU] button and the [v v] button at the same time to display the "Field setting menu".
→Push and hold the buttons for more than 4 seconds.
- 3 Push the [^ ^]/[v v] button to select "7.DN setting" on the "Field setting menu" screen, then push the "Set" [F2] button.
- 4 Push the "Unit" [F1] button to select the indoor unit "3 - 3" to be changed manually.
→The selected unit changes as follows each time the button is pushed:

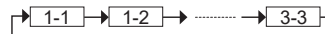

- 5 Push the "Set" [F2] button.
→The setting display for the selected unit appears.
→The fan and louver of the indoor unit operate.
When the group control is used, the fan and louver of the selected indoor unit operate.

Line address change

- Change "Code(DN)" from [0010] to [0012] with the [^ ^]/[v v] button.
- Change "Data" from [0003] to [0002] with the [^ ^]/[v v] button.

Address is displayed here.

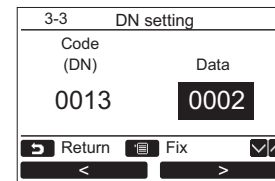
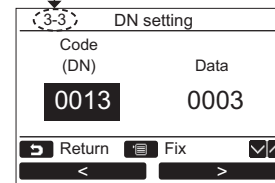

Address is displayed here.

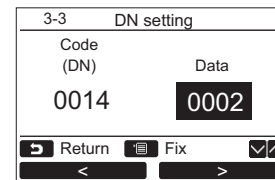
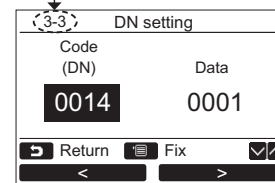

- 6 Push the [MENU] button to set the other Code(DN) and Data. After "Continue?" is displayed on the screen, push the "Yes Yes" [F1] button.

Indoor address change

- Change "Code(DN)" from [0010] to [0013] with the [^ ^]/[v v] button.
- Change "Data" from [0003] to [0002] with the [^ ^]/[v v] button.

- 7 Push the [MENU] button to set the other Code(DN) and Data. After "Continue?" is displayed on the screen, push the "Yes Yes" [F1] button.

Group address change

- Change "Code(DN)" from [0010] to [0014] with the [^ ^]/[v v] button.
- Change "Data" from [0001] to [0002] with the [^ ^]/[v v] button.

- 8 Push the [MENU] button to set the other Code(DN) and Data. After "Continue?" is displayed on the screen, push the "No No" [F2] button to finish the setting operation. "Setting" appears on the screen for a while, then the screen returns to the "Field setting menu" screen.
→Pushing the "No No" [F2] button displays the unit selection screen when the group control is used. Push the [CANCEL] button on the unit selection screen to finish the setting operation. "Setting" appears on the screen for a while, then the screen returns to the "Field setting menu" screen.

9 Test run

■ Before test run

- Before turning on the power supply, carry out the following procedure.
 - 1) By using tester (500 VMΩ), check that resistance of 1 MΩ or more exists between the terminal block 1 to 3 and the earth (grounding).
If resistance of less than 1 MΩ is detected, do not run the unit.
 - 2) Check the valve of the outdoor unit being opened fully.
- To protect the compressor at activation time, leave power-ON for 12 hours or more before operating.

■ Execute a test run

Operate the unit with the remote controller as usual.
For the procedure of the operation, refer to the attached Owner's Manual.
A forced test run can be executed in the following procedure even if the operation stops by thermostat-OFF.
In order to prevent a serial operation, the forced test run is released after 60 minutes have passed and returns to the usual operation.

⚠ CAUTION

- Do not use the forced test run for cases other than the test run because it applies an excessive load to the devices.
- Be careful of fan operation when the circuit breaker is turned on. If the refrigerant leak detection sensor detects the refrigerant leak, a fan automatically rotates even while an air conditioner stops. Be careful not to be injured by the fan.

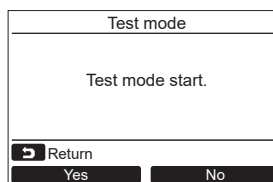
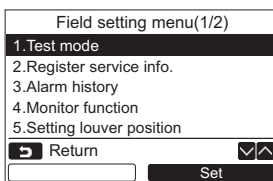
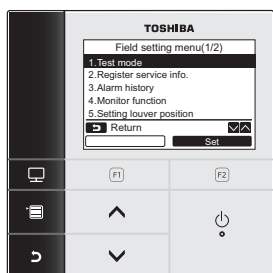

1 Push the [MENU] button to display the menu screen.

2 Push and hold the [MENU] button and the [▽▽] button at the same time to display the "Field setting menu".
→Push and hold the buttons for more than 4 seconds.

3 Push the [▲▲]/[▽▽] button to select "1. Test mode" on the "Field setting menu" screen, then push the [Set] [F2] button.

→Pushing the "Yes" [F1] button sets the test mode and the screen returns to the "Field setting menu" screen.
Push [CANCEL] twice, the screen (2) appears.

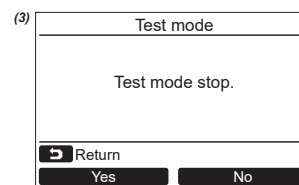
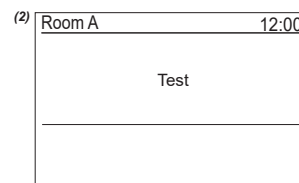
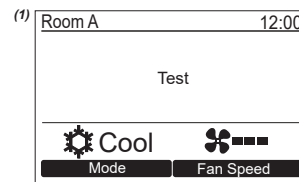

4 Push the [ON / OFF] button to start the test mode. The screen (1) shown in the left appears. (The screen (2) appears when the operation is stopped.)

- Perform the test mode in the "Cool" or "Heat" mode.
- Temperature setting cannot be adjusted during the test mode.
- Check codes are displayed as usual.

5 When the test mode is finished, push the [▲▲]/[▽▽] button to select "1. Test mode" on the "Field setting menu" screen, then push the [Set] [F2] button. The screen (3) appears.

- Pushing the "Yes" [F1] button stops the test mode screen and continues the normal operation.

NOTE

The test mode stops after 60 minutes and the screen returns to the normal / detailed display.

◆ Measures when a check code "E18" appears at the time of simultaneous (twin, triple, or double twin) connection

1 Reconnect the wires between indoor unit and indoor unit correctly.

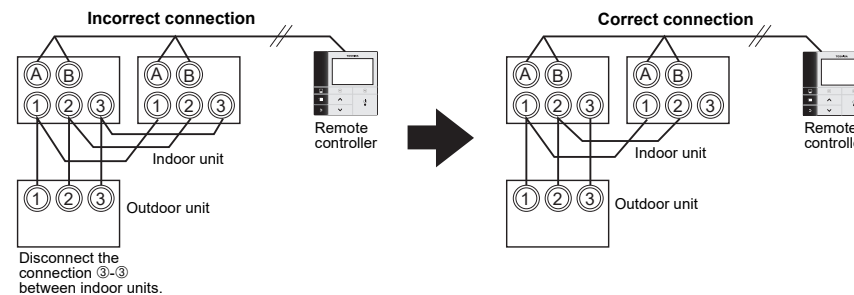

2 Change each indoor unit into correct address.

- Change the address of each indoor unit into correct one according to "Manual address setup procedure" in the previous page when the check code "E18" appears on the remote controller.

10 Maintenance

Be sure to turn off the circuit breaker before maintenance.

NOTE

- Do not use alcohol, benzene, thinner, scouring powder, etc. as those may cause deformation or breakage.
- Do not rub the product with a chemical cloth or remain the cloth made contact with the product for a long time. Doing so may cause the product surface to deteriorate and its paint to come off.

Body of indoor unit

Wipe with a dry, soft cloth.

- If heavily stained, wipe off dirt with a cloth soaked in lukewarm water (40°C or less).

Remote controller

Wipe with a dry, soft cloth.

- Do not use water to wipe the remote controller.
- Be sure to turn on the circuit breaker after maintenance is finished. Leaving the circuit breaker turned off cause a refrigerant leak detection sensor not to operate, and result in failing to detect refrigerant leak.

▼ Cleaning of air filter

"!" (filter sign) appears on the detailed display (not displayed when it is in the normal display mode) to tell the time for cleaning the filter.

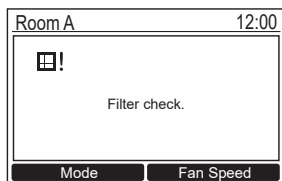
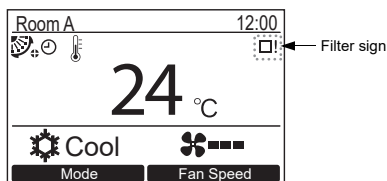

- "Filter check" is displayed on the screen if you start running the air conditioner when "!" (filter sign) appears on the detailed display. Push one of the operation buttons to erase the message or wait for more than 5 seconds until the message disappears.

- 1 Push the [ ON / OFF] button to stop the operation, then turn off the circuit breaker.
- 2 Use a screwdriver to unfasten the screws of the intake grille (two places) to open the intake grille. The screws are designed to stay on the intake grille.

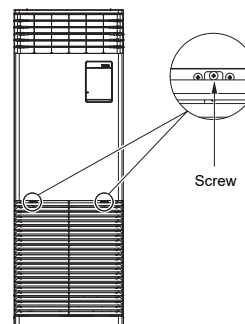



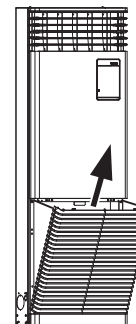



- 3 Take out the air filter.
 - Pull up the air filter toward you.

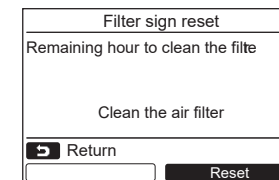

- Cleaning with water or vacuum cleaner
- If dirt is heavy, clean the air filter by tepid water with neutral detergent or water.
- After cleaning with water, dry the air filter sufficiently in a shade place.
- To attach the air filter, insert it into the unit and push it in.

- 4 Close the intake grille and fasten the screws (two places).
- 5 Turn on the circuit breaker, then push the [ ON / OFF] button on the remote controller to start the operation.
- 6 Reset the filter sign



1. Push the [ ^] / [ v] button to select "Filter sign reset" on the menu screen, then push the " Set" / " F2] button.
2. Push the " Reset" / " F2] button.

⚠ CAUTION

- Do not start the air conditioner while leaving air filter removed.
- Reset the filter sign.

▼ Periodic Maintenance

For environmental conservation, it is strongly recommended that the indoor and outdoor units of the air conditioner in use be cleaned and maintained regularly to ensure efficient operation of the air conditioner.

When the air conditioner is operated for a long time, periodic maintenance (once a year) is recommended.

Furthermore, regularly check the outdoor unit for rust and scratches, and remove them or apply rustproof treatment, if necessary.

As a general rule, when an indoor unit is operated for 8 hours or more daily, clean the indoor unit and outdoor unit at least once every 3 months. Ask a professional for this cleaning / maintenance work.

Such maintenance can extend the life of the product though it involves the owner's expense.

Failure to clean the indoor and outdoor units regularly will result in poor performance, freezing, water leakage, and even compressor failure.

▼ Inspection before maintenance

Following inspection must be carried out by a qualified installer or qualified service person.

Parts	Inspection method
Heat exchanger	Access from inspection opening and remove the access panel. Examine the heat exchanger if there is any clogging or damages.
Fan motor	Access from inspection opening and check if any abnormal noise can be heard.
Fan	Access from inspection opening and remove the access panel. Examine the fan if there are any waggles, damages or adhesive dust.
Filter	Go to installed location and check if there are any stains or breaks on the filter.
Drain pan	Access from inspection opening and remove the access panel. Check if there is any clogging or drain water is polluted.
Refrigerant leak detection sensor	Open the intake grille and E-BOX and check if there are any troubles on sensor's appearance or its connector is connected securely.

▼ Maintenance List

Part	Unit	Check (visual / auditory)	Maintenance
Heat exchanger	Indoor / outdoor	Dust / dirt clogging, scratches	Wash the heat exchanger when it is clogged.
Fan motor	Indoor / outdoor	Sound	Take appropriate measures when abnormal sound is generated.
Filter	Indoor	Dust / dirt, breakage	<ul style="list-style-type: none"> • Wash the filter with water when it is contaminated. • Replace it when it is damaged.
Fan	Indoor	<ul style="list-style-type: none"> • Vibration, balance • Dust / dirt, appearance 	<ul style="list-style-type: none"> • Replace the fan when vibration or balance is terrible. • Brush or wash the fan when it is contaminated.
Air intake / discharge grilles	Indoor / outdoor	Dust / dirt, scratches	Fix or replace them when they are deformed or damaged.
Drain pan	Indoor	Dust / dirt clogging, drain contamination	Clean the drain pan and check the downward slope for smooth drainage.
Ornamental panel, louvers	Indoor	Dust / dirt, scratches	Wash them when they are contaminated or apply repair coating.
Exterior	Outdoor	<ul style="list-style-type: none"> • Rust, peeling of insulator • Peeling / lift of coat 	Apply repair coating.
Refrigerant leak detection sensor	Indoor	<ul style="list-style-type: none"> • Is ⚠ (Check indicator) on the remote controller flashing? • Does check code of J29, J30, or J31 appear on the remote controller? 	Contact the service man to have the refrigerant leak detection sensor checked.

11 Troubleshooting

Confirmation and check

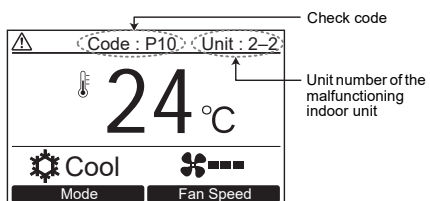

When a trouble has occurred in the air conditioner, the check code and the unit number of the indoor unit appear on the display of the remote controller.

* The check code appears only while the unit is running.

Push the [MONITOR] button or [CANCEL] button to display the check information screen.

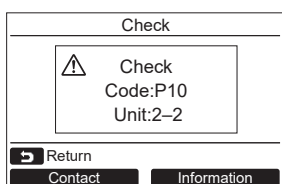

While the check information screen appears:
Push the "Contact" [F1] button to display the contact number for service.
Push the "Information" [F2] button to display the model name and serial number of the unit.

Check codes and parts to be checked

Remote controller display	Wireless remote controller Sensor block display of receiving unit		Main defective parts	Judging device	Parts to be checked / trouble description	Air conditioner status
	Indication	Operation Timer Ready GR GR OR				
E01	● ● ●		No header remote controller Remote controller communication trouble	Remote controller	Incorrect remote controller setting --- The header remote controller has not been set (including two remote controllers). No signal can be received from the indoor unit.	*
E02	● ● ●		Remote controller transmission trouble	Remote controller	Indoor / outdoor connecting wires, indoor P.C. board, remote controller --- No signal can be sent to the indoor unit.	*
E03	● ● ●		Indoor unit-remote controller regular communication trouble	Indoor	Remote controller, network adapter, indoor P.C. board --- No data is received from the remote controller or network adapter.	Auto-reset
E04	● ● ●		Indoor unit-outdoor unit serial communication trouble IPDU-CDB communication trouble	Indoor	Indoor / outdoor connecting wires, indoor P.C. board, outdoor P.C. board --- Serial communication trouble between indoor unit and outdoor unit	Auto-reset
E08	● ● ●		Duplicated indoor addresses ★	Indoor	Indoor address setting trouble --- The same address as the self-address was detected.	Auto-reset
E09	● ● ●		Duplicated header remote controllers	Remote controller	Remote controller address setting trouble --- Two remote controllers are set as header in the double-remote controller control. (* The header indoor unit stops raising alarm and follower indoor units continue to operate.)	*
E10	● ● ●		CPU-CPU communication trouble	Indoor	Indoor P.C. board --- Communication trouble between main MCU and motor microcomputer MCU	Auto-reset
E11	● ● ●		Communication trouble between Application control kit and Indoor unit	Indoor	Communication trouble between Application control kit and Indoor unit	Entire stop
E18	● ● ●		Header unit follower unit regular communication trouble	Indoor	Indoor P.C. board --- Regular communication is not possible between header and follower indoor units or between twin header (main) and follower (sub) units.	Auto-reset
E31	● ● ●		IPDU communication trouble	Outdoor	Communication trouble between IPDU and CDB	Entire stop
F01	● ● ●	ALT	Indoor unit heat exchanger sensor (TCJ) trouble	Indoor	Heat exchanger sensor (TCJ), indoor P.C. board --- Open-circuit or short-circuit of the heat exchanger sensor (TCJ) was detected.	Auto-reset
F02	● ● ●	ALT	Indoor unit heat exchanger sensor (TC) trouble	Indoor	Heat exchanger sensor (TC), indoor P.C. board --- Open-circuit or short-circuit of the heat exchanger sensor (TC) was detected.	Auto-reset
F04	● ● ●	ALT	Outdoor unit discharge temp. sensor (TD) trouble	Outdoor	Outdoor temp. sensor (TD), outdoor P.C. board --- Open-circuit or short-circuit of the discharge temp. sensor was detected.	Entire stop
F06	● ● ●	ALT	Outdoor unit temp. sensor (TE / TS) trouble	Outdoor	Outdoor temp. sensors (TE / TS), outdoor P.C. board --- Open-circuit or short-circuit of the heat exchanger temp. sensor was detected.	Entire stop
F07	● ● ●	ALT	TL sensor trouble	Outdoor	TL sensor may be displaced, disconnected or short-circuited.	Entire stop
F08	● ● ●	ALT	Outdoor unit outside air temp. sensor trouble	Outdoor	Outdoor temp. sensor (TO), outdoor P.C. board --- Open-circuit or short-circuit of the outdoor air temp. sensor was detected.	Operation continued
F10	● ● ●	ALT	Indoor unit room temp. sensor (TA) trouble	Indoor	Room temp. sensor (TA), indoor P.C. board --- Open-circuit or short-circuit of the room temp. sensor (TA) was detected.	Auto-reset

Remote controller display	Wireless remote controller Sensor block display of receiving unit		Main defective parts	Judging device	Parts to be checked / trouble description	Air conditioner status
	Operation Timer Ready GR GR OR	Flashing				
F12	⊙ ⊙ ○	ALT	TS sensor trouble	Outdoor	TS sensor may be displaced, disconnected or short-circuited.	Entire stop
F13	⊙ ⊙ ○	ALT	Heat sink sensor trouble	Outdoor	Abnormal temperature was detected by the temp. sensor of the IGBT heat sink.	Entire stop
F15	⊙ ⊙ ○	ALT	Temp. sensor connection trouble	Outdoor	Temp. sensor (TE / TS) may be connected incorrectly.	Entire stop
F29	⊙ ⊙ ●	SIM	Indoor unit, other P.C. board trouble	Indoor	Indoor P.C. board --- EEPROM trouble	Auto-reset
F31	⊙ ⊙ ○	SIM	Outdoor unit P.C. board	Outdoor	Outdoor P.C. board ---- In the case of EEPROM trouble.	Entire stop
H01	● ⊙ ●		Outdoor unit compressor breakdown	Outdoor	Current detect circuit, power voltage --- Minimum frequency was reached in the current releasing control or short-circuit current (I _{dc}) after direct excitation was detected	Entire stop
H02	● ⊙ ●		Outdoor unit compressor lock	Outdoor	Compressor circuit --- Compressor lock was detected.	Entire stop
H03	● ⊙ ●		Outdoor unit current detect circuit trouble	Outdoor	Current detect circuit, outdoor unit P.C. board --- Abnormal current was detected in AC-CT or a phase loss was detected.	Entire stop
H04	● ⊙ ●		Case thermostat operation	Outdoor	Malfunction of the case thermostat	Entire stop
H06	● ⊙ ●		Outdoor unit low-pressure system trouble	Outdoor	Current, high-pressure switch circuit, outdoor P.C. board --- Pressure sensor trouble was detected or low-pressure protective operation was activated.	Entire stop
J29	● ⊙ ⊙	SIM	Refrigerant leak detection sensor trouble	Indoor	A trouble or open-short-circuit was detected by output of refrigerant leak detection sensor.	Operation continued
J30	● ⊙ ⊙	SIM	Refrigerant leak detection	Indoor	Refrigerant leak was detected by refrigerant leak detection sensor.	Entire stop
J31	● ⊙ ⊙	SIM	Refrigerant leak detection sensor exceeding its life of the product	Indoor	In the case of refrigerant leak detection sensor exceeding its life of the product.	Operation continued
L03	⊙ ● ⊙	SIM	Duplicated header indoor units ★	Indoor	Indoor address setting trouble --- There are two or more header units in the group.	Entire stop
L07	⊙ ● ⊙	SIM	Group line in individual indoor unit ★	Indoor	Indoor address setting trouble --- There is at least one group-connected indoor unit among individual indoor units.	Entire stop
L08	⊙ ● ⊙	SIM	Indoor group address not set ★	Indoor	Indoor address setting trouble --- Indoor address group has not been set.	Entire stop
L09	⊙ ● ⊙	SIM	Indoor unit capacity not set	Indoor	Indoor unit capacity has not been set.	Entire stop
L10	⊙ ○ ⊙	SIM	Outdoor unit P.C. board	Outdoor	In the case of outdoor P.C. board jumper wire (for service) setting trouble	Entire stop
L20	⊙ ○ ⊙	SIM	LAN communication trouble	Network adapter central control	Address setting, central control remote controller, network adapter --- Duplication of address in central control communication	Auto-reset
					Other outdoor unit trouble	Entire stop
L29	⊙ ○ ⊙	SIM	Other outdoor unit trouble	Outdoor	1) Communication trouble between IPDU MCU and CDB MCU	Entire stop
					2) Abnormal temperature was detected by the heat sink temp. sensor in IGBT.	Entire stop
L30	⊙ ○ ⊙	SIM	Abnormal external input into indoor unit (interlock)	Indoor	External devices, outdoor unit P.C. board --- Abnormal stop due to incorrect external input into CN80	Entire stop
L31	⊙ ○ ⊙	SIM	Phase sequence trouble, etc.	Outdoor	Power supply phase sequence, outdoor unit P.C. board --- Abnormal phase sequence of the 3-phase power supply	Operation continued (thermostat OFF)

Remote controller display	Wireless remote controller Sensor block display of receiving unit		Main defective parts	Judging device	Parts to be checked / trouble description	Air conditioner status
	Operation Timer Ready GR GR OR	Flashing				
P01	● ⊙ ⊙	ALT	Indoor unit fan trouble	Indoor	Indoor fan motor, indoor P.C. board --- Indoor AC fan trouble (fan motor thermal relay activated) was detected.	Entire stop
P03	⊙ ● ⊙	ALT	Outdoor unit discharge temp. trouble	Outdoor	A trouble was detected in the discharge temp. releasing control.	Entire stop
P04	⊙ ● ⊙	ALT	Outdoor unit high-pressure system trouble	Outdoor	High-pressure switch --- The IOL was activated or an trouble was detected in the high-pressure releasing control using the TE.	Entire stop
P05	⊙ ● ⊙	ALT	Open phase detected	Outdoor	The power wire may be connected incorrectly. Check open phase and voltages of the power supply.	Entire stop
P07	⊙ ● ⊙	ALT	Heat sink overheat	Outdoor	Abnormal temperature was detected by the temp. sensor of the IGBT heat sink.	Entire stop
P10	● ⊙ ⊙	ALT	Indoor unit water overflow detected	Indoor	Drain pipe, clogging of drainage, float switch circuit, indoor P.C. board --- Drainage is out of order or the float switch was activated.	Entire stop
P12	● ⊙ ⊙	ALT	The fan trouble of the indoor unit	Indoor	Abnormal operation of the indoor fan motor, indoor P.C. board, or indoor DC fan (over current or lock, etc.) is detected.	Entire stop
P15	⊙ ● ⊙	ALT	Gas leakage detected	Outdoor	There may be gas leakage from the pipe or connecting part. Check for gas leakage.	Entire stop
P19	⊙ ● ⊙	ALT	4-way valve trouble	Outdoor (Indoor)	4-way valve, indoor temp. sensors (TC / TCJ) --- A trouble was detected due to temperature drop of the indoor unit heat exchanger sensor when heating.	Auto-reset
P20	⊙ ● ⊙	ALT	High-pressure protective operation	Outdoor	High-pressure protection	Entire stop
P22	⊙ ● ⊙	ALT	Outdoor unit fan trouble	Outdoor	Outdoor unit fan motor, outdoor unit P.C. board --- A trouble (overcurrent, locking, etc.) was detected in the outdoor unit fan drive circuit.	Entire stop
P26	⊙ ● ⊙	ALT	Outdoor unit inverter ldc activated	Outdoor	IGBT, outdoor unit P.C. board, inverter wiring, compressor --- Short-circuit protection for compressor drive circuit devices (G-Tr / IGBT) was activated.	Entire stop
P29	⊙ ● ⊙	ALT	Outdoor unit position trouble	Outdoor	Outdoor unit P.C. board, high-pressure switch --- Compressor motor position trouble was detected.	Entire stop
P31	⊙ ● ⊙	ALT	Other indoor unit trouble	Indoor	Another indoor unit in the group is raising an alarm.	Entire stop
					E03/L07/L03/L08 alarm check locations and trouble description	Auto-reset

○ : Lighting ⊙ : Flashing ● : OFF ★ : The air conditioner automatically enters the auto-address setting mode.
 ALT: When two LEDs are flashing, they flash alternately. SIM: When two LEDs are flashing, they flash in synchronization.
 Receiving unit display OR: Orange GR: Green

APPENDIX

■ Minimum floor area: A_{min} (m²)

When an outdoor unit using R32 refrigerant is combined with this indoor unit, do not install the indoor unit in a poorly ventilated space that is smaller than the minimum floor area (A_{min}).

For refrigerant quantity, refer to Fluorinated Greenhouse Gases label on the outdoor unit.

For the minimum floor area (A_{min}) of this indoor unit, refer to table below.

Total refrigerant quantity M (kg)	Floor standing unit A_{min} (m ²)	Total refrigerant quantity M (kg)	Floor standing unit A_{min} (m ²)	
0.90	No requirements	5.10	12.85	
1.00		5.20	13.10	
1.10		5.30	13.35	
1.20		5.40	13.60	
1.30		5.50	13.85	
1.40		5.60	14.10	
1.50		5.70	14.36	
1.60		5.80	14.61	
1.70		5.90	14.86	
1.80		6.00	15.11	
1.84		4.64	6.10	15.36
1.90		4.79	6.20	15.62
2.00		5.04	6.30	15.87
2.10		5.29	6.40	16.12
2.20	5.54	6.50	16.37	
2.30	5.80	6.60	16.62	
2.40	6.05	6.70	16.87	
2.50	6.30	6.80	17.13	
2.60	6.55	6.90	17.38	
2.70	6.80	7.00	17.63	
2.80	7.05	7.10	17.88	
2.90	7.31	7.20	18.13	
3.00	7.56	7.30	18.38	
3.10	7.81	7.40	18.64	
3.20	8.06	7.50	18.89	
3.30	8.31	7.60	19.14	
3.40	8.57	7.70	19.39	
3.50	8.82	7.80	19.64	
3.60	9.07	7.90	19.90	
3.70	9.32	8.00	20.15	
3.80	9.57	8.10	20.40	
3.90	9.82	8.20	20.65	
4.00	10.08	8.30	20.90	
4.10	10.33	8.40	21.15	
4.20	10.58	8.50	21.41	
4.30	10.83	8.60	21.66	
4.40	11.08	8.70	21.91	
4.50	11.33	8.80	22.16	
4.60	11.59	8.90	22.41	
4.70	11.84	9.00	22.66	
4.80	12.09	-	-	
4.90	12.34	-	-	
5.00	12.59	-	-	

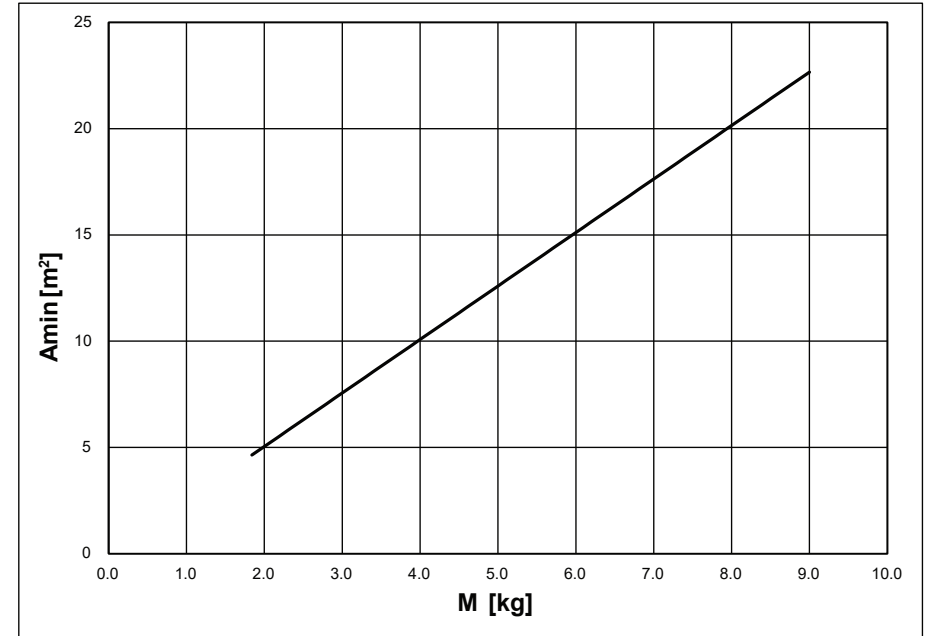

Toshiba Carrier Corporation

336 TADEHARA, FUJI-SHI, SHIZUOKA-KEN 416-8521 JAPAN

EB99832901