

Disc 480 Connect



IK10 IP20

220-240V~, 50/60Hz

Connect
SG Connect
Commissioning

Connect
SG Connect
User

Range: 10m in open air

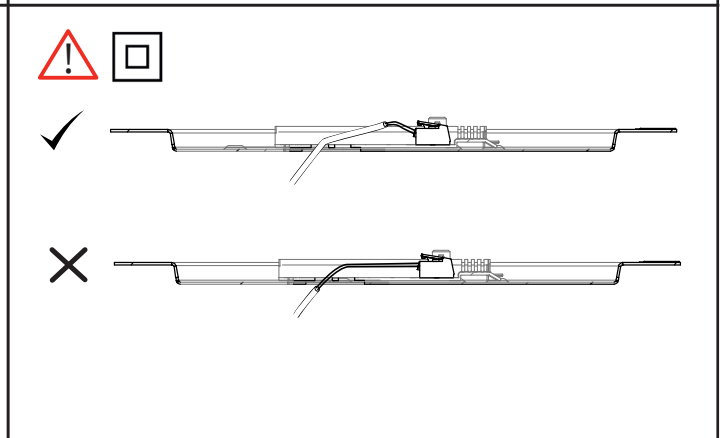
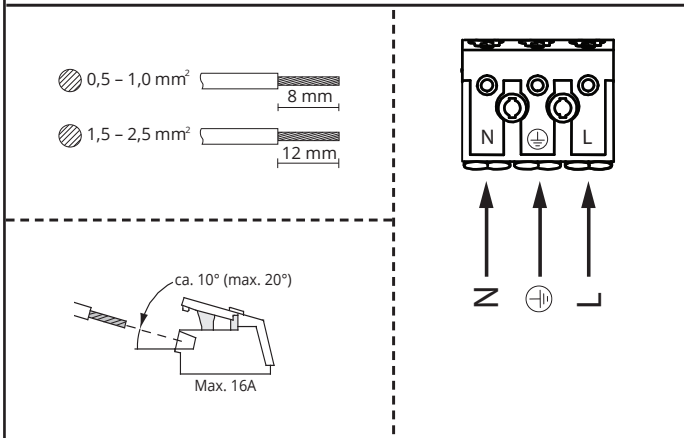
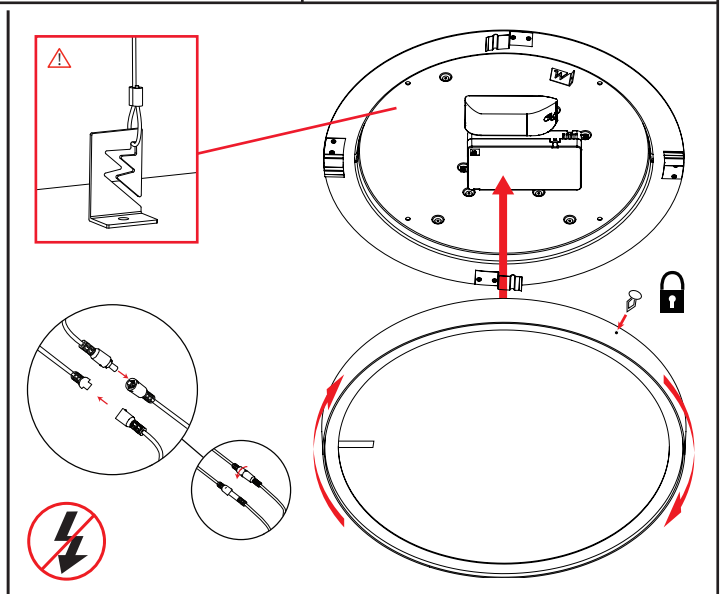
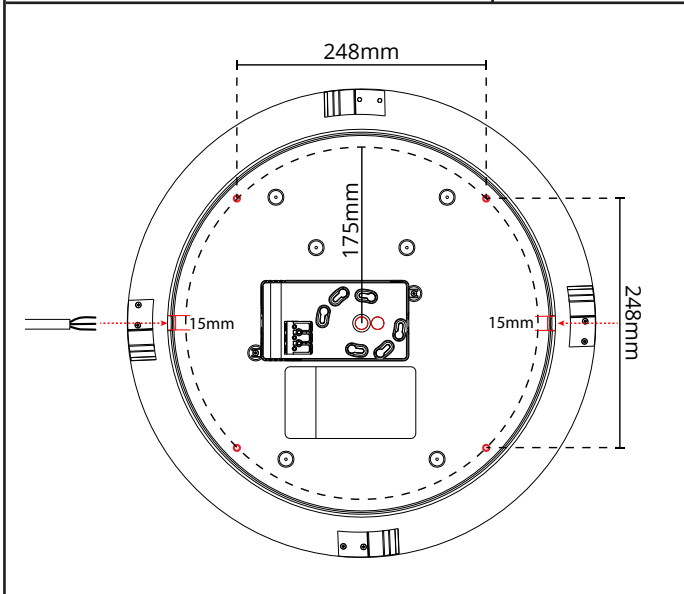

NORWAY
SG Armaturen AS
Skytterheia 25
N-4790 Lillesand

SWEDEN
SG Armaturen AB
Tel: +46 31 81 71 10
info@sg-ab.se
www.sg-ab.se

GERMANY
SG Leuchten GmbH
Tel: +49 40 23 99 44 59
info@sg-leuchten.de
www.sg-leuchten.de

FRANCE
SG Lighting SA/NV
Tel: +33(0) 4 94 93 00 00
info.france@sglighting.fr
www.sglighting.net

SWITZERLAND
SG Leuchten SA
Tel: +41 44 868 20 00
info@sg-leuchten.ch
sg-leuchten.ch

INTERNATIONAL
SG Lighting Co Ltd.
Tel: +86 769 88 49 20 88
cindy@sgdgc.com
www.sg-as.com

Tel: +47 37 50 03 00
firmapost@sg-as.no
www.sg-as.no

DENMARK
SG Armaturen A/S
Tel: +45 70 70 72 13
info@sg-as.dk
www.sg-as.dk

UNITED KINGDOM
SG Lighting LTD
Tel: +47 37 50 03 00
info@sglighting.co.uk
www.sglighting.co.uk

BENELUX
SG Lighting SA/NV
Tel: +32(0) 15 20 72 71
info.benelux@sglighting.net
www.sglighting.net

FINLAND
SG Armaturen Oy
Tel: +358 02 07 30 39 60
info@sg-oy.fi
www.sg-oy.fi

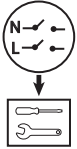

NO: Skru av strømmen før montering.
DK: Sluk for strømmen inden montering.
SE: Stäng av strømmen innan montering.
EN: Turn off power before installing.
FR: Couper le courant avant l'installation.
NL: Stroom uitschakelen voor u het toestel installeert.
DE: Vor Installationsarbeiten den Strom abschalten.
FI: Sammuta virta ennen kytkemistä

7: Non-replaceable light source



3: Replaceable control gear by a professional

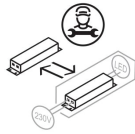

NO: Kan kun installeres og vedlikeholdes av en registrert installasjonsvirksomhet.
DK: Må kun installeres og vedligeholdes af uddannet elektriker.
SE: Skall installeras och underhållas av behörig elektriker.
EN: Only to be installed and maintained by an authorized electrician.
FR: Doit être installé et maintenu par un électricien qualifié.
NL: Mag alleen geïnstalleerd en onderhouden worden door een bevoegde elektricien.
DE: Dieses Produkt darf nur durch autorisiertes Personal (z.B. Elektro-Installateur) angeschlossen, in Betrieb genommen und gewartet werden.
FI: Asentaa ja huoltaa saa vain valtuutettu sähköasentaja



NO: Husk å overholde lokale forskrifter: lever elektrisk utstyr som ikke fungerer til din miljøstasjon. Emballasjen er resirkulerbar. Kast emballasjen på en miljøvennlig måte.
DK: Husk at overholde lokale regler: aflever elektrisk udstyr, der ikke fungerer, til din miljøstation. Emballagen kan genbruges. Bortskaf emballagen på en miljøvenlig måde.
SE: Kom ihåg att följa lokala bestämmelser: överlämna elektronisk utrustning som inte fungerar till din miljöstation. Förpackningen kan återvinnas. Kassera förpackningen på ett miljövänligt sätt.
EN: Please remember to respect the local regulations: hand in the non-working electrical equipment to an appropriate waste disposal center. The packaging material is recyclable. Dispose of the packaging in an environmentally friendly manner.
FR: Veuillez à respecter les réglementations locales : déposez le matériel électrique hors d'usage dans une déchetterie. L'emballage peut être recyclé. Éliminez l'emballage de manière écologique.
NL: Denk eraan om de plaatselijke voorschriften na te leven: lever elektrische apparatuur die niet meer werkt in bij uw milieustation. De verpakking kan worden gerecycled. Verwijder de verpakking op een milieuvriendelijke manier.
DE: Befolgen Sie die örtlichen Vorschriften: Geben Sie Elektroaltgeräte bei einem Entsorger vor Ort ab. Die Verpackung lässt sich recyceln. Entsorgen Sie die Verpackung auf umweltfreundliche Weise.
FI: Muista noudattaa paikallisia määräyksiä: toimita rikkiäisest sähkölaitteest sähkö- ja elektroniikkaromun keräyspisteeseen. Pakkaus on kierrätettävä. Hävitä pakkaus ympäristöystävällisellä tavalla.



NO: Drivren må være strømløs når LED panelet kobles til. Ellers kan LED panelet og drivren skades, og garantien vil ikke gjelde.
DA: Sørg for, at der ikke er tændt for drivren, før LED-panelet tilsluttes. Ellers kan LED-panelet og drivren blive beskadiget, og garantien bliver ugyldig.
SV: Kontrollera att drivern inte är strömsatt innan LED-panelen ansluts. Annars kan LED-panelen och drivern skadas och garantin bli ogiltig.
EN: Make sure driver is not powered before LED panel is connected. Otherwise LED panel and driver could be damaged and warranty will be void.
FR: Vérifiez que le driver est hors tension avant de connecter le panneau à LED. Autrement le panneau à LED et le driver pourraient être endommagés et la garantie ne serait plus valable.
NL: Zorg dat u het ledpaneel aansluit voordat u de driver inschakelt. Anders kunnen het ledpaneel en de driver beschadigd raken en vervalt de garantie.
DE: Darauf achten, dass der Treiber vor dem Anschluss des LED-Panels von der Stromversorgung getrennt ist. Andernfalls können LED-Panel und Treiber beschädigt werden, und die Garantie erlischt.
FI: Varmista, että ohjaimen ei ole kytketty virtaa ennen LED-paneelin liittämistä. Jos virta on kytketty, LED-paneeli ja ohjain voivat vaurioitua, ja takuu mitätöityy.



NO: Hvis armaturens ytre ledning er skadet, skal den byttes av produsenten eller lignende kvalifisert personell.
DK: Hvis armaturets eksterne kabel er beskadiget, skal det udskiftes af producenten eller lignende kvalificeret personale.
SE: Om armaturens externa kabel är skadat måste den bytas ut av tillverkaren eller liknande kvalificerad personal.
EN: If the external flexible cable or cord of this luminaire is damaged, it shall be exclusively replaced by the manufacturer or his service agent or a similar qualified person in order to avoid a hazard.
FR: Si le câble externe de l'armature est endommagé, il doit être remplacé par le fabricant ou par du personnel disposant de qualifications similaires.
NL: Als de externe kabel van de armatuur beschadigd is, moet deze worden vervangen door de fabrikant of vergelijkbaar gekwalificeerd personeel.
DE: Wenn das externe Kabel der Leuchte beschädigt ist, muss es vom Hersteller oder von Fachpersonal ausgetauscht werden.
FI: Mikäli valaisimen ulkoinen kaapeli on vaurioitunut, valmistajan tai vastaavan pätevän henkilön on vaihdettava se.

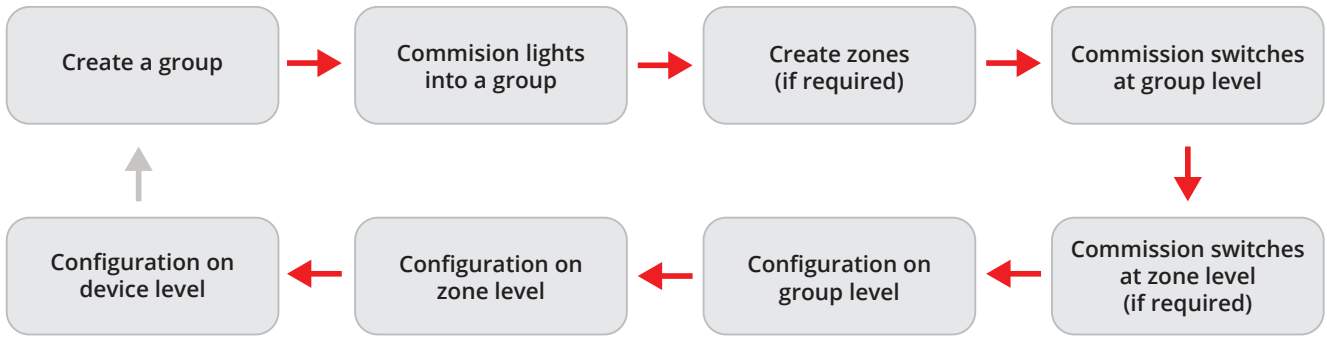

1 Login

1.1

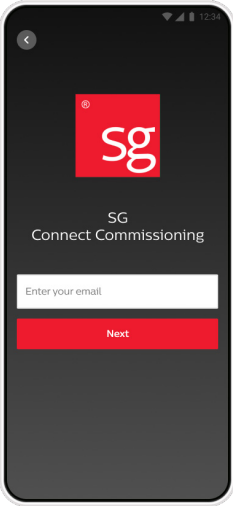

1.2

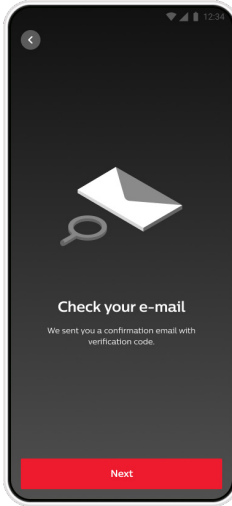

1.3

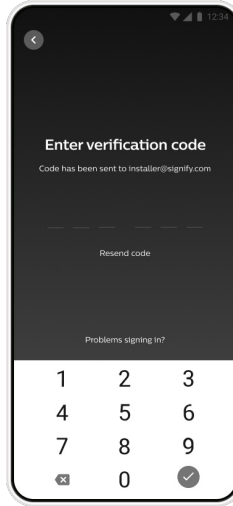

1.4

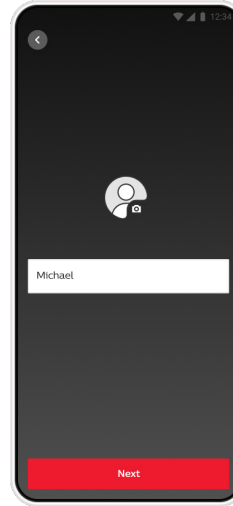

2 Create Group

2.1

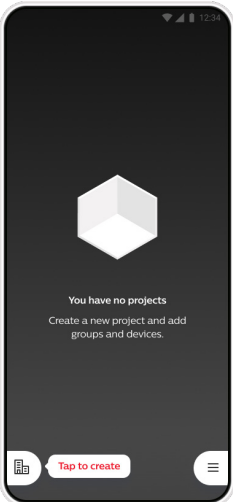

2.2

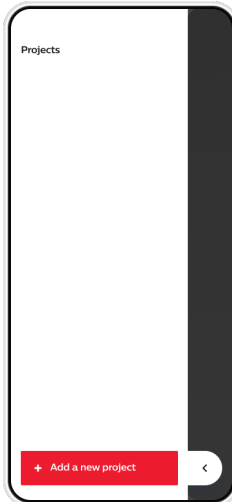

2.3

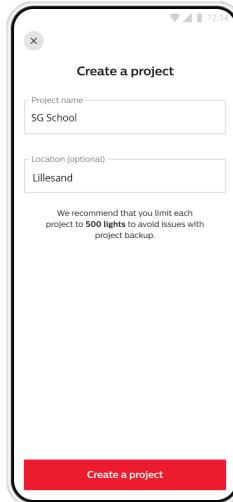

2.4

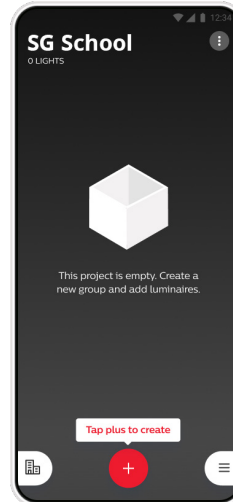

2.5

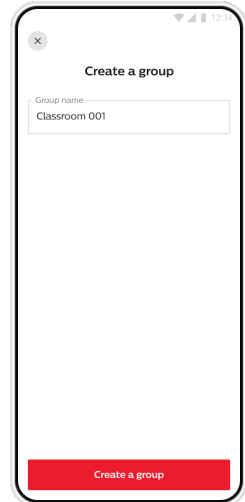

2.6

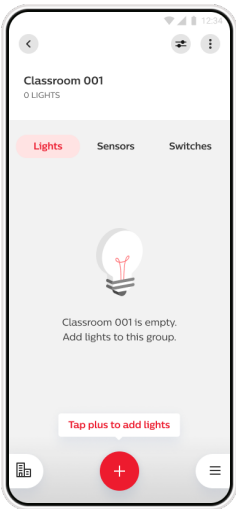

2.7



3 Torchlight Commissioning

3.1

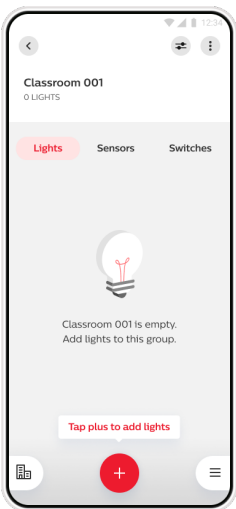

3.2

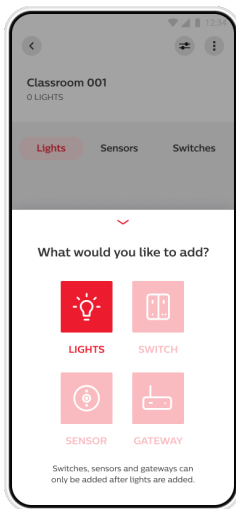

3.3

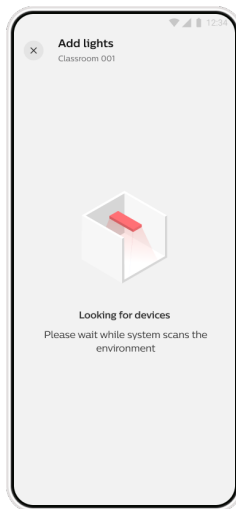

3.4

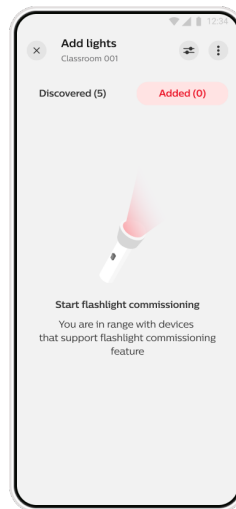

3.5

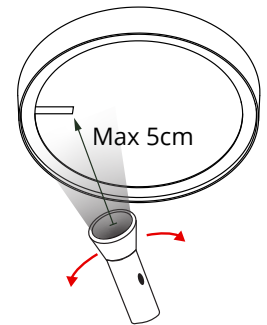

3.6

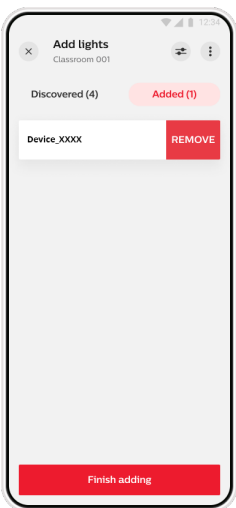

3.7

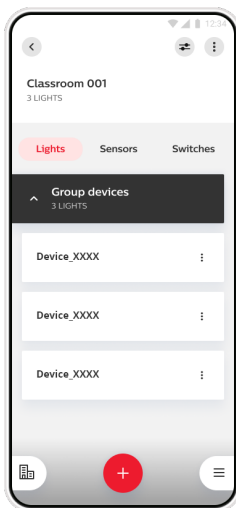

4 List Based Commissioning

4.1

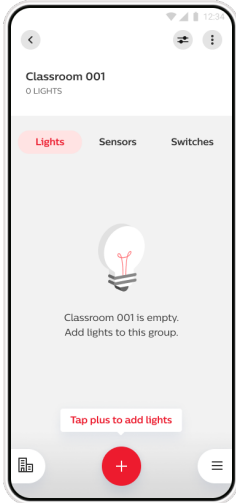

4.2

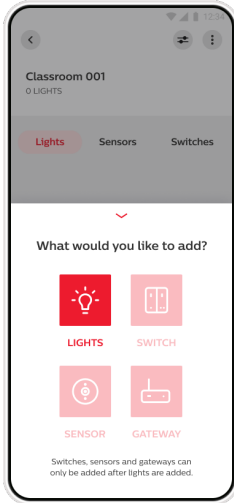

4.3

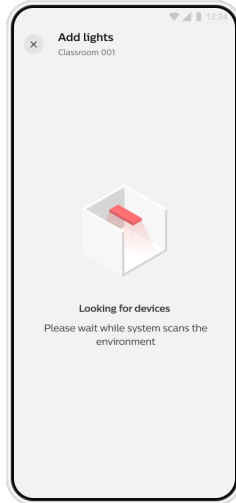

4.4

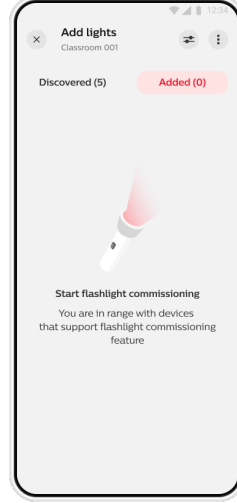

4.5

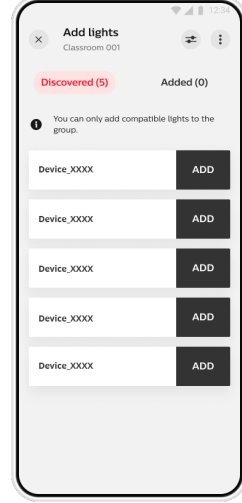

4.6

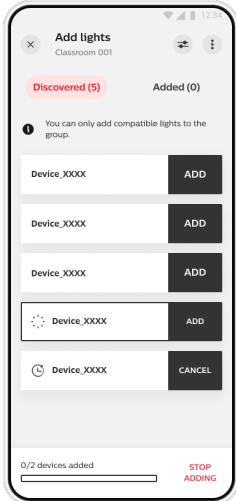

4.7

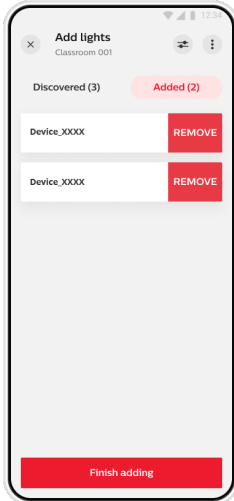

4.8

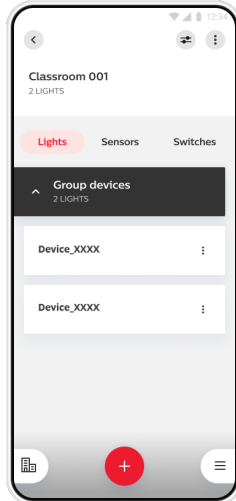

5 Create Zone

5.1

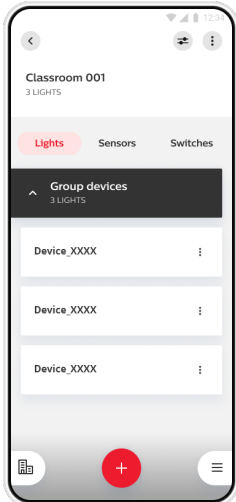

5.2

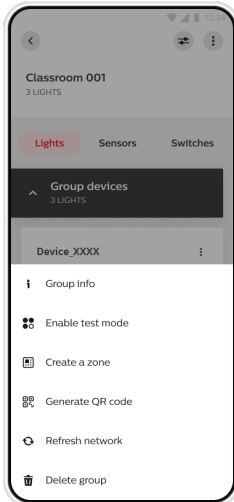

5.3

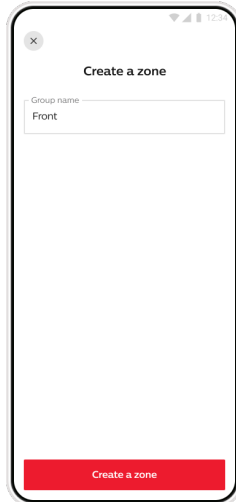

5.4

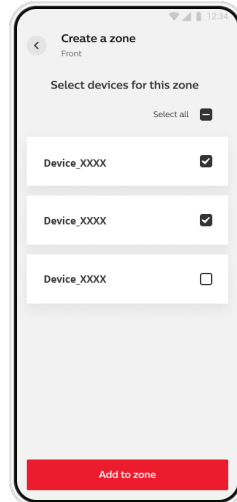

5.5

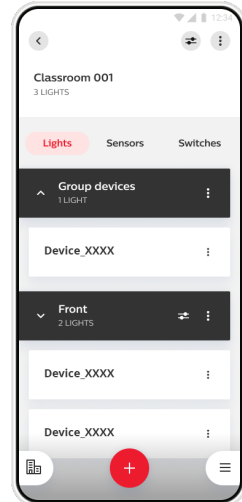

6 Detection

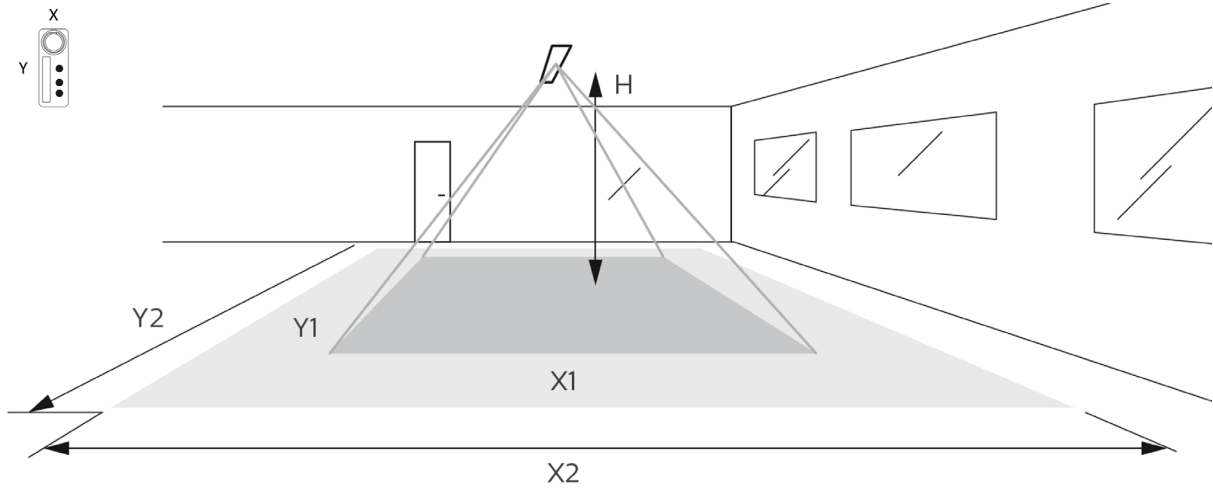

H (m)	Minor Movements		Major Movements	
	X1 (m)	X1 (m)	X2 (m)	Y2 (m)
2,4	1,9	2,9	2,9	4,3
3	2,4	3,6	3,6	5,4