

INSTRUCTION & SERVICE MANUAL

A105NSONTEL Telephone Initiated Alarm Sounder

- -40°C to +66C (-40°F to 151°F)
- Type 4 / 4X / 3R / 13, IP66
- 0.75Kg (1.65lb)
- GOST-R approved. Cert: POCC GB-JB05-H00144
- Nominal output: 105dB(A) @ 1m +/- 3dB [96dB(A) @ 10ft/3m]
- No. of tones: 3
- Volume control: Max. 105dB(A); Min. 96dB(A)
- Effective range: 60m/197ft @ 1KHz
- Supply: Direct power from telephone line (REN 1)
- Ingress protection: IP66

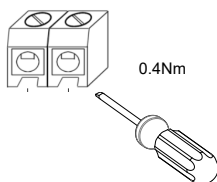
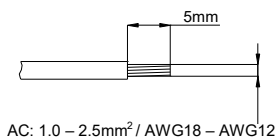
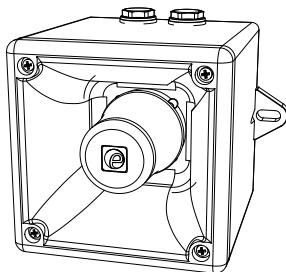

Attention: Installation must be carried out by an electrician in compliance with the latest codes and regulations.

Attention: L'installation doit être effectuée par un électricien conformément aux derniers codes et réglementations.

Achtung: Die Installation muss von einem Elektriker gemäß den neuesten Vorschriften und Bestimmungen durchgeführt werden.

Attenzione: L'installazione deve essere eseguita da un elettricista in conformità con i codici e le normative più recenti.

Atención: La instalación debe ser realizada por un electricista de acuerdo con los últimos códigos y regulaciones.

Atenção: A instalação deve ser realizada por um electricista de acordo com os códigos e regulamentos mais recentes.

Внимание: установка должна выполняться электриком в соответствии с последними нормами и правилами.

Attention: Disconnect from power source before installation or service to prevent electric shock

Attention: Débranchez-le de la source d'alimentation avant l'installation ou l'entretien pour éviter tout choc électrique.

Achtung: Vor Installation oder Wartung von der Stromquelle trennen, um einen Stromschlag zu vermeiden.

Attenzione: scollegare dall'alimentazione prima dell'installazione o dell'assistenza per evitare scosse elettriche.

Atención: desconéctelo de la fuente de alimentación antes de la instalación o el servicio para evitar descargas eléctricas.

Atenção: Desconecte da fonte de alimentação antes da instalação ou serviço para evitar choque elétrico

Внимание: отключите от источника питания перед установкой или обслуживанием, чтобы предотвратить поражение электрическим током.



(See D247-06-001)

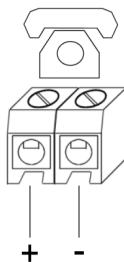

VOLUME CONTROL

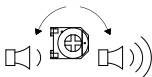

tone TABLE

Tone	Description		
Tone 1	Siren Tone		108dB(A)
Tone 2	Alternating tone		104dB(A)
Tone 3	Sw eeping tone		106dB(A)

dB(A) output figures: +/-3dB(A)

INSTRUCTION & SERVICE MANUAL
A105NSONTEL Telephone Initiated Alarm Sounder

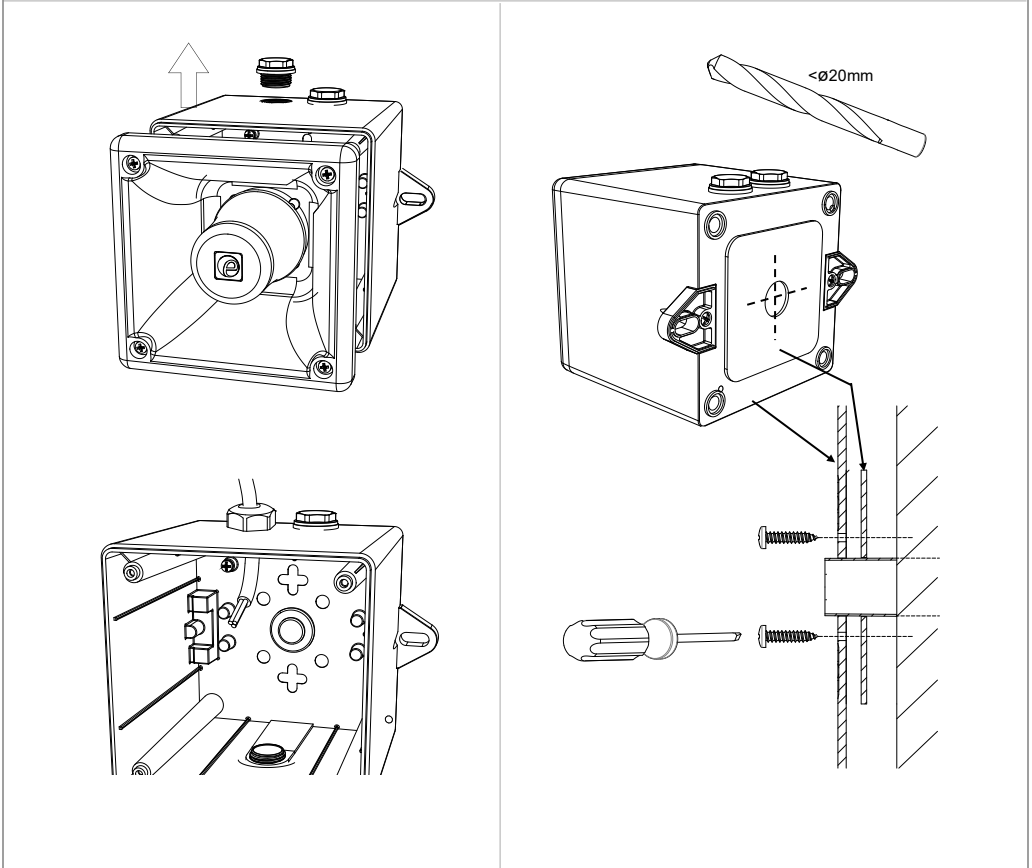
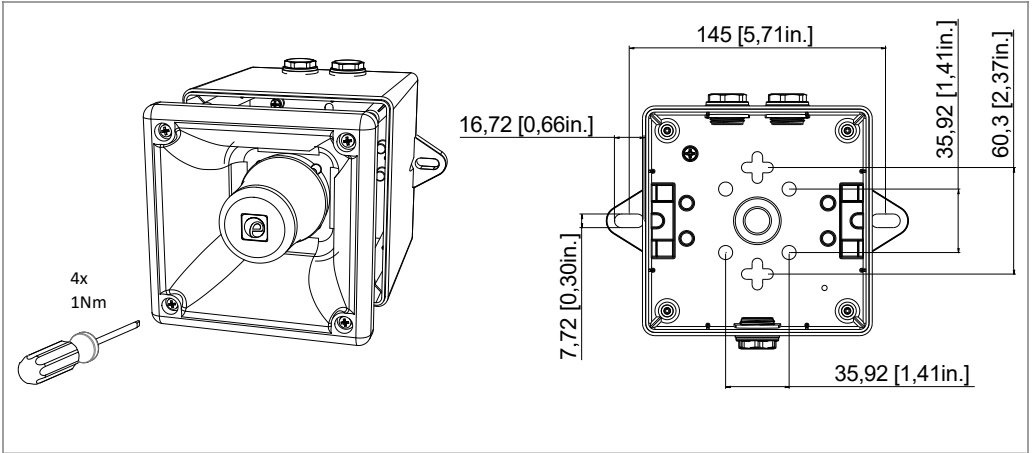

1 2 3 4 5 6 7 8 9 10

ISSUE	MOD No.	REASON - INITIAL - DATE
A		INTRODUCTION JS- 30/06/2021

A100/ A105 SONTEL

AL100/ AL105 SONTELFASH

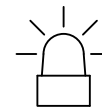
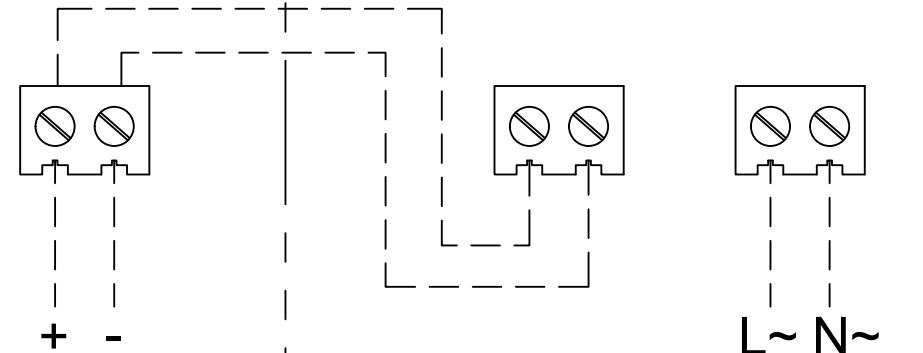
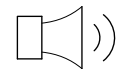
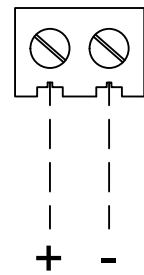
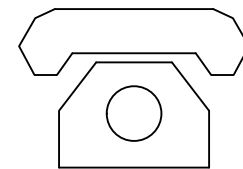
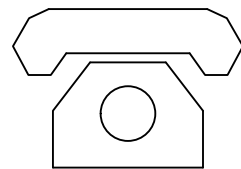

DRAWING TO BS8888:2000
GEOMETRIC TOLERANCES TO ISO1101:1983
LINEAR DIMENSIONAL TOLS
ANGULAR DIMENSIONAL TOLS

DRAWN J. SPILLER DATE 30/06/2021

CHECKED B.ISARD DATE 30/06/2021

APPROVED R.N.POTTS DATE 30/06/2021

STANDARDS
SONTEL / FLASHTEL

SURFACE FINISH WEIGHT (Kg)

MATERIAL

ALTERNATIVE MATERIAL

THIS DRAWING AND ANY INFORMATION OR DESCRIPTIVE MATTER THEREIN IS COMMUNICATED IN CONFIDENCE AND IS THE COPYRIGHT PROPERTY OF EUROPEAN SAFETY SYSTEMS LTD. NEITHER THE WHOLE OR ANY EXTRACT MAY BE DISCLOSED, LOANED, COPIED OR USED FOR MANUFACTURING OR TENDERING PURPOSES WITHOUT THEIR WRITTEN CONSENT.

© EUROPEAN SAFETY SYSTEMS LTD. AS PER LATEST DATE OF ISSUE SHOWN ABOVE



EUROPEAN SAFETY SYSTEMS LTD
IMPRESS HOUSE
MANSELL ROAD
ACTON
LONDON W3 7QH
WWW.E2S.COM

ALL DIMENSIONS IN MM
IF IN DOUBT, ASK -
DO NOT SCALE

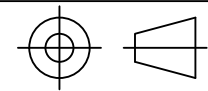

A3

TITLE A100/AL100/A105/AL105 SONTEL / FLASHTEL WIRING SCHEMATIC

SCALE NTS	SHEET 1 OF 1	DRAWING NUMBER D247-06-001
--------------	-----------------	-------------------------------

A
B
C
D
E
F
G

A
B
C
D
E
F
G