

PBV22015 / PBV22015-SON Blitzleuchte - Betriebs- und Montageanleitung

Maße

PBV22015

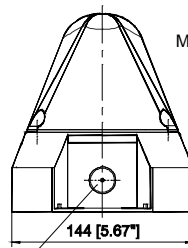
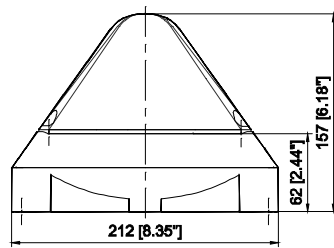

M20-Ausbruch
vorbereitet

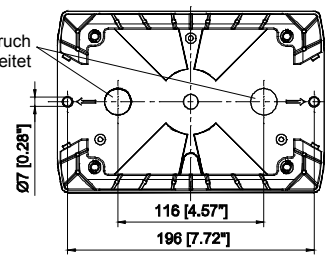

Kartoninhalt:
1x Alarmgerät
1x Membrannippel M20
1x Betriebsanleitung
1x Widerstand (nur -SSM)

M20-Ausbruch vorbereitet (beide Seiten)

PBV22015-SON

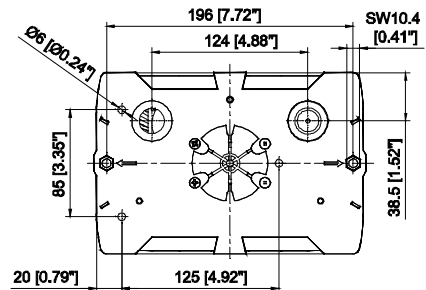
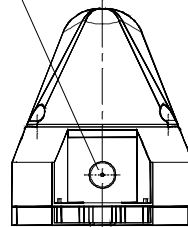
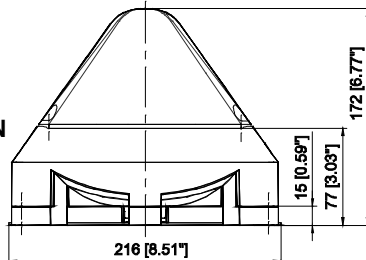

Technische Daten

	PBV22015				PBV22015-SON			
Blitzenergie	15J				15J			
Nennlichtstärke eff.	190 cd (klar)				190 cd (klar)			
Blitzfolgefrequenz	0,1 / 0,5 / 0,75 / 1 Hz							
Nennschallpegel	-				102 dB (A) @1m			
Lautstärkeregelung	-				max. - 20 dB			
Töne	-				8			
Bemessungsspannung	230V AC	115V AC	24V AC (+/-10%)	24V DC (+/- 20%)	230V AC	115V AC	24V AC (+/-10%)	24V DC (+/- 20%)
Nennfrequenz	50/60 Hz				50/60 Hz			
Funktionsbereich	187 – 255V	90 – 135 V	21,6 – 26,4V	19,2 – 28,8V	187 – 255V	90 – 135V	21,6 – 26,4 V	19,2 – 28,8V
max. Stromaufnahme Blitzleuchte (1Hz) [mA]	170	350	970	670	170	350	970	670
Nom. Stromaufnahme Blitzleuchte (1Hz) [mA]	150	300	890	540	150	300	890	540
Stromaufnahme Schallgeber [mA]	-	-	-	-	50 Hz: 10 – 25	60 Hz: 10 – 20	50/60Hz: 40	20
Leistungsaufnahme	34,5 VA	34,5 VA	22 VA	13 W	38 VA	36,5 VA	23 VA	13,5 W
Einschaltdauer	100%							
Anschlussklemmen	0,14 - 2,5mm ² feindrätig / AWG24 - AWG 14 (stranded)							
Schutzart	IP66 (EN60529), Type 4 & 4x							
Schlagfestigkeit	IK 08 (EN50102)							
Schutzklasse	II							
Betriebstemperatur	-40°C...+55°C (UL Certification siehe Seite 6/ see page 6)							
Lagertemperatur	-40°C...+70°C							
Max. rel. Luftfeuchte	90%							
Kabeleinführung	4x M20 vorgeprägt				4x M20 vorgeprägt			
Dichtbereich des Membrannippels	7 – 13 mm - Bei Verwendung von Kabeldurchmessern < 7 mm ist eine Kabelverschraubung mit ausreichender Schutzart vorzusehen							
Gehäusematerial	PC/ABS Blend							
Haubenmaterial	PC							
Einbaulage	beliebig							
Option	- Aktivierungseingang, -SSM (Soft-Start-Modul, nur 24V DC)							
Haubenfarben	klar, weiß, gelb, orange, rot, grün, blau							

Zulassungen

Zulassungen (gilt für gekennzeichnete Betriebsmittel)	
UL, cUL in Vorbereitung	PBV22015 + PBV22015-SON: UCST, UCST7, UEES, UEES7 (weiterführende Informationen siehe Seite 6)

Inbetriebnahme

Sicherheitshinweise:

- Der elektrische Anschluss darf nur von hierfür autorisierten Personen in Übereinstimmung mit den derzeit gültigen Vorschriften durchgeführt werden.
- Warnung vor gefährlicher hoher elektrischer Spannung.
- Vor dem Öffnen ist sicherzustellen, dass das Gerät nicht unter Spannung steht.
- Vor Inbetriebnahme ist die auf dem Typenschild angegebene Versorgungsspannung zu kontrollieren. Eine falsche Betriebsspannung kann zur Schädigung bzw. zur Zerstörung des Betriebsmittels führen.
- Bei der Installation ist darauf zu achten, dass die Anschlussleitung gegen Zug und Verdrehen abgesichert ist. Bitte beachten: Die Geräte sind nicht für einen ortsveränderlichen Einsatz bestimmt.
- WARNUNG: Verdrahtung entfernt von scharfen Kanten, Ecken und internen Komponenten vornehmen.
- Die Funktion des Gerätes ist nur gewährleistet, wenn Ober- und Unterteil korrekt zusammengefügt sind.
- Um eine Beeinträchtigung des Sehvermögens zu verhindern, ist der dauernde, direkte Blick in die aktivierte Leuchte zu vermeiden.
- DC-Spannung: Das Gerät ist mit einem Verpolungsschutz ausgestattet. Keine Funktion bei Verpolung der Anschlüsse!

Öffnen des Gehäuses:

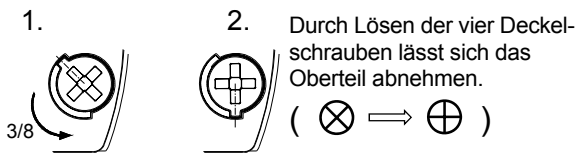

Verschließen des Gehäuses

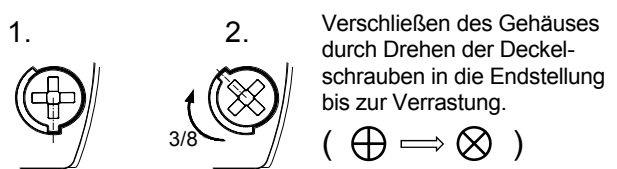

Das Gerät wird in nicht verschlossenem Zustand ausgeliefert. Plombierstopfen für die Gehäuseschrauben sind als Zubehör erhältlich.

Elektrischer Anschluss: (Platine im Unterteil)

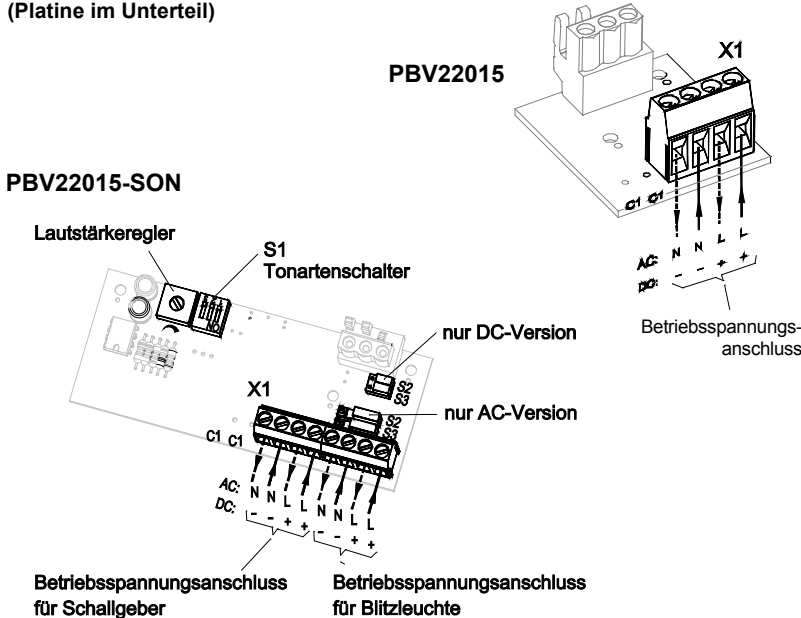

PBV22015-SON

	Anschlussklemmen des Schallgebers führen Betriebsspannung.		**
	Betrieb gemeinsam	X1	
	nur „+“ / „-“ gemeinsam	X1	
	nur „+“ / „-“ gemeinsam	X1	
Betrieb Getrennt	X1		
* Werkseinstellung			

** Bei Kombigeräten (PBV22015-SON) können Blitzleuchte und Schallgeber zusammen oder separat betrieben werden. Dazu sind S2 und S3 wie in der Tabelle dargestellt einzustellen.

Option –SSM (Soft-Start-Modul, nur 24V DC):

- Begrenzung der Einschaltstromspitze auf:

PBV22015(-SON) -SSM:	: max. 4,25 A	: max. 4,25 A
-----------------------------	---------------	---------------

- Durchschalten der Betriebsspannung zum Betriebsmittel erst ab >7V
 - Widerstand zur Leitungsüberwachung angeschlossen

Betriebsspannungsbereich: 19,2 – 28,8V DC

Anschluss eines Widerstandes zur Leitungsüberwachung: (nur DC-Versionen)

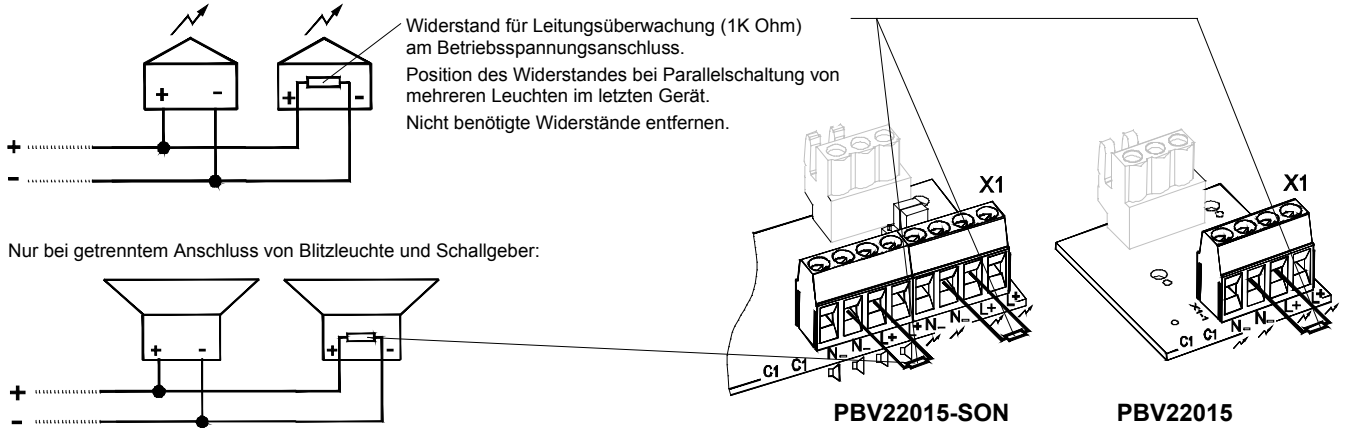

Nur bei getrenntem Anschluss von Blitzleuchte und Schallgeber:

Einstellung der Blitzfrequenz:



* Werkseinstellung

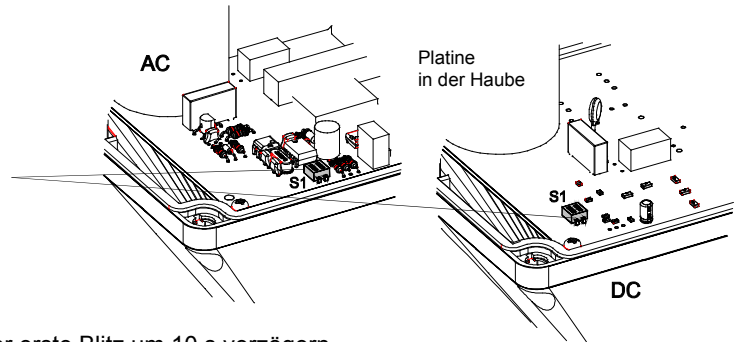

Hinweis: Je nach eingestellter Frequenz kann sich der erste Blitz um 10 s verzögern.

Synchronizität:

Die Leuchten erfüllen die Anforderungen der EN54-23 (Gleichlauf).

Achtung: Um einen Gleichlauf sicherzustellen, müssen die Geräte zwingend mit demselben Potential betrieben werden.

Einstellung der Tonarten (für PY X-LA-15):

2	Sägezahn DIN 33404-3 (Notsignal) PFEER PTAP	1200 Hz 500 Hz		ON	OFF
9	Ansteigender Ton Feueralarm UK BS5839-1	970 Hz 800 Hz		ON	OFF
131	Wechselton UK BS5839-1, Feueralarm Bahn- übergang	1000 Hz 800 Hz		ON	OFF
160	Dauerton (Horn)	110 Hz		ON	OFF
161	Dauerton	3000 Hz		ON	OFF
162	Unterbrochener Ton	3000 Hz		ON	OFF
163	Unterbrochener Ton	3000 Hz		ON	OFF
164	Ansteigender Ton	2850 Hz 2400 Hz		ON	OFF

* Werkseinstellung, Tonartenschalter S1 auf Schallgeber-Platine im Unterteil, siehe Kapitel „elektrischer Anschluss“.

Leuchten mit Aktivierungseingang:

Bei dieser Option kann die Blitzleuchte mittels Steuerspannung aktiviert werden. Die Leistungsaufnahme des Steuereingangs beträgt max. 1W.

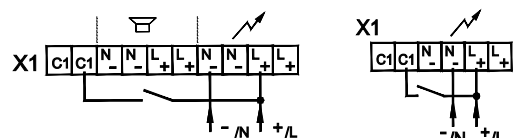

Kabeldurchführungen:

Zur Sicherstellung der angegebenen Schutzart sind an den dafür vorgesehenen Durchbrüchen Kabeldurchführungen mit einer Schutzart von IP 66 zu montieren. Der mitgelieferte Membrannippel kann durch eine Kabelverschraubung oder durch einen M12-Steckverbinder mit einem Flanschmaß von M20 ersetzt werden.

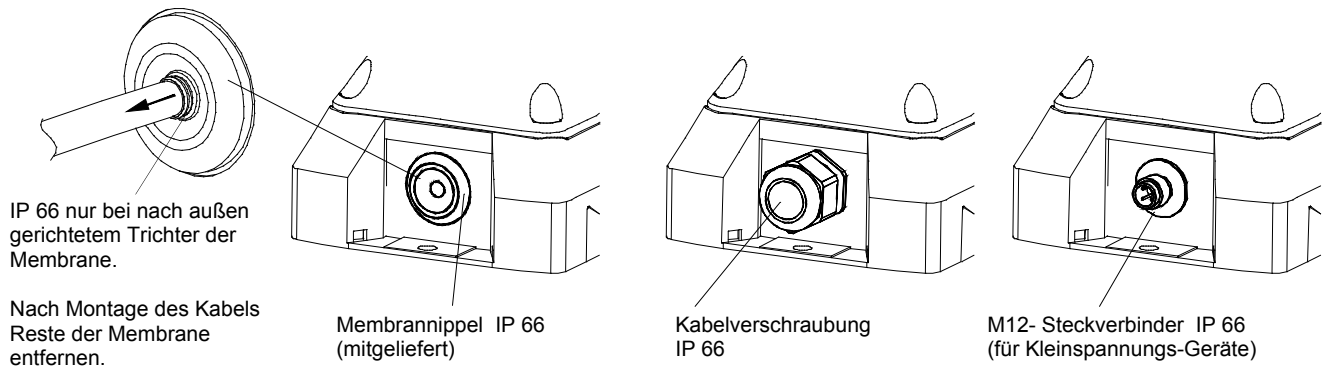

Zubehör

Plombierstopfen, 4er-Pack	Art.-Nr. 28300000002
Flächendichtung PBV22015	Art.-Nr. 28111500002
Flächendichtung PBV22015-SON	Art.-Nr. 28111500001

Wartung, Service, Instandhaltung

Das Gerät erfordert keine besondere Wartung. Die äußere Reinigung sollte mit einer schwachen Seifenlösung ohne Verwendung von Lösungsmittel erfolgen.

Die Blitzleuchte darf nur in unbeschädigtem Zustand innerhalb der spezifizierten Kenndaten betrieben werden. Umbauten, Änderungen, fehlerhafter und unzulässiger Einsatz sowie die Nichtbeachtung der Hinweise dieser Betriebsanleitung schließen eine Gewährleistung aus.

Ein Austausch von Komponenten darf nur mit Originalersatzteilen erfolgen. Reparaturen sind grundsätzlich im Herstellerwerk auszuführen.

Operating and installation instruction for PBV22015/ PBV22015-SON beacon

Dimensions

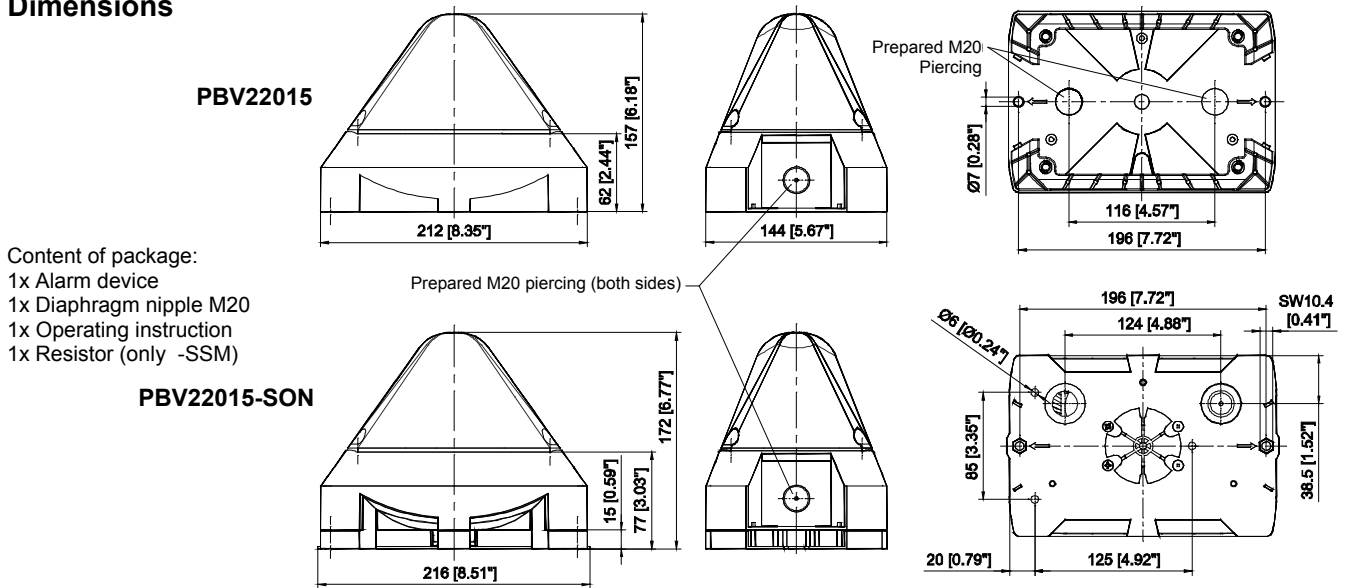

Technical Data

	PBV22015				PBV22015-SON			
Flash energy	15J				15J			
Rated effective luminous intensity	190 cd (clear)				190 cd (clear)			
Flash frequency	0,1 / 0,5 / 0,75 / 1 Hz							
Nom. sound level	-				102 dB (A) @1m			
Volume control	-				max. - 20 dB			
Tones	-				8			
Rated voltage (see special requirements for approved units on page 6)	230V AC	115V AC	24V AC (+/-10%)	24V DC (+/- 20%)	230V AC	115V AC	24V AC (+/-10%)	24V DC (+/- 20%)
Frequency	50/60 Hz				50/60 Hz			
Operating voltage range	187 – 255 V AC	90 – 135 V AC	21.6 – 26.4 V AC	19.2 – 28.8V	187– 255V V AC	90 – 135 V AC	21.6 – 26.4 V AC	19.2 – 28.8V
Current consumption max. Beacon (1Hz) [mA]	170	350	970	670	170	350	970	670
Current consumption nom. Beacon (1Hz) [mA]	150	300	890	540	150	300	890	540
Current consumption Sounder [mA]	-	-	-	-	50 Hz: 10 – 25	60 Hz: 10 – 20	50/60Hz: 40	20
Power consumption	34,5 VA	34,5 VA	22 VA	13 W	38 VA	36,5 VA	23 VA	13,5 W
Duty cycle	100%							
Connection terminal	0,14 - 2,5mm ² / AWG24 - AWG 14 (stranded)							
Protection system	IP66 (EN60529) , Type 4 & 4x							
Resistance against impact	IK 08 (EN50102)							
Protection class	II  Double insulated equipment							
Operating temp.	-40°C...+55°C (UL certification see page 6)							
Storage temperature	-40°C...+70°C							
Max. rel. Humidity	90%							
Cable entry	4x M20 (prepared)				4x M20 (prepared)			
Sealing range of diaphragm nipple	7 – 13 mm - With the use of cable diameters <7 mm, a cable screw joint with sufficient ingress protection must be provided							
Material of housing	PC/ABS Blend							
Material of lens	PC							
Installation position	arbitrary							
Option	- Control input, -SSM (Soft start module, 24V DC only)							
Lens colours	clear, white, yellow, amber, red, green, blue							

Approvals (valid for marked equipment)

UL, cUL in preparation	PBV22015 + PBV22015-SON	
		Visual Signal Appliance - General Signaling Equipment (UEES, UEES7) (PBV22015) Audible and Visual Appliance for General Signaling (Non Fire Alarm) Use (UCST, UCST7 and UEES, UEES7) (PBV22015)
	Rated Voltage	115V AC or 230V AC or 24V DC / 24V AC
	Amb. Temp.	-40°C .. +66°C
	115V AC 230V AC	Suitable for indoor and outdoor use. Warning: Not to be used as a Visual Public Mode Alarm Notification Appliance.(PBV22015) Warning: Not to be used as an Audible and Visual Public Mode Alarm Notification Appliance.(PBV22015-SON) According to CSA-C22.2 No. 205-12 clause 4.3.4 the connection is limited to max. six leads. <u>Installation:</u> The units shall be installed indoors or outdoors in accordance with the manufacturer's installation instructions as well as the National Electrical Code (NFPA 70) in US. In Canada, they shall be installed in accordance with the Canadian Electrical Code, Part 1. The installations shall also be in a manner acceptable with the local authority having jurisdiction.

PYRA Xenon beacons PBV22015(-SON) comply with the limits for a Class A digital device, pursuant to part 15 of the FCC Rules.

Taking into Operation

Safety notes:

- Installation must be carried out by an electrician in compliance with the latest codes and regulations.
- Danger: High voltage may be present.
- Prior to opening, it must be ensured that no voltage is applied to the device.
- Before electrical connection, the supply voltage on the type plate is to be checked. The wrong operating voltage can lead to damages or to the destruction of the equipment.
- During installation it must be ensured that the connection cables are secured against tension and distortion.
Please observe: The devices are not designed for portable use.
- CAUTION: When making installation, route field wiring away from sharp projections, corners and internal components.
- The function of the unit is only guaranteed if the upper and lower section is joined correctly.
- In order to prevent detriment to sight, continuously looking directly in the activated light is to be avoided.
- DC voltage: The device is provided with a reverse polarity protection. No function when polarity is reversed!

Opening the housing

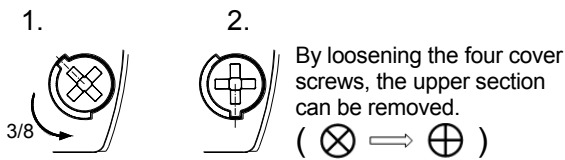

Closing the housing

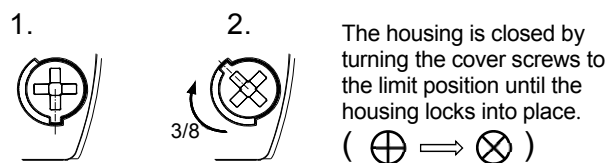

The unit is not closed when delivered. Sealing plugs for the housing screws are available as accessories.

Electrical connection: (PCB in base part)

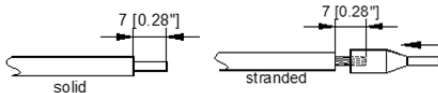

Connecting cables

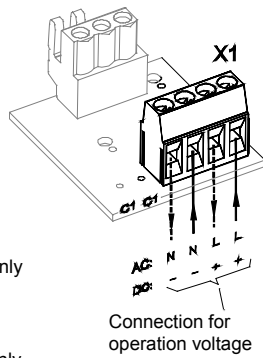
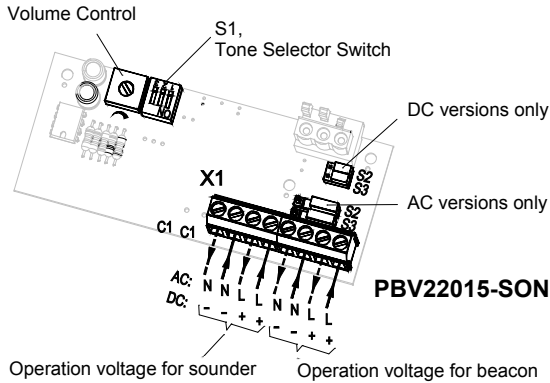

PBV22015

PBV22015-SON

Connection terminals of the sounder carry rated voltage.		**
		S2 * S3
		S2 S3
		S2 S3
	S2 S3	
	S2 S3	
	S2 S3	
	S2 S3	

* Factory setting

** : Combined beacon-sounders (PY X-LA-15) can be operated commonly or separately. Adjust S2 and S3 as shown in the table.

Option –SSM (Soft-Start-Module) (24V DC only):

- Limiting of the switch-on current peak to:

PBV22015(-SON) -SSM:	: max. 4.25 A	: max. 4.25 A
-----------------------------	---------------	---------------

- Connection of the operating voltage to the equipment starts at >7V
- Resistance for the line monitoring mounted.

Operating voltage range: 19.2 – 28.8V DC

Connection of a resistor for line monitoring: (dc versions only)

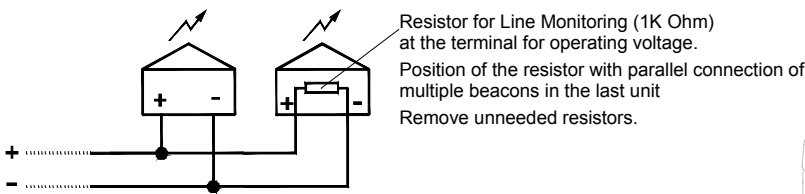

Only in case of separate operation of beacon and sounder:

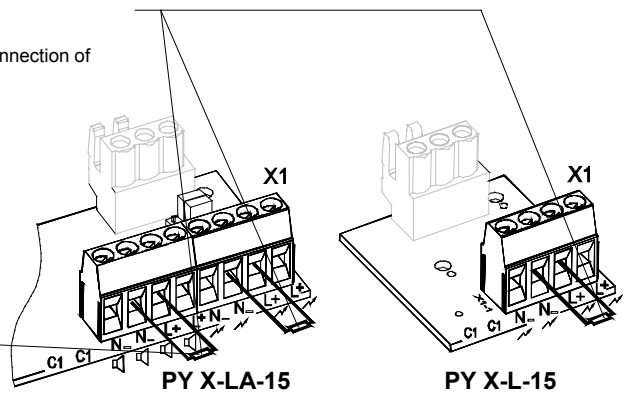
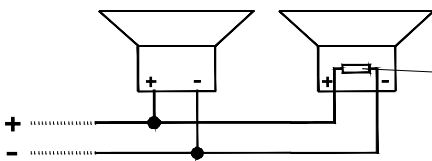

Flash Frequency adjustment:

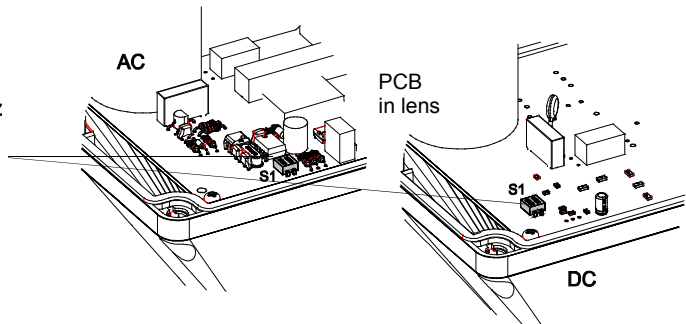
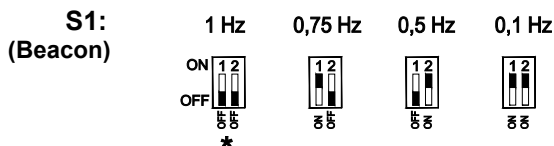

Note: Depending on the adjusted flash frequency the appearance of the first flash after switching on may take up to 10 s.

Synchronization:

The beacons satisfy the requirements of the standard EN54-23 (Synchronization).

Caution: In order to ensure synchronization, the devices must be operated with the same potential.

Tone table (for PBV22015-SON):

2	Sawtooth DIN 33404-3 (Emergency signal) PFEER PTAP	1200 Hz 1 s 500 Hz	ON 1 2 3 OFF 1 2 3 1 2 3 1 2 3	161	Continuous tone	3000 Hz	ON 1 2 3 OFF 1 2 3 1 2 3 1 2 3
9	Slow whoop Fire alarm UK BS5839-1	970 Hz 1 s 800 Hz	ON 1 2 3 OFF 1 2 3 1 2 3 1 2 3	162	Interrupted tone	3000 Hz 0.5 s 0.5 s	ON 1 2 3 OFF 1 2 3 1 2 3 1 2 3
131	Alternating tone, UK BS5839-1, Fire alarm, railway crossing	1000 Hz 0.25 s 800 Hz 0.25 s	ON 1 2 3 OFF 1 2 3 1 2 3 1 2 3	163	Interrupted tone	3000 Hz 25 ms 25 ms	ON 1 2 3 OFF 1 2 3 1 2 3 1 2 3
160	Continuous tone (Horn)	110 Hz	ON 1 2 3 OFF 1 2 3 1 2 3 1 2 3	164	Slow whoop	2850 Hz 143 ms 2400 Hz	ON 1 2 3 OFF 1 2 3 1 2 3 1 2 3

* Factory setting, Tone selector switch S1 on sounder pcb inside base part, see chapter „electrical connection“.

Devices with control input:

This option allows the beacon to be activated via control voltage.

The maximum current consumption of the control input is max. 1W.

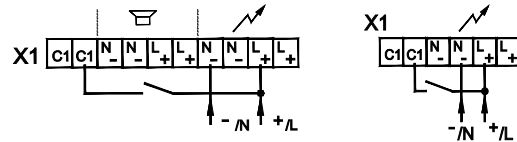

Cable gland entries:

To guarantee the specified protection type, cable grommets with a protection type of IP 66 are to be installed at the openings provided for this purpose. The supplied diaphragm nipple can be replaced with a cable gland or with an M12 plug connection with a flange measurement of M20. Not to be connected to rigid metal conduits.

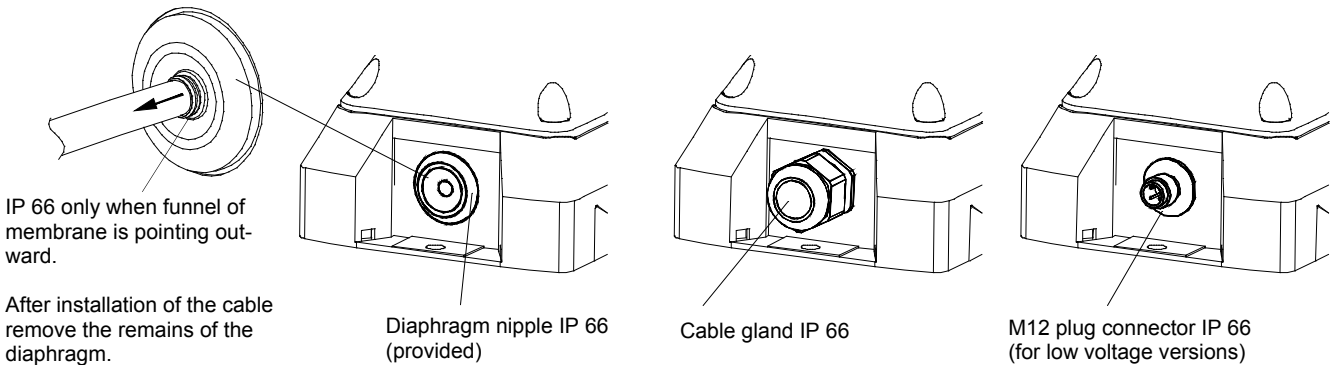

Accessory

Tamper-proof sealing, pack of 4	Part-no. 28300000002
Surface gasket PBV22015	Part-no. 28111500002
Surface gasket PBV22015-SON	Part-no. 28111500001

Maintenance, Service and Ordering Spare Parts

The device does not require any special maintenance. External cleaning should be done with a mild soap solution without the use of solvents. The device may only be operated in the undamaged state within the specified rating.

Conversions, alterations, improper and inadmissible use as well as the non-observance of the notes in these operating instructions shall render the warranty null and void. Components may be replaced only by original spare parts. As a matter of principle, repairs are to be carried out in the manufacturing works.

Utilisation et de montage pour lampe flash PBV22015/ PBV22015-SON

Dimensions

PBV22015

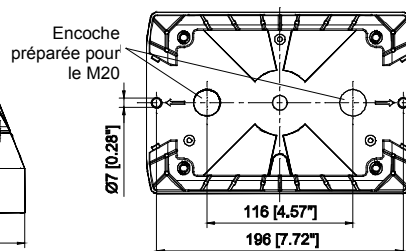
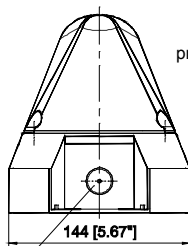
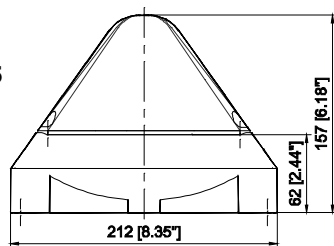

Contenu de l'emballage :
 1 alarme
 1 raccord fileté à membrane M20
 1 instruction d'utilisation
 1 Résistor (seulement -SSM)

Encoche préparée pour le M20 (2x)

PBV22015-SON

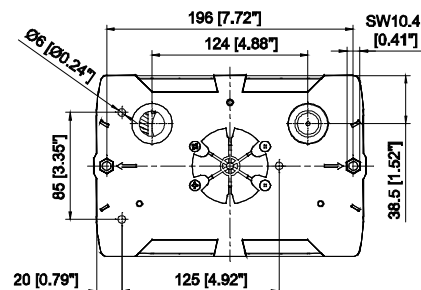
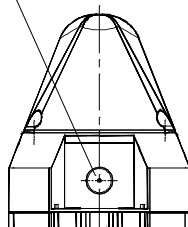
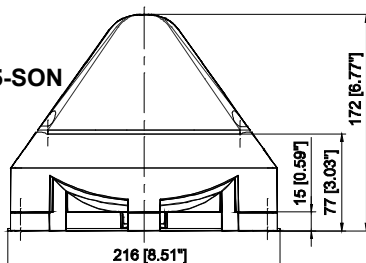

Caractéristiques techniques

	PBV22015				PBV22015-SON			
Energie lumineuse	15J				15J			
Nom. intensité lumineuse effective	190 cd (clair)				190 cd (clair)			
Fréquence du clignotement	0,1 / 0,5 / 0,75 / 1 Hz							
Niveau sonore nom.	-				102 dB (A) @1m			
Réglage du volume	-				max. - 20 dB			
Sons	-				8			
Tension de service	230V CA	115V CA	24V CA (+/-10%)	24V CC (+/- 20%)	230V CA	115V CA	24V CA (+/-10%)	24V CC (+/- 20%)
Fréquence nom.	50/60 Hz				50/60 Hz			
Plage de la tension de service	187 – 255V	90 – 135V	21,6 – 26,4 V CA	19,2 – 28,8V	187 – 255V	90 – 135V	21,6 – 26,4 V CA	19,2 – 28,8V
Courant absorbé max. par le flash (1Hz) [mA]	170	350	970	670	170	350	970	670
Courant absorbé nominal par le flash (1Hz) [mA]	150	300	890	540	150	300	890	540
Courant absorbé nominal par la sirène [mA]	-	-	-	-	50 Hz: 10 – 25	60 Hz: 10 – 20	50/60Hz: 40	20
Puissance	34,5 VA	34,5 VA	22 VA	13 W	38 VA	36,5 VA	23 VA	13,5 W
Facteur de marche	100%							
Bornes de connexion	0,14 - 2,5 mm ² en fils de faible diamètre/ AWG24 - AWG 14 (stranded)							
Type de protection	IP66 (EN60529), Type 4 & 4x							
Résistance aux chocs	IK 08 (EN50102)							
Classe de protection	II							
Température de service	-40°C...+55°C (voir page 6 pour UL certification)							
Température de stockage	-40°C...+70°C							
Humidité rel. max.	90%							
Entrée de câbles	4x M20 avec empreinte préalable				4x M20 avec empreinte préalable			
Zone d'intensité du profilé de protection	7 – 13 mm - En cas d'utilisation de câbles de diamètre < 7 mm, un raccord de câble équipé d'un type de protection suffisant sera à prévoir							
Matériau du boîtier	PC/ABS Blend							
Matériau du capot	PC							
Position de montage	quelconque							
Option	-Entrée de commande, -SSM (Démarrage en douceur, uniquement 24 V CC)							
Couleurs du capot	Clair, blanc, jaune, orange, rouge, vert, bleu							

Admissions

Admissions (valable pour les appareils signalés)	
UL, cUL En préparation	PBV22015 + PBV22015-SON: UCST, UCST7, UEES, UEES7 (plus d'informations voir page 6)

Mise en service

Consignes de sécurité :

- Le branchement électrique doit être effectué uniquement par des personnes autorisées conformément aux réglementations en vigueur.
- Attention à la tension électrique élevée. Danger !
- Avant d'ouvrir, il convient de s'assurer que l'appareil est hors tension.
- La tension d'alimentation indiquée sur la plaque signalétique doit être vérifiée avant la mise en service. Une tension de service incorrecte peut entraîner un endommagement ou la destruction de l'appareil.
- Il convient de veiller, lors de l'installation, que les cordons d'alimentation ne sont pas soumis à des contraintes de traction ou de torsion. Attention : les appareils ne sont pas destinés à une utilisation mobile.
- AVERTISSEMENT : Lors de l'installation, maintenir les câblages éloignés des bords coupants, coins et composants internes.
- Le fonctionnement de l'appareil n'est garanti que si les parties supérieure et inférieure sont assemblées correctement.
- Pour éviter un risque d'endommagement de l'acuité visuelle, il convient d'éviter le contact visuel direct et permanent avec la lampe.
- Tension continue: La lampe est équipée avec une protection contre l'inversion de polarité. Pas de fonction en cas de l'inversion de la polarité!

Ouverture du boîtier

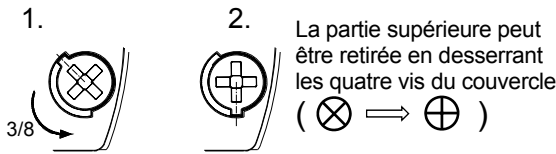

Fermeture du boîtier

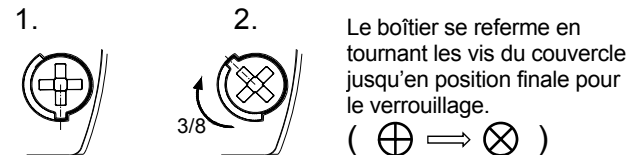

L'appareil est livré en état non verrouillé.
Des bouchons de plombier sont disponibles en accessoires pour les vis du boîtier.

Raccordement à la tension de service: (Platine de raccordement dans la partie inférieure)

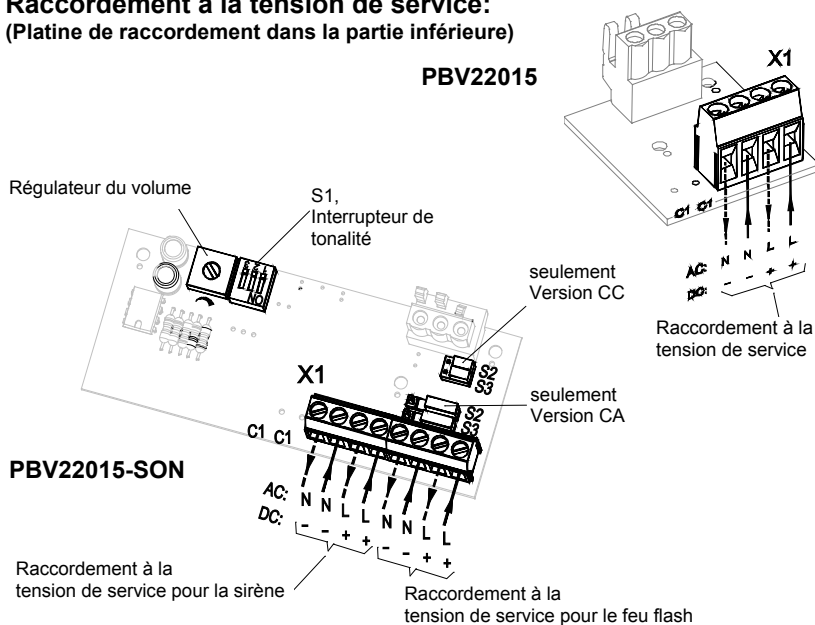

PBV22015-SON:



Les borniers de câblage du sondeur guident la tension de service.		**	
Fonction: ensemble	X1		S2 * S3 *
seulement "+", "+", "N"	X1		S2 S3
seulement "N", "N", "N"	X1		S2 S3
Fonction: séparé	X1		S2 S3

* Réglage d'usine

** Fonctionnement des appareils de combinaison (PBV22015-SON) ensemble ou séparément.
Voir table pour ajustage de S2 et S3.

Option SSM (Module Soft-Start) (uniquement 24 V CC) :

- Limitation de la pointe du courant à l'enclenchement à :

PBV22015(-SON) -SSM:	 : max. 4,25 A	 : max. 4,25 A
-----------------------------	---	---

- Transfert de la tension de service sur l'équipement à partir de > 7V
 - Résistance à la direction des circuits intégrée

Plage de la tension de service : 19,2 – 28,8V CC

Résistance pour la surveillance de ligne : (uniquement 24 V CC)

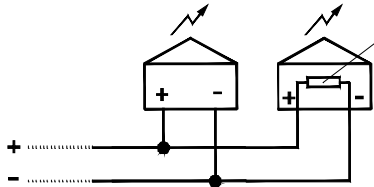

Résistance pour surveillance de ligne (1KOhm) au niveau du raccordement à la tension de service.
 Position de la résistance en branchement en parallèle de plusieurs feux flash sur le dernier appareil.
 Ôter les résistances qui ne sont pas nécessaires.

Seulement pour raccordement séparé du feu flash et de la sirène :

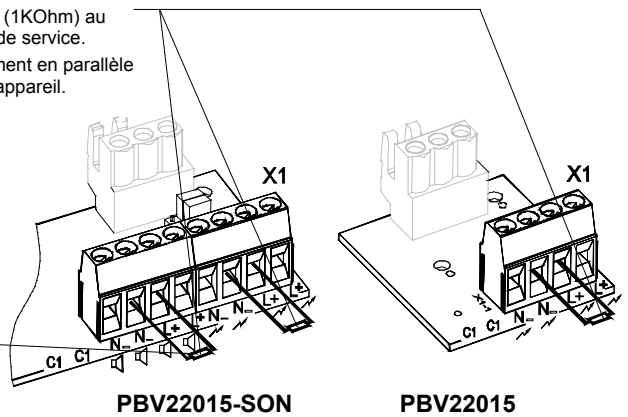
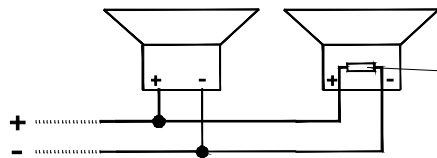

Réglage de la fréquence du flash :



* Réglage d'usine

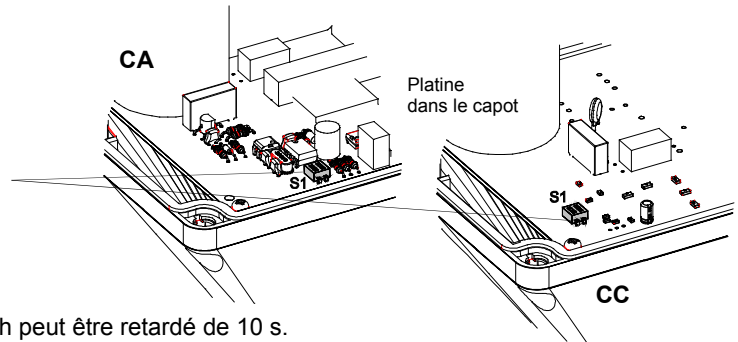









Remarque : Selon la fréquence réglée, le premier flash peut être retardé de 10 s.

Synchronicité :

Les appareils répondent aux exigences de la norme EN54-23 (synchronisme).

Attention : Pour assurer le synchronisme, les appareils doivent impérativement être utilisés avec le même potentiel.

Réglage des types de sons (pour PY X-LA-15) :

2	Sirène lente DIN 33404-3 (Signale d'alarme) PFEER PTAP	1200 Hz 500 Hz		ON 1 2 3 OFF 4 5 6	161	Son continu	3000 Hz		ON 1 2 3 OFF 4 5 6
9	Sirène montante Son évacuation urgence UK BS5839-1	970 Hz 800 Hz		ON 1 2 3 OFF 4 5 6	162	Son intermittent	3000 Hz		ON 1 2 3 OFF 4 5 6
131	Modulé bi-ton UK BS5839-1, Alarme incendie passage à niveau	1000 Hz 800 Hz		ON 1 2 3 OFF 4 5 6	163	Son intermittent	3000 Hz		ON 1 2 3 OFF 4 5 6
160	Son continu (Horn)	110 Hz		ON 1 2 3 OFF 4 5 6	164	Sirène montante	2850 Hz 2400 Hz		ON 1 2 3 OFF 4 5 6

* Réglage d'usine, commutateur des types de sons S1 sur la platine de la sirène dans la partie inférieure, voir le chapitre « Raccordement à la tension de service ».

Lampes flashes avec entrée d'activation :

Avec cette option, la lampe du flash peut être activée à l'aide de la tension de commande. L'entrée de commande consomme au maxi. 1 W.

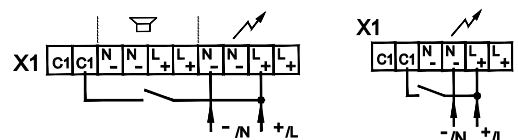

Passages de câbles :

Afin de garantir le type de protection indiqué, des passages de câbles d'une protection IP 66 doivent être montés au niveau des perçages prévus à cet effet. Le raccord fileté à membrane fourni peut être remplacé par un passe-câble à vis ou par un connecteur M12 avec une bride de dimension M20.

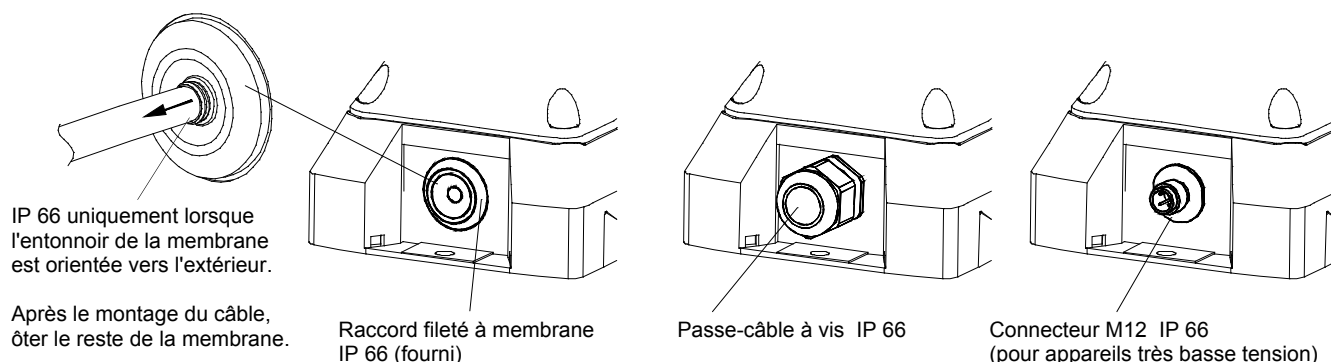

Accessoires

Bouchon de plombier, pack de 4	art. n° 28300000002
Joint de surface PY X-L-15	art. n° 28111500002
Joint de surface PY X-LA-15	art. n° 28111500001

Maintenance, SAV, entretien

L'appareil ne requiert aucune maintenance particulière. Le nettoyage extérieur doit être effectué avec une solution légèrement savonneuse, sans solvants.

L'appareil doit être exploité uniquement en bon état de marche et dans le respect des caractéristiques indiquées. Toute transformation, modification, utilisation incorrecte ou inadmissible ainsi que le non-respect des instructions de service entraînent l'exclusion de la garantie.

Tous les composants doivent être remplacés uniquement par des pièces originales. Les réparations doivent en principe être effectuées dans les ateliers du fabricant.

PBV22015/ PBV22015-SON Инструкция по монтажу и эксплуатации

Размеры

PY X-L-15

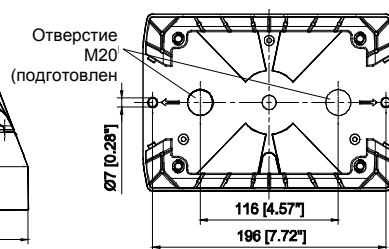
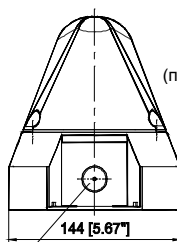
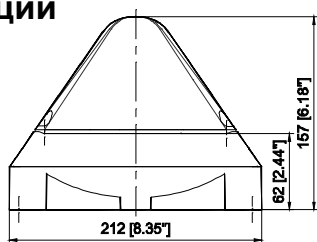

Содержимое упаковки:
 1 устройство сигнализации
 1 мембранный ниппель M20
 1 руководство по эксплуатации
 1 резистор (только -SSM)

Отверстие M20 (подготовлено)(2x)

PY X-LA-15

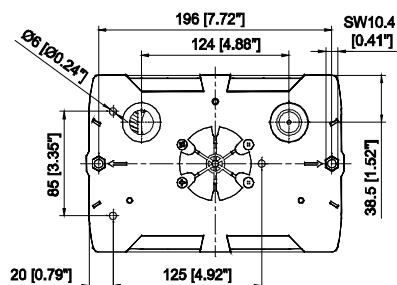
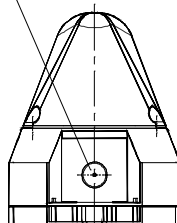
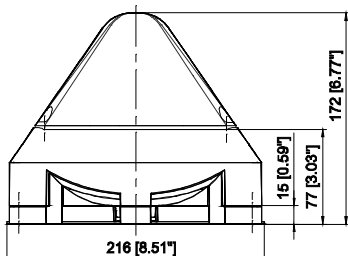

Технические данные

	PBV22015				PBV22015-SON			
Энергия вспышки	15 Дж				15 Дж			
Сила света	190 cd (прозрачная)				190 cd (прозрачная)			
Частота вспышки	0,1 / 0,5 / 0,75 / 1 Гц							
Ном. уровень звука	-				102 дБ (А) @ 1 м			
Регулировка звука	-				макс. - 20 дБ			
Тон	8							
Рабочее напряжение	230 В AC	115 В AC	24 В AC (+/-10%)	24 В DC (+/- 20%)	230 В AC	115 В AC	24 В AC (+/-10%)	24 В DC (+/- 20%)
Номинальная частота	50/60 Гц				50/60 Гц			
Диапазон рабочего напряжения	187 – 255 В	90 – 135 В	21,6 – 26,4 В AC	19,2 – 28,8 В	187 – 255 В	90 – 135 В	21,6 – 26,4 В AC	19,2 – 28,8 В
Максимальный ток, потребляемый проблесковой лампой (1Гц) [mA]	170	350	970	670	170	350	970	670
Номинальный ток, потребляемый проблесковой лампой (1Гц) [mA]	150	300	890	540	150	300	890	540
Номинальный ток, потребляемый излучателем звука [mA]	-	-	-	-	50 Гц: 10 – 25	60 Гц: 10 – 20	50/60 Гц: 40	20
Мощность	34,5 VA	34,5 VA	22 VA	13 W	38 VA	36,5 VA	23 VA	13,5 W
Рабочий цикл	100%							
Соединения	0,14 - 2,5 мм ² , с тонким проводом / AWG24 - AWG 14 (многожильное)							
Тип защиты	IP66 (EN60529), Type 4 & 4x							
Ударная прочность	IK 08 (EN50102)							
Класс защиты	II							
Рабочая температура	-40°C...+55°C (UL сертификат: см. Стр. 6)							
Температура хранения	-40°C...+70°C							
Макс. отн. влажность воздуха	90%							
Кабельный ввод	M20, 4 шт, предварительно подготовлены				M20, 4 шт, предварительно подготовлены			
Допустимый диаметр кабеля	7 – 13 мм; при использовании кабеля диаметром менее 7 мм должна применяться резьбовая втулка с соответствующим классом защиты							
Материал корпуса	Поликарбонат/акрилонитрил-бутадиен-стирол							
Материал линзы	Поликарбонат							
Монтажное положение	Произвольное							
Опции	Вход управления, -SSM (только 24 В пост. Тока)							
Цвет линзы	прозрачная, белый, жёлтый, оранжевый, красный, зелёный, синий							

Допуски

Допуски (только для оборудования с маркировкой)	
UL, cUL в процессе подготовки	PBV22015 + PBV22015-SON: UCST, UCST7, UEES, UEES7 (Дополнительную информацию см. на стр. 6)

Ввод в эксплуатацию

Указания по технике безопасности:

- Подключение электрооборудования разрешается выполнять только уполномоченным сотрудникам в соответствии с предписаниями действующего законодательства.
- Осторожно: высокое напряжение.
- Во время монтажных работ питание должно быть отключено от устройства.
- Перед вводом в эксплуатацию следует проверить соответствие напряжения данным, указанным на заводской табличке. При подключении неверного напряжения оборудование может быть повреждено или выведено из строя.
- Во время монтажа необходимо предусмотреть меры, чтобы проводка не могла быть вытянута или перекручена. Следует принять во внимание, что данные устройства не являются переносными.
- ВНИМАНИЕ! При монтаже кабель не должен касаться острых краёв, углов и внутренних компонентов.
- Корректная работа устройства гарантируется только в том случае, если верхняя и нижняя части смонтированы правильно.
- Чтобы исключить отрицательное влияние на зрение, не рекомендуется долго смотреть на включенную проблесковую лампу.
- Постоянный ток. Устройство оснащено защитой от неправильного подключения полюсов. При неправильной полярности устройство не работает!

Открытие корпуса:

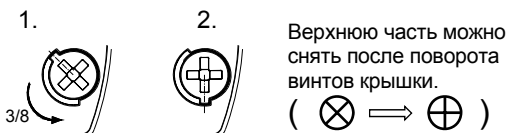

Закрывание корпуса

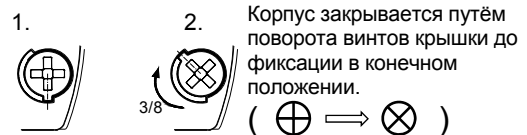

Устройство поставляется в открытом состоянии.
В качестве аксессуаров предлагаются пломбировочные пробки.

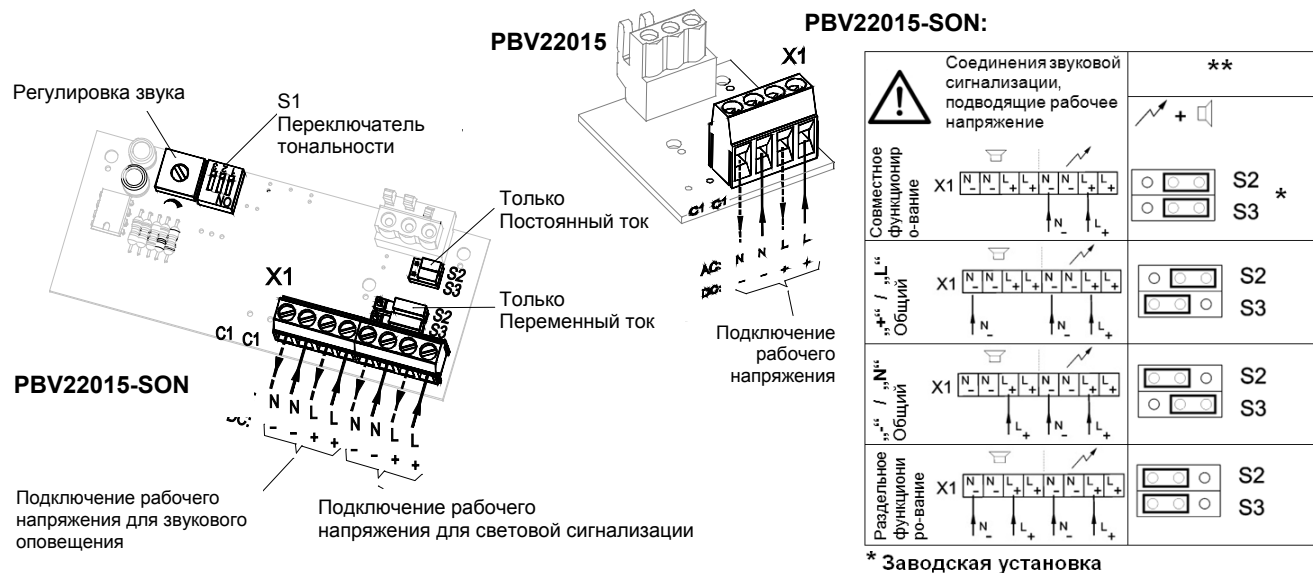

Электрическое подключение:



** В комбинированных устройствах (PBV22015-SON) проблесковые огни и звуковая сигнализация могут активироваться раздельно. Для этого требуется выбрать положение переключателей S2 и S3, как показано в таблице.

Опция SSM (Модуль плавного пуска) (только 24 В пост. Тока):

- Максимальный пусковой ток:

PBV22015(-SON) -SSM:	 : макс. 4,25 А	 : макс. 4,25 А
-----------------------------	--	--

- К устройству подводится напряжение питания, превышающее 7 В
 - Резистор контроля кабеля

Диапазон рабочего напряжения: 19,2 – 28,8 В пост.тока

Резистор контроля цепи (только версия, работающая от постоянного тока) :

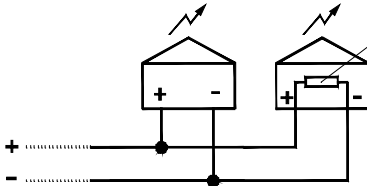

Элемент сопротивления для контроля цепи (1 кОм) на соединении рабочего напряжения. Позиция элемента сопротивления при параллельном подключении нескольких огней к последнему устройству. Лишнее сопротивление удалить.

Только раздельное подключение звукового и светового оповещения:

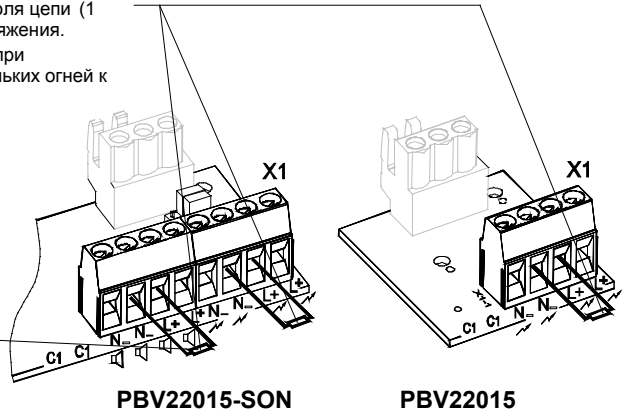
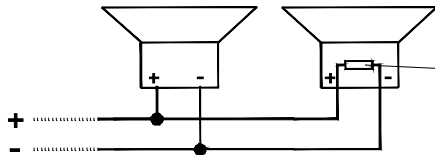

Установка частоты вспышек:

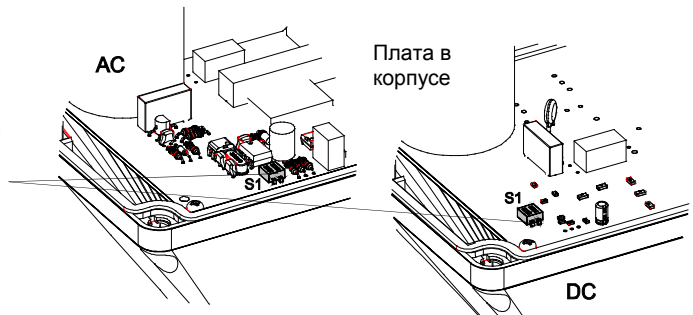
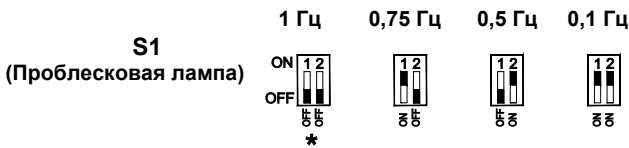

* Заводская установка

Примечание: в зависимости от выбранной частоты, задержка первого сигнала может составлять 10 секунд.

Синхронность:

Огни отвечают требованиям стандарта EN54-23 (синхронность).

Внимание: Для обеспечения синхронности функционирования, устройства должны эксплуатироваться с одинаковым потенциалом.

Выбор тональности (PY X-LA-15) :

2	Звук пилы DIN 33404-3 (аварийный сигнал) PFEER PTAP	1200 Hz 500 Hz		ON 1 2 3 OFF 8 5 6	161	Сигнал с постоянной тональностью	3000 Hz		ON 1 2 3 OFF 8 5 6
9	Пожарный сигнал с повышением тональности UK BS5839-1	970 Hz 800 Hz		ON 1 2 3 OFF 8 5 6	162	Сигнал с прерыванием	3000 Hz		ON 1 2 3 OFF 8 5 6
131	Сигнал с меняющейся тональностью UK BS5839-1, пожарный сигнал, ж/д переезд	1000 Hz 800 Hz		ON 1 2 3 OFF 8 5 6	163	Сигнал с прерыванием	3000 Hz		ON 1 2 3 OFF 8 5 6
160	Сигнал с постоянной тональностью (рупор)	110 Hz		ON 1 2 3 OFF 8 5 6	164	Сигнал с повышением тональности	2850 Hz 2400 Hz		ON 1 2 3 OFF 8 5 6

* Заводская установка, переключатель тональности S1 на плате, в нижней части, см. раздел «Подключение электропитания».

Огни с входом управления:

В этом случае сигнальные огни активируются управляющим напряжением. Потребление входа управления – макс. 1 Вт.

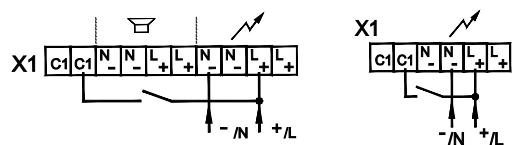

Кабельный ввод:

Для сохранения имеющегося класса защиты в предусмотренные отверстия должны быть установлены кабельные вводы класса IP 66. Поставляемый мембранный nipple можно заменить резьбовой втулкой или штекерным соединением M12 с фланцем M20.

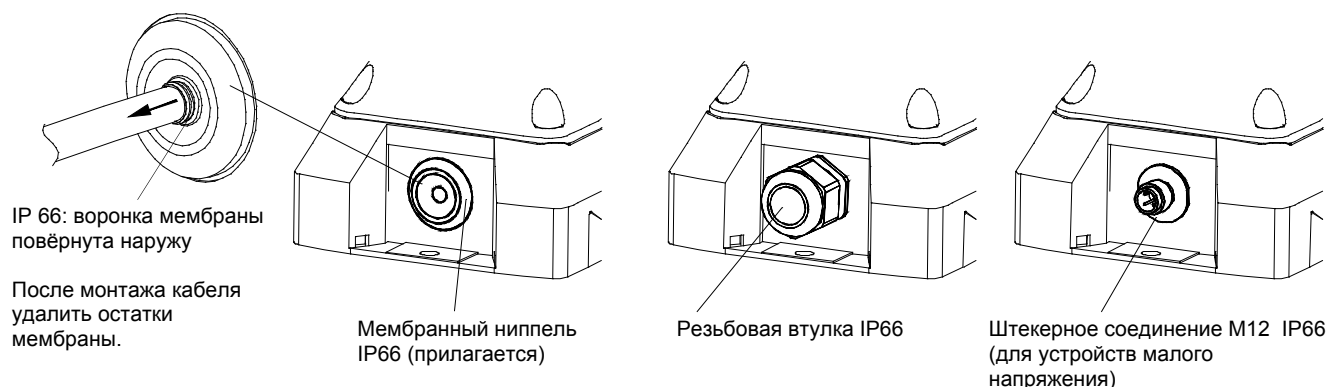

Аксессуары

Пломбировочные пробки (Комплект из 4 шт.)	арт. 28300000002
Контактное уплотнение PBV22015	арт. 28111500002
Контактное уплотнение PBV22015-SON	арт. 28111500001

Техническое обслуживание и поддержание в исправном состоянии

Для данного устройства специальное техническое обслуживание не требуется. Очистка наружных поверхностей осуществляется с помощью слабого мыльного раствора без использования растворителей.

Разрешается использовать устройство только в неповрежденном состоянии, согласно техническим характеристикам. При изменении конструкции, модификации

оборудования, его неправильном использовании и использовании не по назначению,

а также при несоблюдении указаний данного руководства гарантия теряет свою силу.

Разрешается использовать только оригинальные запасные части.

Ремонт производится только на предприятии-изготовителе.

Manuale d'uso e installazione – Luce flash – PBV22015/ PBV22015-SON

Dimensioni

PBV22015

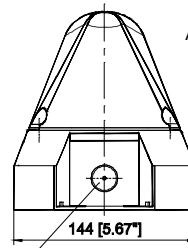
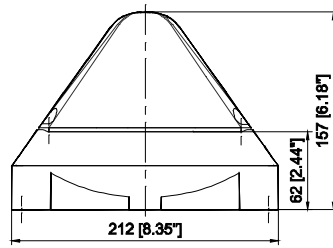

Apertura M20 predisposta

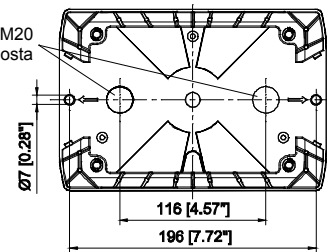

Contenuto della confezione:
1x dispositivo di allarme
1x nipplo a membrana M20
1x resistenza (solo per la versione SSM – modulo soft start)

PBV22015-SON

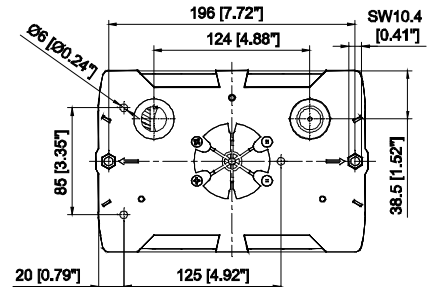
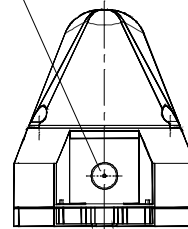
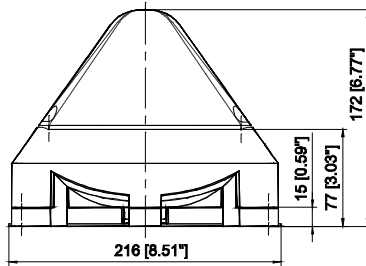

Specifiche tecniche

	PBV22015				PBV22015-SON			
Energia flash	15J 15J							
Intensità luminosa nominale effettiva	190 cd (trasparente)				190 cd (trasparente)			
Frequenza di sequenza flash	0,1 / 0,5 / 0,75 / 1 Hz							
Intensità sonora nominale	-				102 dB (A) @1m			
Regolazione volume	-				max. - 20 dB			
Suoni	-				8			
Tensione nominale	230V CA	115V CA	24V CA (+/-10%)	24V CC (+/- 20%)	230V CA	115V CA	24V CA (+/-10%)	24V CC (+/- 20%)
Frequenza nominale	50/60 Hz				50/60 Hz			
Campo di funzionamento	187 – 255 V CA	90 – 135 V CA	21,6 – 26,4 V CA	19,2 – 28,8V	187– 255 V CA	90 – 135 V CA	21,6 – 26,4 V CA	19,2 – 28,8V
Consumo di corrente (max.) luce flash (1Hz) [mA]	170	350	970	670	170	350	970	670
Consumo di corrente nominale luce flash (1Hz) [mA]	150	300	890	540	150	300	890	540
Consumo di corrente segnalatore acustico [mA]	-	-	-	-	50 Hz: 10 – 25	60 Hz: 10 – 20	50/60Hz: 40	20
Potenza assorbita	34,5 VA	34,5 VA	22 VA	13 W	38 VA	36,5 VA	23 VA	13,5 W
Fattore di servizio	100%							
Morsetti	0,14 - 2,5mm ² cavo flessibile / AWG24 - AWG 14 (trefolo)							
Grado di protezione	IP66 (EN60529), Tipo 4 & 4x							
Resistenza agli urti	IK 08 (EN50102)							
Classe di protezione	II							
Temperatura di servizio	-40°C...+55°C (UL certificato vedere pagina 6)							
Temperatura di stoccaggio	-40 °C...+70 °C							
Max. umidità relativa dell'aria	90 %							
Ingresso cavi	4x M20 predisposti				4x M20 predisposti			
Intervallo di serraggio passacavo	7 – 13 mm - In caso di utilizzo di cavi di diametro < 7 mm bisogna prevedere un raccordo pressacavo con un grado di protezione adeguato							
Materiale custodia	Miscela PC/ABS							
Materiale calotta	PC							
Posizione di montaggio	A piacere							
Opzioni	- Ingresso di attivazione, -SSM (modulo soft start, solo 24V CC)							
Colori calotta	Trasparente neutro, bianco, giallo, arancione, rosso, verde, blu							

Omologazioni

Omologazioni (solo per dispositivi con marcatura)	
UL, cUL In preparazione	PBV22015 + PBV22015-SON: UCST, UCST7, UEES, UEES7 (ulteriori informazioni a pagina 6)

Messa in funzione

Precauzioni da adottare:

- Il collegamento elettrico deve essere realizzato esclusivamente ad opera di personale autorizzato e in conformità alle prescrizioni attualmente in vigore.
- Pericolo: presenza di alta tensione.
- Prima dell'apertura accertarsi che l'apparecchio non sia sotto tensione.
- Prima della messa in funzione verificare la tensione di alimentazione riportata sulla targhetta identificativa. Una tensione d'esercizio errata può provocare danni al dispositivo o la distruzione dello stesso.
- In fase d'installazione controllare il cavo di collegamento al fine di prevenirne la trazione e la torsione.
Attenzione: questi segnalatori non sono progettati per un uso mobile.
- **AVVERTENZA:** in fase d'installazione mantenere la cavetteria a distanza da componenti interni, angoli e spigoli vivi.
- Il funzionamento dell'apparecchio è garantito solo se la sezione superiore e la sezione inferiore sono collegate correttamente.
- Per prevenire danni alla vista, non fissare la luce accesa.

Alimentazione CC: Il dispositivo è dotato di protezione per inversione di polarità. Nessuna funzione quando le connessioni sono invertite!

Apertura della custodia:

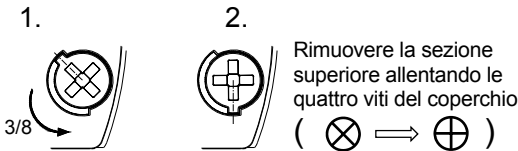

Chiusura della custodia:

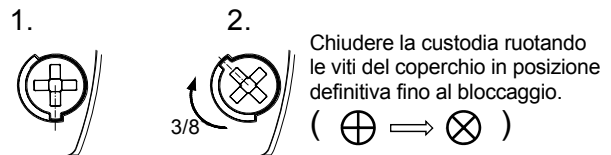

L'apparecchio viene fornito non chiuso.
Come accessori sono disponibili tappi sigillanti per le viti della custodia.

Collegamento elettrico: (Scheda nella sezione inferiore)

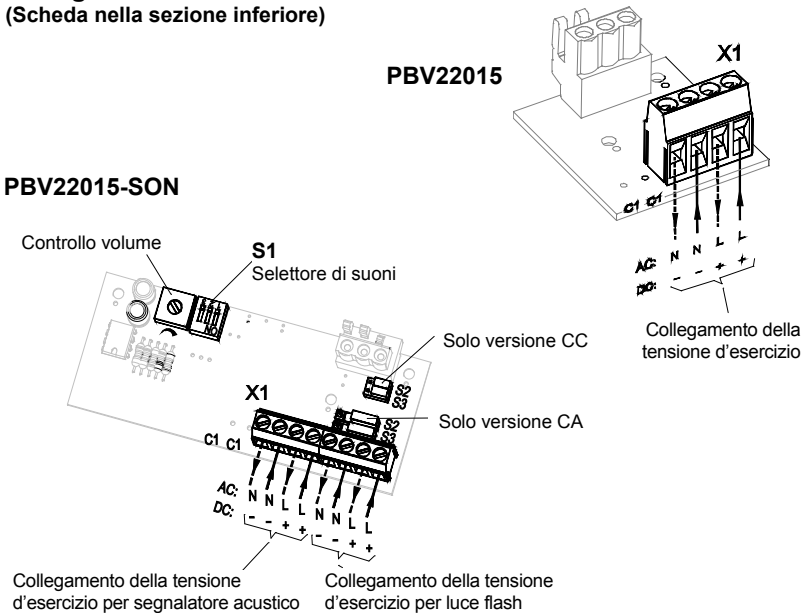

PBV22015-SON



<p>I morsetti del segnalatore acustico sono sotto tensione di esercizio.</p>		**
Funzionamento insieme		<p>S2 *</p> <p>S3</p>
solo "L" insieme		<p>S2</p> <p>S3</p>
solo "N" insieme		<p>S2</p> <p>S3</p>
Funzionamento diviso		<p>S2</p> <p>S3</p>

* Impostazione di fabbrica

** I dispositivi combinati (PBV22015-SON) lampeggiante e sirena possono essere azionati insieme o in modo indipendente.
Vedi schema S2 e S3.

Opzione SSM (modulo soft start, solo 24V CC):

- Limitazione della corrente allo spunto a:

PBV22015(-SON) -SSM:	 : max. 4,25 A	 : max. 4,25 A
-----------------------------	---	---

- Commutazione della tensione d'esercizio al dispositivo solo a partire da > 7V
 - Resistenza per il monitoraggio cavi collegata

Intervallo della tensione d'esercizio: 19,2 – 28,8V DC

Installazione di una resistenza per monitoraggio cavi: (solo versioni CC)

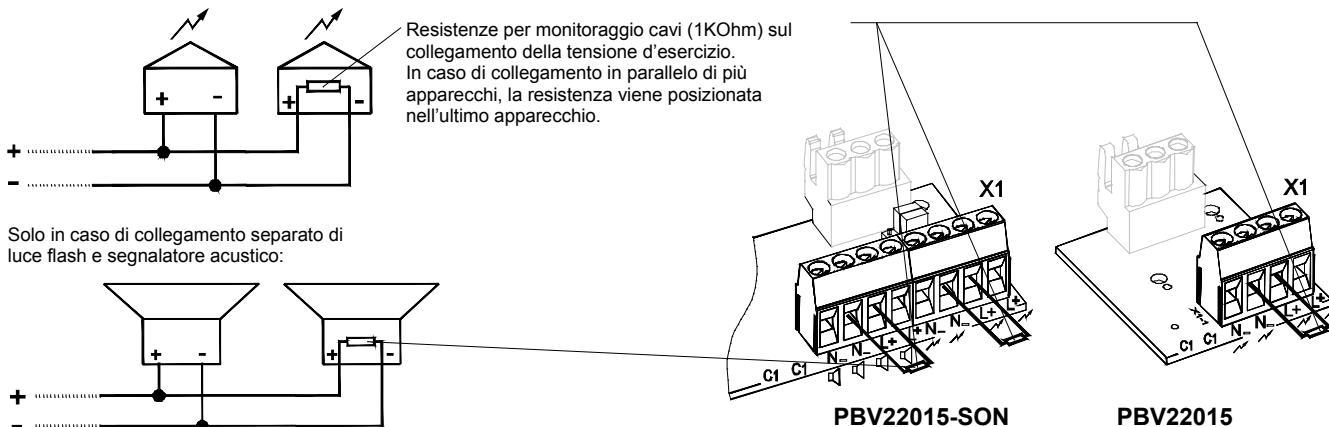

Impostazione frequenza flash:



* Impostazione di fabbrica

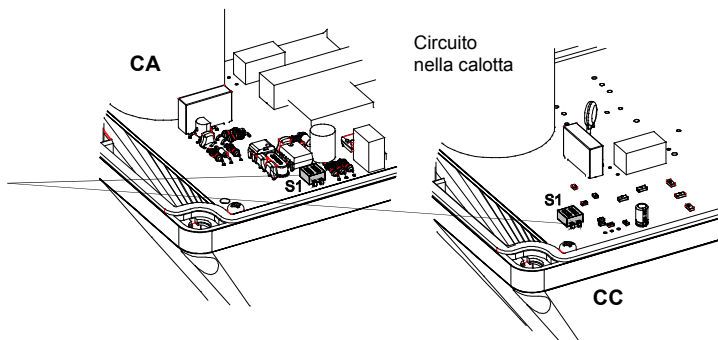









Nota: A secondo della frequenza regolata, il primo flash può avere un ritardo di 10 s.

Sincronicità:

I segnalatori soddisfanno i requisiti EN54-23 (sincronizzazione).

Attenzione: Per garantire una sincronizzazione, le apparecchiature devono operare con lo stesso potenziale.

Impostazione delle tonalità (per PBV22015-SON):

2	Dente di sega DIN 33404-3 (segnale di emergenza) PFEER PTAP	1200 Hz 500 Hz		ON OFF 1 2 3 OFF OFF OFF	161	Suono continuo	3000 Hz		ON OFF 1 2 3 OFF OFF OFF
9	Suono ascendente Allarme incendio UK BS5839-1	970 Hz 800 Hz		ON OFF 1 2 3 OFF OFF OFF	162	Suono intermittente	3000 Hz		ON OFF 1 2 3 OFF OFF OFF
131	Suono alternante UK BS5839-1, Allarme incendio Pas- saggio a livello	1000 Hz 800 Hz		ON OFF 1 2 3 OFF OFF OFF	163	Suono intermittente	3000 Hz		ON OFF 1 2 3 OFF OFF OFF
160	Suono continuo (Corno)	110 Hz		ON OFF 1 2 3 OFF OFF OFF	164	Suono ascendente	2850 Hz 2400 Hz		ON OFF 1 2 3 OFF OFF OFF

* Impostazione di fabbrica, selettore di suoni S1 sulla parte inferiore del circuito, vedere capitolo „installazione elettrica“

Luce flash con ingresso di attivazione:

Questa opzione permette l'attivazione della luce flash tramite il controllo della tensione. L'ingresso di attivazione è max. 1W.

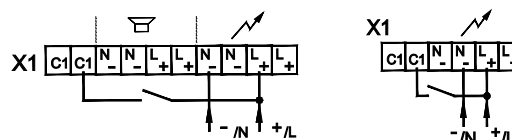

Passaggi per cavi:

Per garantire il grado di protezione indicato occorre montare passaggi per cavi con un grado di protezione IP 66 nelle aperture appositamente previste. Il nipplo a membrana fornito può essere sostituito da un raccordo pressacavo o da un connettore M12 con flangia M20.

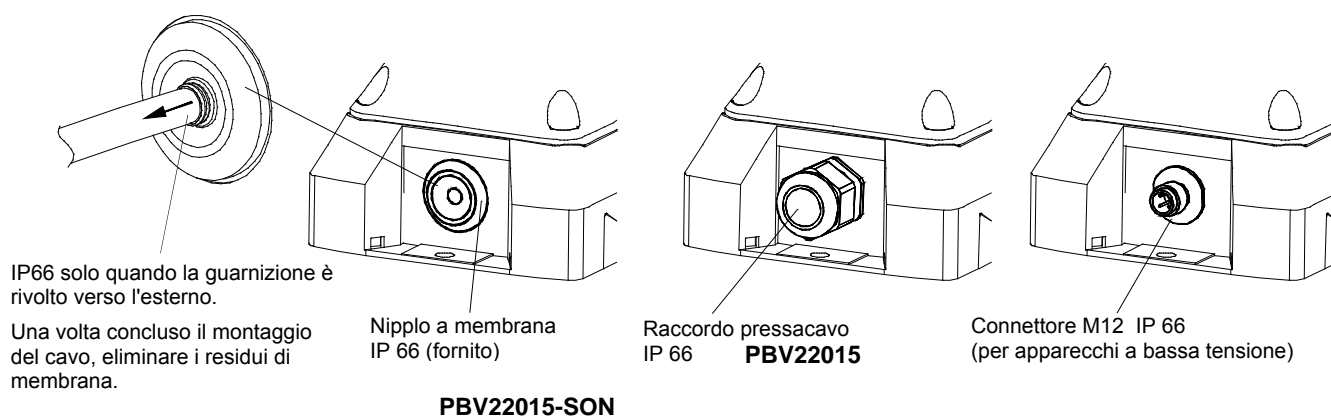

Accessori

Tappi sigillanti, confezione da 4	n° art. 28300000002
Tenuta superficiale PBV22015	n° art. 28111500002
Tenuta superficiale PBV22015-SON	n° art. 28111500001

Manutenzione, assistenza, riparazione

L'apparecchio non necessita di una particolare manutenzione. Per la pulizia esterna utilizzare un detergente neutro senza solventi.

Il segnalatore acustico può essere utilizzato solo se perfettamente integro e nel rispetto dei dati tecnici specificati. Eventuali modifiche e alterazioni così come l'impiego errato o non consentito e il mancato rispetto delle istruzioni riportate nel presente manuale comportano l'esclusione della garanzia.

Per eventuali sostituzioni di componenti utilizzare solo pezzi di ricambio originali. Gli interventi di riparazione vengono effettuati in linea di massima presso l'officina del costruttore.

