

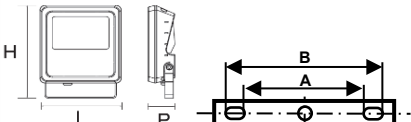







	<h1>TWISTER 3</h1> <h2>25 / 45 Tuya</h2>			Code /Réf
				51318
				51319

220-240V~50/60Hz	IP65	IK08					480 h BS	RGBW				
------------------	------	------	---	---	---	---	----------	------	---	---	---	---

Code / Ref	P (w)	 (Kg)	L (mm) ±1	H (mm) ±1	P (mm) ±1	A (mm)	B (mm)	CxS max (m²)
51318	24.2	0.62	140	188	45	55	81	0.026
51319	44.9	1	162	205	45	56	109	0.033

FR Ce produit contient une source lumineuse de classe d'efficacité énergétique EN This product contains a light source of energy efficiency class DE Dieses Produkt enthält eine Lichtquelle der Energieeffizienzklasse IT Questo prodotto contiene una sorgente luminosa di classe di efficienza energetica ES Este producto contiene una fuente luminosa de la clase de eficiencia energética	D	  
--	----------	---

 Ne jetez pas vos déchets électriques avec les déchets ménagers. Confiez votre appareil à votre centre de recyclage pour son traitement approprié. Waste electrical products must not be disposed of with household waste. This tool should be taken to your recycling center for safe treatment. Dieses Gerät darf nicht mit dem Hausmüll/Restmüll entsorgt werden. Das Altgerät nur in einer öffentlichen Sammelstelle abgeben. I rifiuti elettrici non devono essere smaltiti con i rifiuti domestici. Questo strumento deve essere portato al centro di riciclaggio per un trattamento sicuro. Los productos eléctricos de desecho no deben ser eliminados con residuos domésticos. Esta herramienta debe ser llevada a su centro de reciclaje para un tratamiento seguro. Si le câble ou le cordon extérieur souple de ce luminaire est endommagé, il doit être remplacé exclusivement par le fabricant ou son agent de maintenance ou toute personne de qualification équivalente, cela afin d'éviter tout risque. If the external flexible cable or cord of this luminaire is damaged, it shall be exclusively replaced by the manufacturer or his service agent or a similar qualified person in order to avoid a hazard. Ist das äußere flexible Kabel oder Kabel dieser Leuchte beschädigt, so ist es ausschließlich durch den Hersteller oder seinen Kundendienst oder eine ähnlich qualifizierte Person zu ersetzen, um eine Gefahr zu vermeiden. Se il cavo o il cavo flessibile esterno di questo apparecchio di illuminazione è danneggiato, esso deve essere sostituito esclusivamente dal fabbricante o dal suo agente di servizio o da una persona qualificata analoga al fine di evitare un pericolo. Si el cable o cable flexible externo de esta luminaria está dañado, será sustituido exclusivamente por el fabricante o su agente de servicio o una persona cualificada similar a fin de evitar riesgos.	 Suivez la fiche d'instructions pour garantir un fonctionnement fiable et sécurisé. À conserver pour consultation ultérieure. Les produits doivent être installés par un électricien qualifié conformément aux normes internationales de câblage. Follow Instruction Sheet to ensure safe and reliable operation. Retain for future reference. Products should be installed by a qualified Electrician in accordance with International Wiring Regulations. Die Gebrauchsanweisung befolgen, damit der sichere und zuverlässige Betrieb gewährleistet ist. Zum späteren Nachschlagen aufheben. Die Produkte müssen von einem qualifizierten Elektriker in Übereinstimmung mit den relevanten Vorschriften installiert werden. Seguire il foglio delle istruzioni per garantire il funzionamento sicuro e affidabile. Conservare per riferimento futuro. I prodotti devono essere installati da un elettricista qualificato conformemente alle normative internazionali sui cablaggi. Siga la hoja de instrucciones para garantizar la seguridad y un funcionamiento fiable. Consérvela para utilizarla como material de referencia en el futuro. Los productos los debe instalar un técnico electricista cualificado en virtud de las normativas internacionales en materia de cableado.	
FR  La source lumineuse contenue dans ce luminaire ne doit être remplacée que par un employé de Aric, un agent ou une personne qualifiée. EN The light source contained in this luminaire must only be replaced by an Aric employee, an agent or a qualified person. DE Die Lichtquelle in dieser Leuchte darf nur durch einen Aric-Angestellten, einen Agenten oder eine qualifizierte Person ersetzt werden. IT La sorgente luminosa contenuta in questo apparecchio deve essere sostituita soltanto da un dipendente di Aric, da un agente o da una persona qualificata. ES La fuente luminosa contenida en esta luminaria sólo será sustituida por un empleado de Aric, un agente o una persona cualificada.	FR Vérifier la qualité de la connexion Wifi avant d'installer le projecteur. EN Check the quality of the WiFi connection before installing the projector. DE Überprüfen Sie die WLAN-Qualität vor der Installation des Projektors. IT Controllare la qualità della connessione WiFi prima di installare il proiettore. ES Compruebe la calidad de la conexión Wifi antes de instalar el proyector.	 



230 V AC

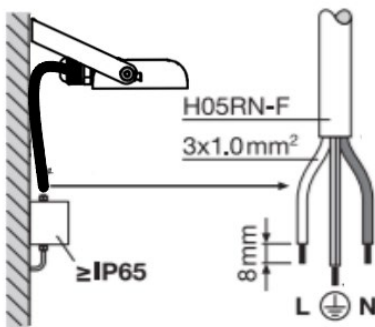

1
Installer
Install

Register Enter Verification Code Set Password

Votre adresse email Code de vérification Password contains 6 to 20 characters, including letters and digits

Click email @--> Code de vérification → Mot de

Pour plus d'information, Lien pour application Tuya smart App
For more information, Link for Tuya smart App

<https://images.tuyacn.com/app/appguide/3.13.pdf>

FAQ et commentaires accessibles à partir de profil
FAQ & Feedback accessible from profil

2

Ajouter un équipement
Add a device.

Activez le Bluetooth de votre téléphone
Turn on Bluetooth on your phone

3

La lampe doit clignoter rapidement
Light must rapidly flashing, if not, please reinitialize.

Réinitialiser
Reinitialize
On/off: x 3

4

Sélectionnez Réseau Wi-Fi 2,4 GHz et entrez le mot de passe.
If your Wi-Fi is 5 GHz, please configure to 2.4 GHz. Method: Go to network settings.

5

Détection du produit automatique.
Automatic lamp detection.
Si échec réinitialisez la lampe
If not reinitialize the lamp

6

1 périphérique trouvé. Ajout de 1 avec succès.

8

Allumer
Switch ON

9

Contrôler CCT
CCT control

10

Contrôler la couleur
RGBW control