

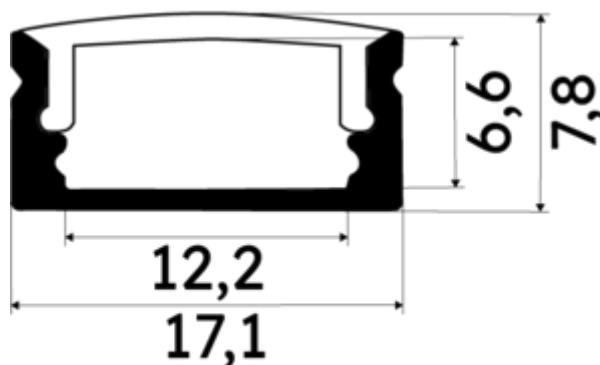

PR1005B-GRIS

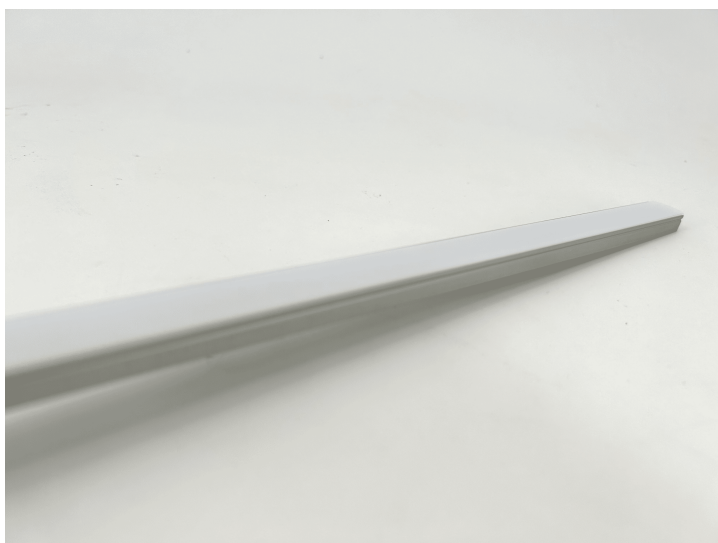

Caractéristiques techniques





LARGEUR	17,1mm
LARGEUR INTÉRIEURE	12,2mm
HAUTEUR	0,78 cm
MATIÈRE	Aluminium
POIDS	133g/m
ACCESSOIRE INCLUS	Diffuseur
CONDITIONNEMENT	1



Références

NOM COMMERCIAL RÉF. CONSTRUCTEUR	LONGUEUR	TYPE DE CAPOT	COULEUR DU PRODUIT
PR1005B-GRIS ENG030000000239	200,0 cm	Opaque	Gris
PR1005B-GRIS-3M ENG120000000134	300,0 cm	Opaque	Gris
PR1005B-GRIS-SP ENG031000000205	1,0 cm	Opaque	Gris

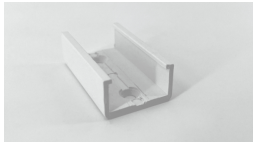
Accessoires associés non inclus

NOM COMMERCIAL RÉF. CONSTRUCTEUR	DESCRIPTION	COULEUR	MATIERE	ILLUSTRATION
PR1006-2 ENG0309902000004	PR1006 CLIPS DE FIXATION DE FIXATION VENDU PAR LOT DE DEUX UNITES COMPATIBLE PR1005	Gris	Inox	
PR1005-6 ENG0309902000061	PR1005 CLIPS DE FIXATION ROTATIFS ALUMINIUM VENDU PAR LOT DE 2 POUR PROFILÉ PR1005	Gris		
PR1005-4 ENG0309906000121	PR1005 CONNECTEUR D'ANGLE 180 DEGRES EN MATIERE PLASTIQUE DE COLORIS TRANSPARENT VENDU A L'UNITE	Blanc	Plastique	
PR1005-3 ENG0309902000060	PR1005 CLIPS DE FIXATION ANGLE 90 DEGRES EN MATIERE PLASTIQUE VENDU PAR LOT DE DEUX UNITES	Transparent		



NOM COMMERCIAL RÉF. CONSTRUCTEUR	DESCRIPTION	COULEUR	MATIERE	ILLUSTRATION
PR1005-2 ENG0309902000003	PR1005 CLIPS DE FIXATION EN MATIERE PLASTIQUE DE COLORIS TRASNSPARENT VENDU PAR LOT DE DEUX UNITES	Gris	Polycarbonate	
PR1005-1 ENG0309901000003	PR1005 BOUCHON DE FINITION EN MATIERE PLASTIQUE DE COLORIS GRIS VENDU PAR LOT DE DEUX UNITES	Gris	Polycarbonate	