

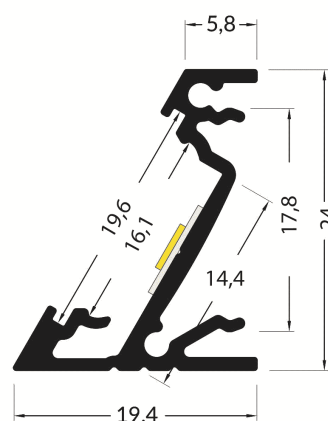

PR2009F

Profilé d'angle



Caractéristiques techniques



LARGEUR	24mm
LARGEUR INTÉRIEURE	14,4mm
HAUTEUR	19,4mm
MATIÈRE	Aluminium
POIDS	236g/m, 259g/m
ACCESSOIRE INCLUS	Diffusant polycarbonate
CONDITIONNEMENT	1 pièce







Références

NOM COMMERCIAL RÉF. CONSTRUCTEUR	LONGUEUR	COULEUR DU PRODUIT
PR2009F-BLANC ENG0300000000067	2m	Blanc
PR2009F-GRIS ENG0300000000068	2m	Gris
PR2009F-NOIR ENG0300000000071	2m	Noir
PR2009F-GRIS-3M ENG0300000000069	3m	Gris
PR2009F-BLANC-SP ENG0310000000062	Sur mesure	Blanc
PR2009F-GRIS-SP ENG0310000000063	Sur mesure	Gris
PR2009F-NOIR-SP ENG0310000000065	Sur mesure	Noir

Accessoires associés non inclus

NOM COMMERCIAL RÉF. CONSTRUCTEUR	DESCRIPTION	COULEUR	MATIERE	ILLUSTRATION
PR2009-1-BLANC ENG0309901000057	Kit de 2 bouchons blancs	Blanc	ABS	
PR2009-1-GRIS ENG0309901000058	Kit de 2 bouchons gris	Gris	ABS	



NOM COMMERCIAL RÉF. CONSTRUCTEUR	DESCRIPTION	COULEUR	MATIERE	ILLUSTRATION
PR2009-1-NOIR ENG0309901000059	Kit de 2 bouchons noirs	Noir	ABS	
PR2009-5-90-BLANC ENG0309906000038	Connecteur 90°	Blanc	Aluminium	
PR2009-5-90-GRIS ENG0309906000039	Connecteur 90°	Gris	Aluminium	
PR2009-5-90-NOIR ENG0309906000040	Connecteur 90°	Noir	Aluminium	
PR2000-2Y2 ENG0309902000030	Kit de 2 clips Y	Gris	Inox	
PR2000-5-180T ENG0309906000003	Connecteur 180°	Gris	Aluminium	