

ULTRALED JOUR II ES

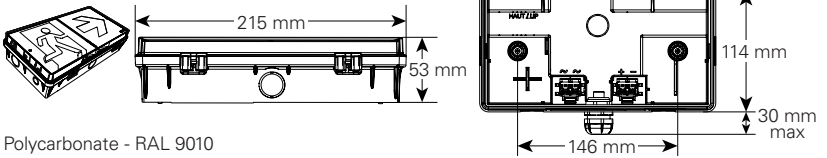

Polycarbonate - RAL 9010

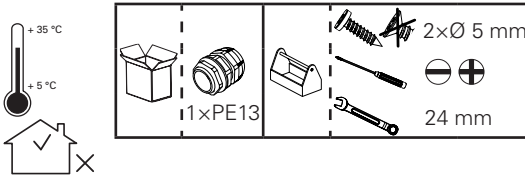
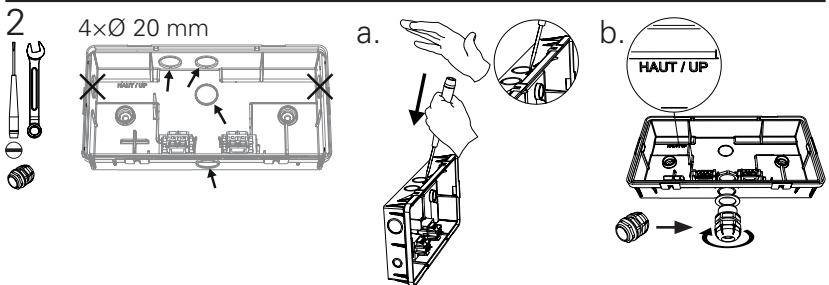
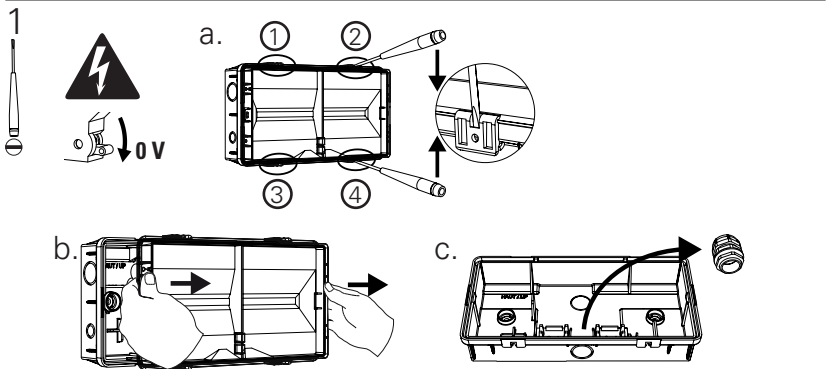

Powering Business Worldwide

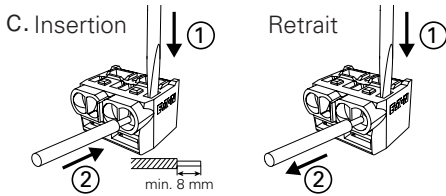
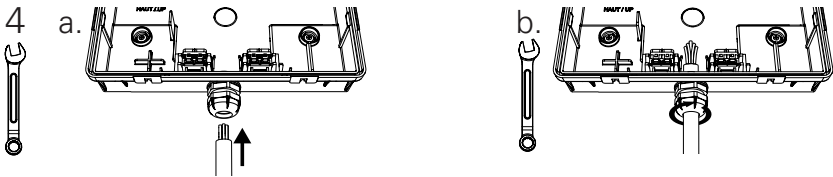
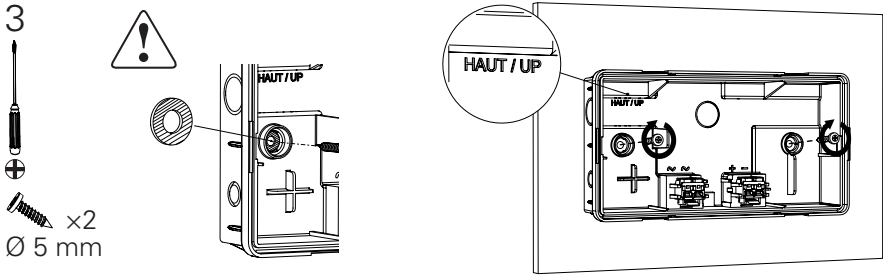

Câble rigide ou souple
 $0,5 < S < 2,5 \text{ mm}^2$

Si câble rigide
 $1,5 < S < 2,5 \text{ mm}^2$

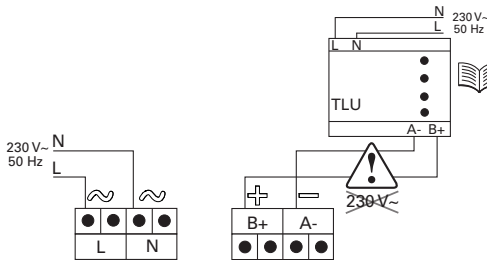
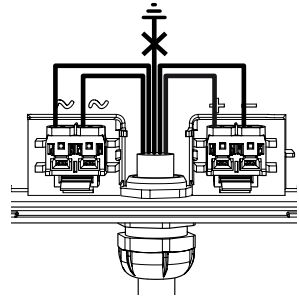

Voir
 LUM10312



LUM10312

AA SS > 1527

AA : Année
 SS : Semaine

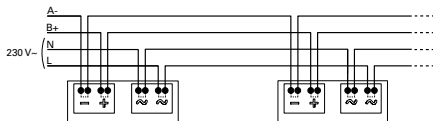

5

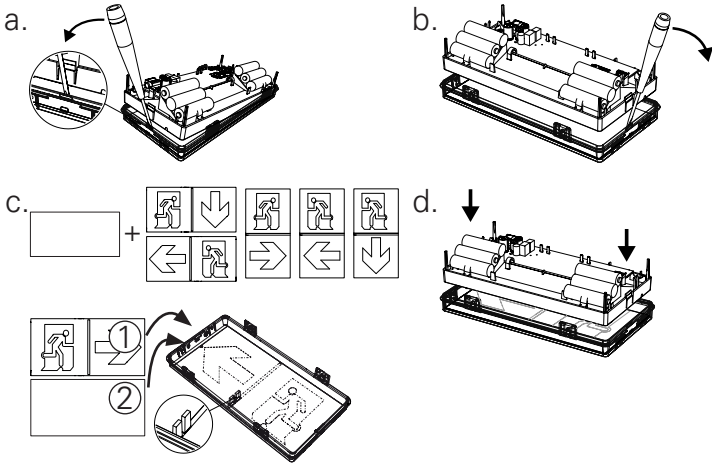

6

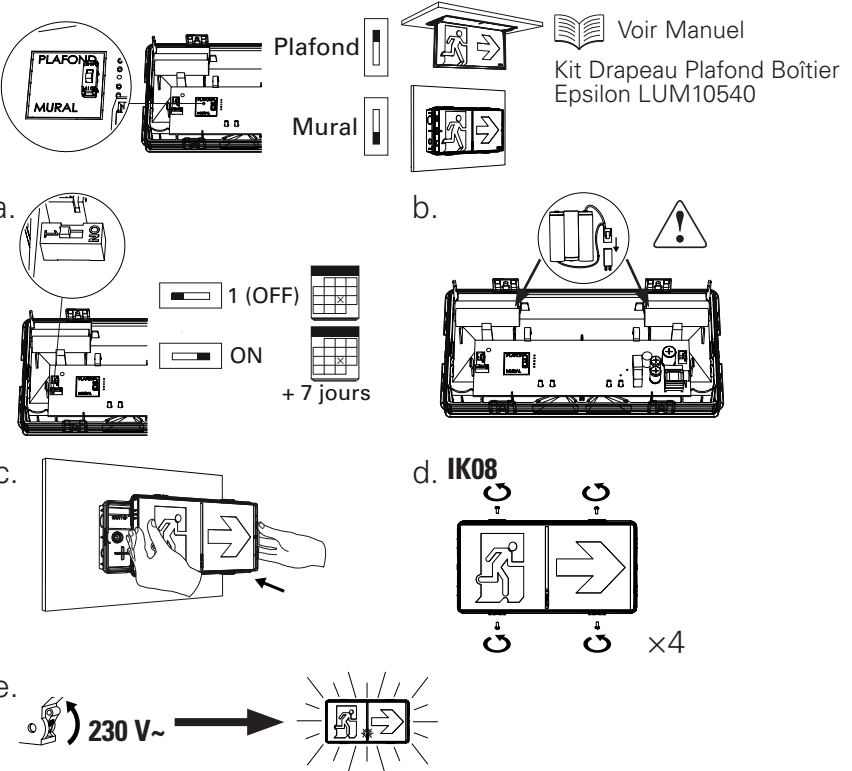

Autotest

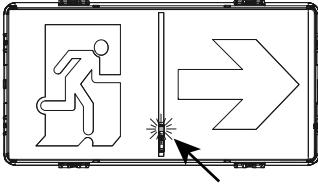

V		OK
V		Test
V/J		com
J		2 s
J		0,5 s

Test

charge

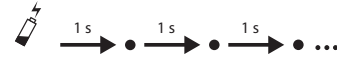

lampe



batterie



→ À remplacer Réf. LUM11048



Non remplaçable

Cooper Sécurité SAS (Groupe EATON) s'engage à assurer la pérennité des pièces consommables (lampes et batteries) pendant 8 ans à compter de la date de la dernière mise sur le marché du produit.

Programmation de l'heure des tests

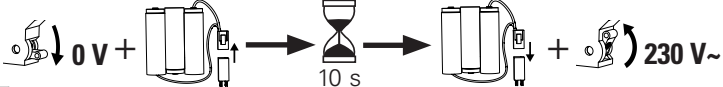

ou

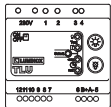

TLU
LUM10312
AA SS>1527

ULTRALED JOUR II ES	NF	IP/IK	BAES/BAEH	BAES	BAEH	EN	FR
LUM1616Z	T16123	66/08	2 Packs 3 x 1,2 V/0,6 Ah Ni-Cd Ronda Ref. LUM11048	1h 45m	5h 8m	8 x LED 3,6 V 30 mA	8 x LED 3,6 V 30 mA
						2 x LED 35 mA 4 x LED 20 mA	2 x LED 35 mA 4 x LED 20 mA
						230 V-50-60 Hz 0,98 W	230 V-50-60 Hz 0,98 W
						NFEN 60598-1 NFEN 60598-2,ZZ	NFEN 60598-1 NFEN 60598-2,ZZ
						C 71820-1 (NFEN 62004)	C 71820-1 (NFEN 62004)
						NF-413	NF-413
						NFC 71803	NFC 71803

Eaton
EMEA Headquarters
Route de la Longeraie 7
1110 Morges, Switzerland
Eaton.eu

La collecte, le traitement et le recyclage des DEEE Pro et accumulateurs incorporés, de Cooper Sécurité SAS (Groupe EATON), sont assurés gratuitement par Recylum. Plus d'informations sur : www.recylum.com



EATON

Powering Business Worldwide

Eaton
Cooper Sécurité SAS
PEE II - Rue Beethoven - BP10184
63204 RIOM CEDEX FRANCE
Tél. +33 (0)825 826 212 (0,15 € TTC/min)
www.cooperfrance.com
www.eaton.com

© 2016 Eaton
ZNO2035000 A - 12/2016
Tous droits réservés

