

# Kit d'encastrement Ultraled 2-400 ES & Planete 2-400 ES

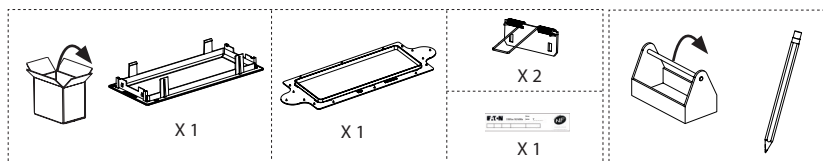

1

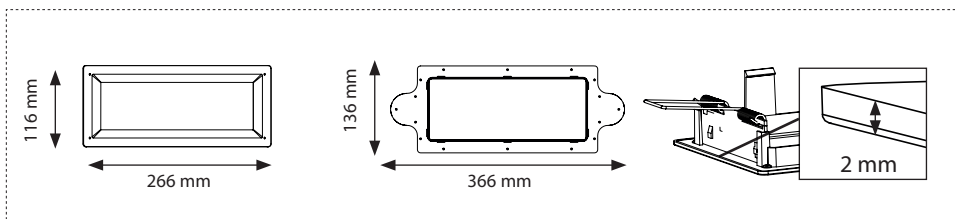
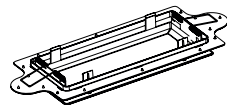
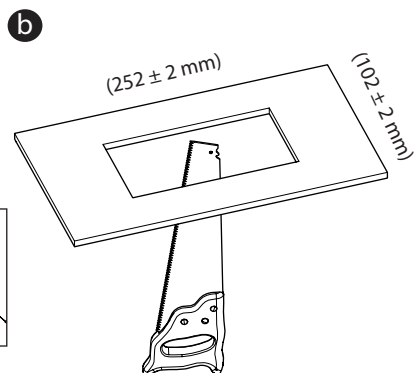
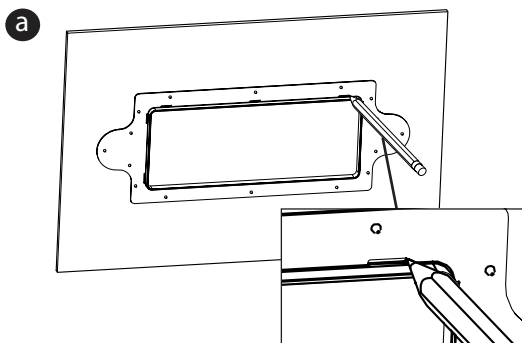
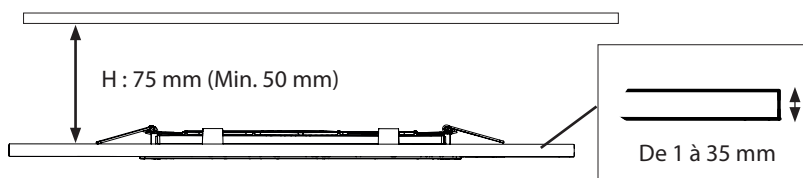

**C**

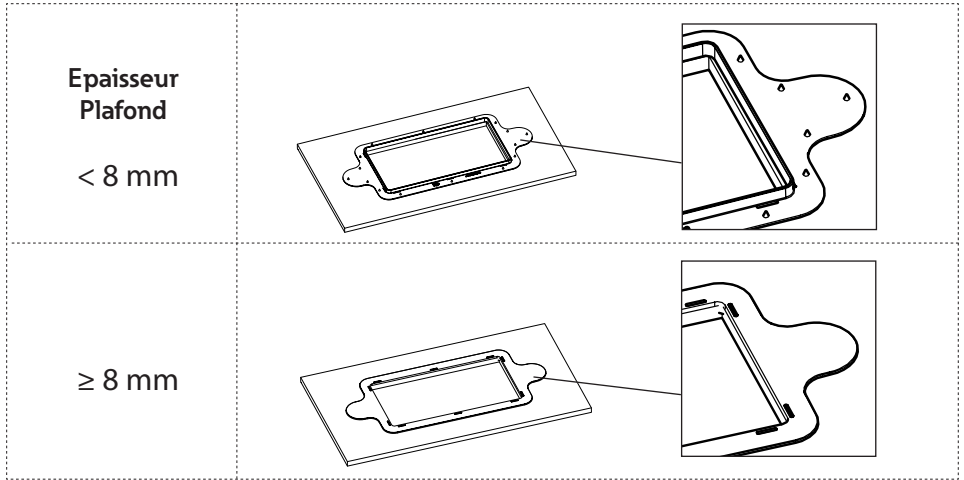

**2**

**a**

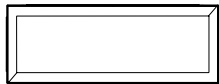

**Blocs Ultraled 2-400 ES - LUM1614Z**  
**Planete 2-400 ES- LUM17247**  
**Planete 2-220/400 ES CG-S - LUM22765**

Voir la notice du luminaire pour le câblage et l'installation complète.

**b**

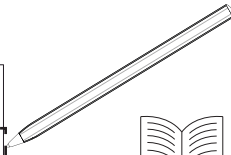
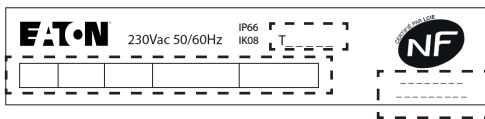

Voir étiquette du produit.

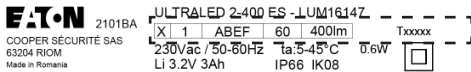

**C**

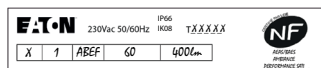
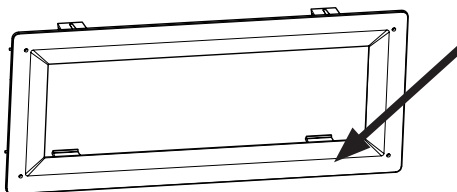

3

a

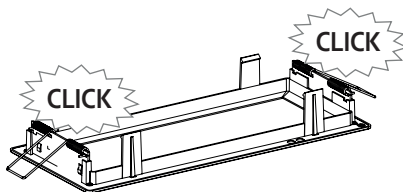
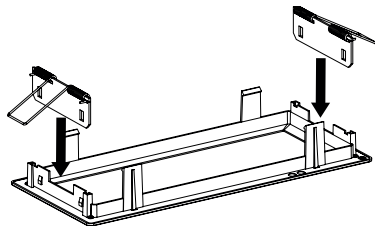

b

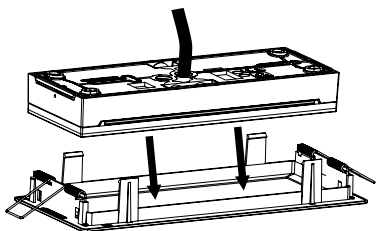

c

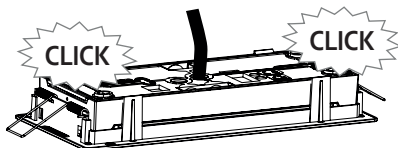

d

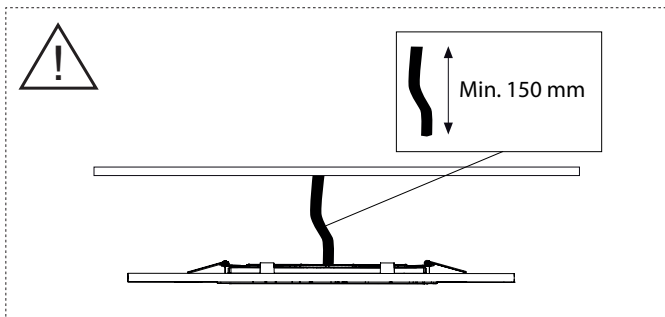
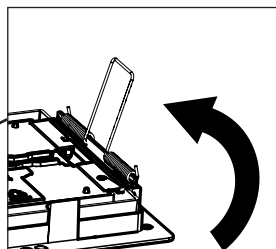
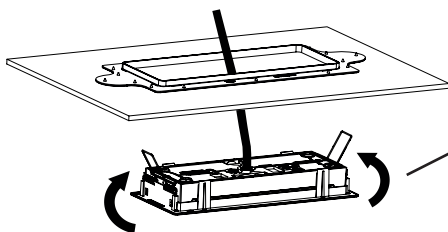

e

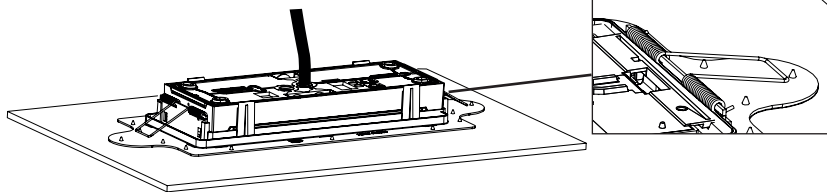

Eaton  
Cooper Sécurité SAS  
PEE II - Rue Beethoven - BP10184  
63204 RIOM CEDEX FRANCE  
Tél. +33 (0)825 826 212 (0,15 € TTC/min)  
[www.cooperfrance.com](http://www.cooperfrance.com)  
[www.eaton.com](http://www.eaton.com)

Eaton  
EMEA Headquarters  
Route de la Longeraie 7  
1110 Morges, Switzerland  
Eaton.eu

© 2020 Eaton  
All Rights Reserved



DEEE: Contactez votre revendeur  
[Eaton.com/recycling](http://Eaton.com/recycling)



ZNO2055200 A- 11/2020

Eaton is a registered trademark.

All trademarks are property  
of their respective owners.



**EATON**

Powering Business Worldwide