

# PLANETE 45 ADR CGLine+

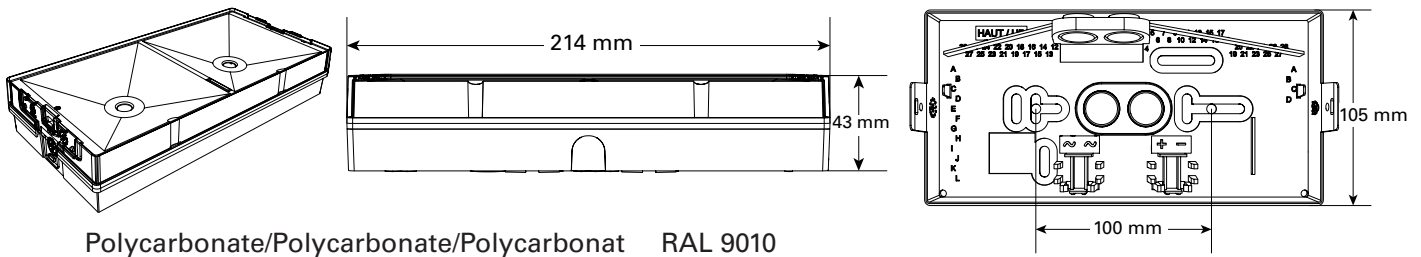

+ centrale de gestion web/web-controller/web-controller ADR 1L511/CGLine+

AEAS  
www.lcie.fr

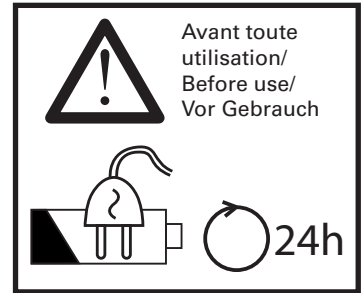
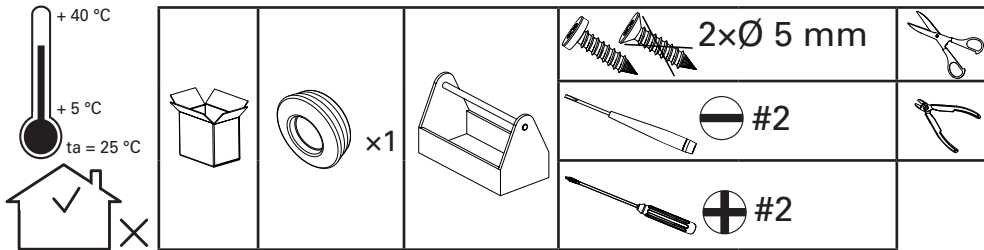

Polycarbonate/Polycarbonate/Polycarbonat RAL 9010

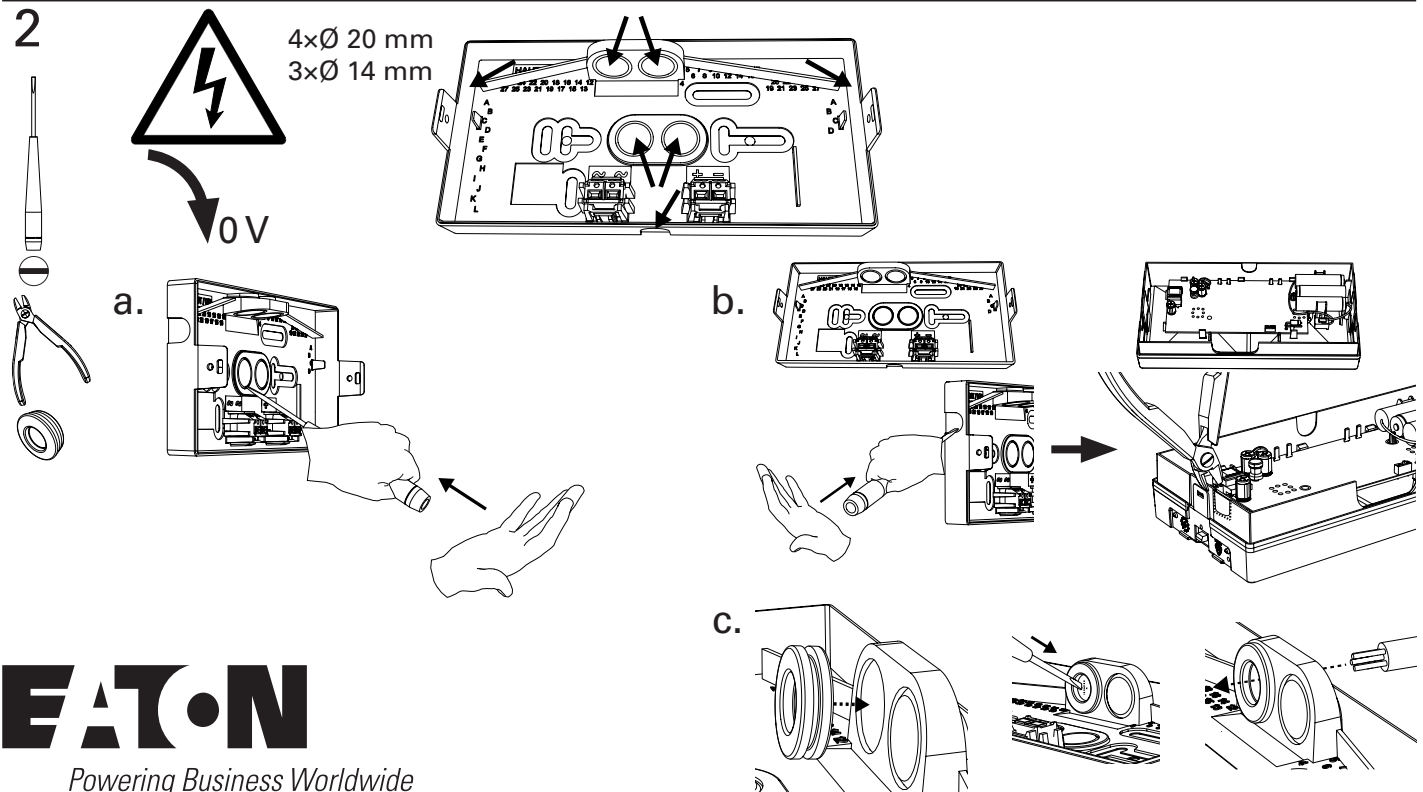
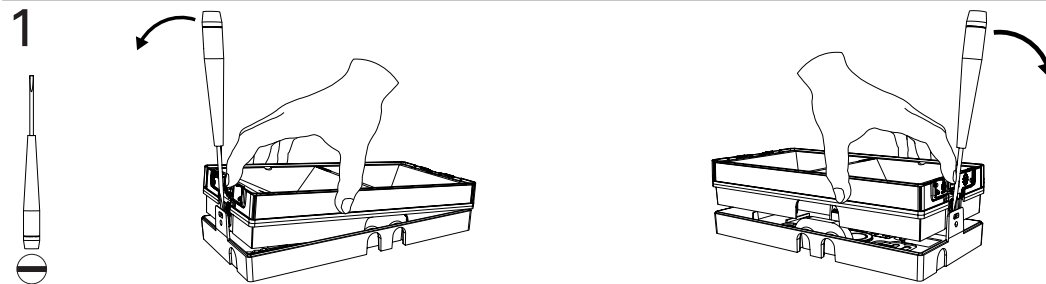

3

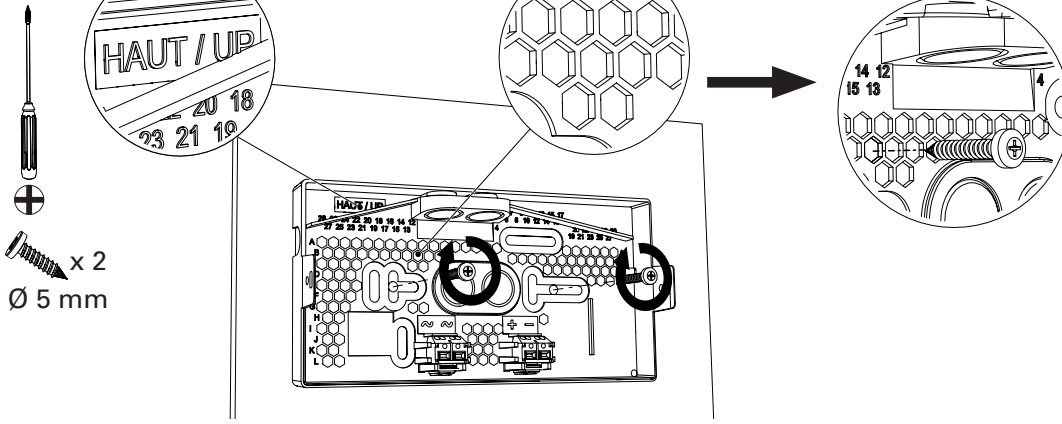

4

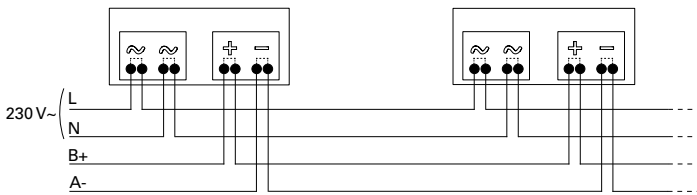
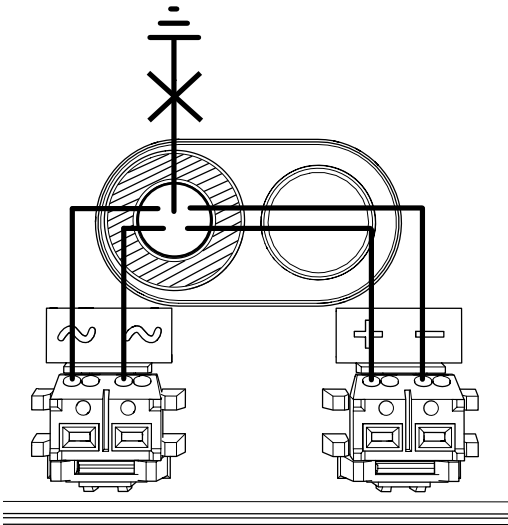
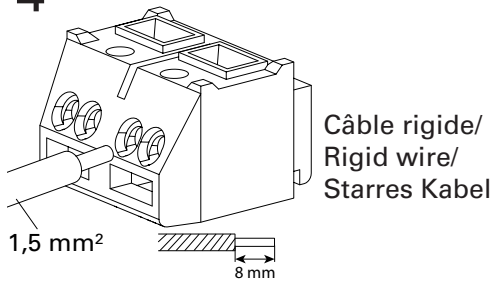

# 5

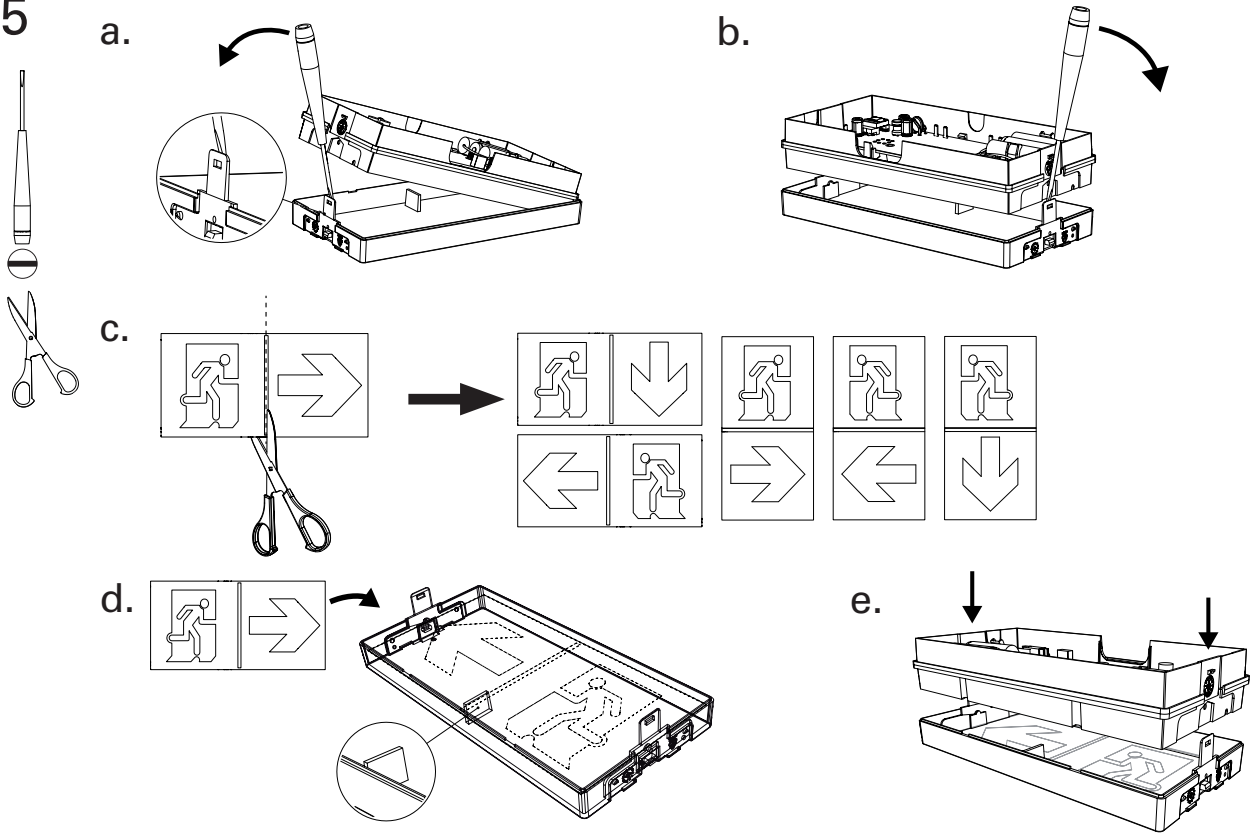

# 6

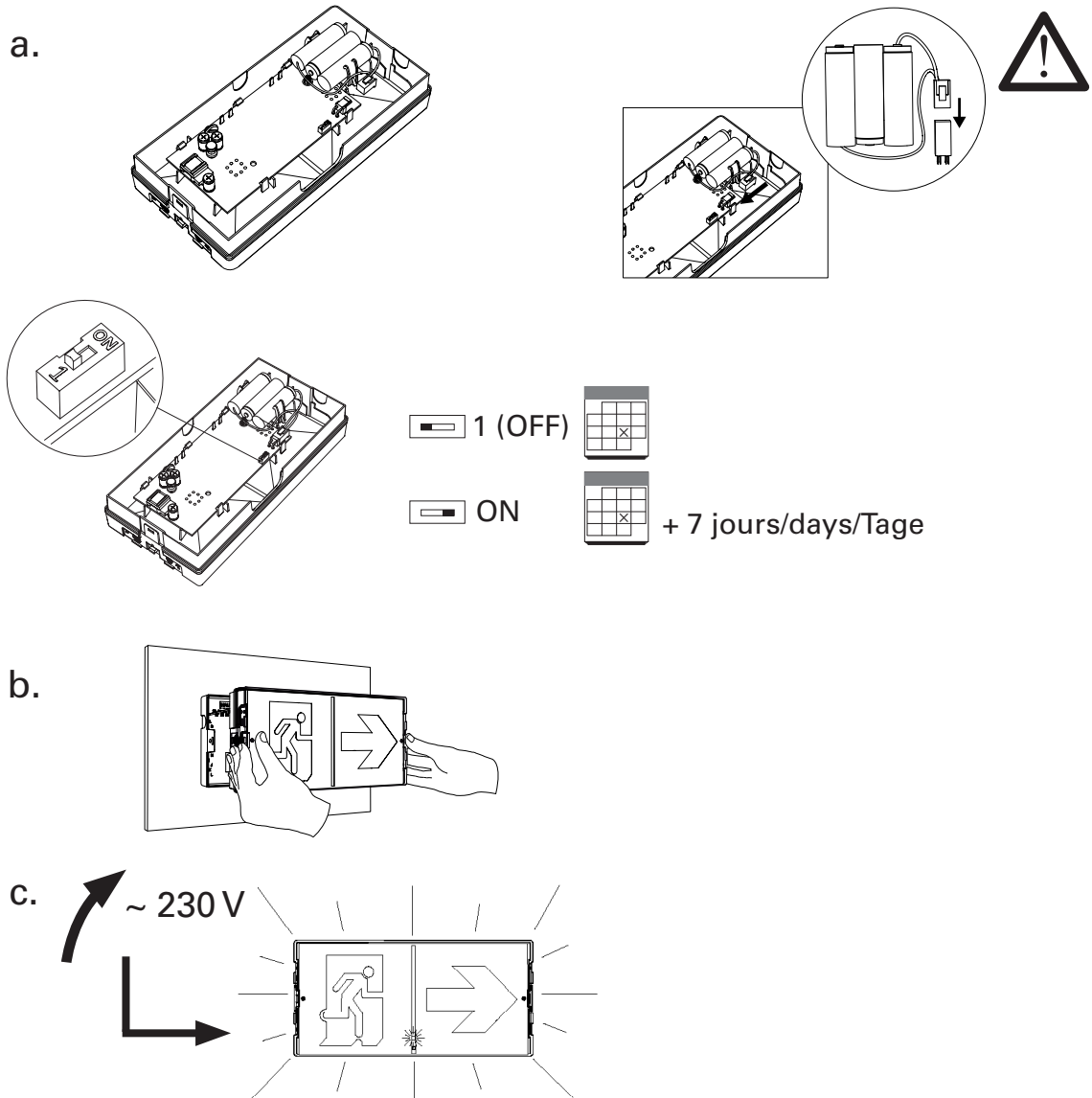

# Autotest / SATI

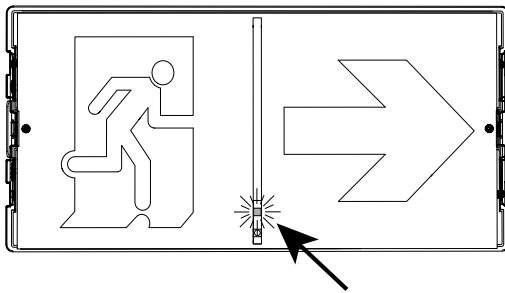

V/G/Gr		OK
V/G/Gr		Test
V/J / G/Y / Gr/Ge		·)))))) com/com/kom
J/Y/Ge		2 s
J/Y/Ge		0,5 s

## Test

charge/charge/Ladung

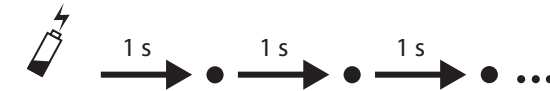

lampe/lamp/Lampe

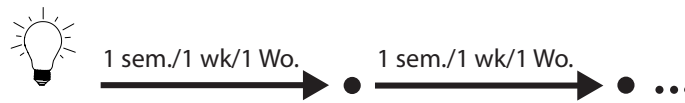

batterie/battery/Batterie

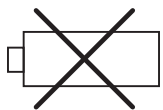

À remplacer/  
To be replaced/  
Zu ersetzen Ref. AAC7420100

## Programmation de l'heure des tests/Test hour programming/Testdatumprogrammierung

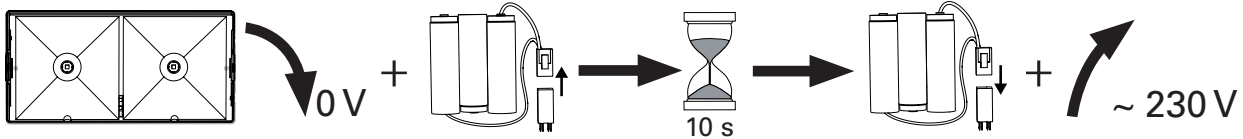

ou/or/oder

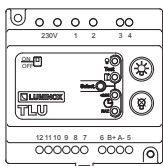

TLU  
LUM10312

	NF						EN	FR	
PLANETE 45 ADR CGLine+	LUM17114	T15002	43/08	h	Im	U	P		
			Pack 3 x 1,2 V/0,6 Ah Ni-Cd EATON EcoSafe by SAFT Ref. AAC7420100	1	45	230 V~/50-60 Hz	0,6 W	NFEN 60598.1 NFEN 60598.2.22	NFC 71800 NFEN 62034 C 71820-1 (NFEN 62034) NF 413
					2 x LED 3,6 V 170 mA				

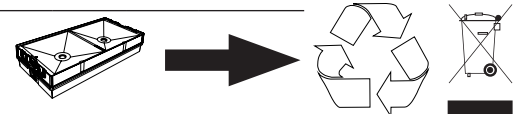

Eaton  
Cooper Sécurité SAS  
PEE II - Rue Beethoven - BP10184  
63204 RIOM CEDEX FRANCE  
Tél. +33 (0)825 826 212 (0,15 € TTC/min)  
www.cooperfrance.com  
www.eaton.eu

FR : [www.recylum.com](http://www.recylum.com)

© 2015 Eaton  
Tous droits réservés.  
All rights reserved.  
Alle Rechte vorbehalten.

