



Lfv330-XXNBVXNR0300

Lfv300

VIBRATING LEVEL SWITCH

SICK
Sensor Intelligence.



Illustration may differ



Ordering information

| Type | Part no. |
|---------------------|----------|
| LFV330-XXNBVXNR0300 | 6058732 |

Other models and accessories → www.sick.com/LFV300

Detailed technical data

Features

| | |
|------------------------------|---|
| Medium | Fluids |
| Measurement | Switch |
| Probe length | 300 mm |
| Process pressure | -1 bar ... 64 bar |
| Process temperature | -50 °C ... +150 °C |
| Fill material density | 0.5 g/cm ³ ... 2.5 g/cm ³ |

Performance

| | |
|-----------------------------------|--------------------------|
| Accuracy of sensor element | ± 2 mm |
| Reproducibility | ≤ 1 mm |
| Viscosity | 0.1 mPas ... 10,000 mPas |
| Response time | 500 ms |
| MTBF | 9,73*10 ⁶ h |

Electronics

| | |
|-------------------------------|---|
| Power consumption | 5 mA ... 30 mA |
| Initialization time | < 2 s |
| VDE protection class 1 | ✓ |
| Connection type | ½" NPT |
| Output signal | Double relay (DPDT) |
| Supply voltage | Double relay (DPDT): 20 V DC ... 72 V DC / 20 V AC ... 253 V AC |
| Hysteresis | 2 mm |
| Output current | > 10 µA; < 3A AC, 1A DC |
| Inductive load | 750 VA 54 W |
| Capacitive load | 750 VA 54 W |
| Contact load | Min. 50 mW / max. 750 VA, 54 W |
| Enclosure rating | IP66 / IP67 |
| Temperature drift | 0,03 mm/K |

Mechanics

| | |
|---------------------------|---|
| Wetted parts | Stainless steel 316L (optional Ra ≤ 0.8 µm) |
| Process connection | ¾" NPT PN 64 |
| Housing material | Plastic |
| Sensor material | Stainless steel 1.4404 |

Ambient data

| | |
|--------------------------------------|-------------------|
| Ambient operating temperature | -40 °C ... +70 °C |
| Ambient temperature, storage | -40 °C ... +80 °C |

Classifications

| | |
|-----------------------|----------|
| ECLASS 5.0 | 27273202 |
| ECLASS 5.1.4 | 27273202 |
| ECLASS 6.0 | 27273202 |
| ECLASS 6.2 | 27273202 |
| ECLASS 7.0 | 27273202 |
| ECLASS 8.0 | 27273202 |
| ECLASS 8.1 | 27273202 |
| ECLASS 9.0 | 27273202 |
| ECLASS 10.0 | 27273202 |
| ECLASS 11.0 | 27273202 |
| ECLASS 12.0 | 27273106 |
| ETIM 5.0 | EC002654 |
| ETIM 6.0 | EC002654 |
| ETIM 7.0 | EC002654 |
| ETIM 8.0 | EC002654 |
| UNSPSC 16.0901 | 41111938 |

Type code

LFV330 type code

Certification

| | |
|----|--|
| XX | Without approval |
| XA | WHG approval |
| CA | ATEX II 1G, 1/2G, 2G Ex ia IIC T6 Ga, Ga/Gb, Gb +WHG |
| DA | ATEX II 1/2G Ex db IIC T6...T2 Ga/Gb +WHG |

Process connection/Material (see below)

Middle section / Process temperature

| | |
|---|------------------------------|
| X | without / -50 °C ... +150 °C |
| T | with / -50 °C ... +250 °C |

Housing / Cable screw connection

| | |
|---|---|
| P | Plastics IP 66, IP 67 / M20 x 1,5 |
| N | Plastics IP 66, IP 67 / ½" NPT |
| M | Aluminium IP 66, IP 67 / M20 x 1,5 |
| U | Aluminium IP 66, IP 67 / ½" NPT |
| V | Stainless steel (precision casting) 316L IP66, IP67 / M20 x 1,5 |
| A | Stainless steel (precision casting) 316L IP 66, IP 67 ½" NPT |
| 8 | Stainless steel (electro buffed) 316L IP 66, IP 67 / M20 x 1,5 |



Not all variations of the type code can be combined! Not all available variations are shown.

Process connection/Material

| | | | |
|-----|---|-----|---|
| GBV | Thread G 3/4 A PN 64 / 316L | PLV | Flange DN 125, PN 40 Form N, DIN 2501 / 316L |
| GBP | Thread G 3/4 A PN 64 / 316L Ra<0,8µm | FMV | Flange DN 150, PN 16 Form C, DIN 2501 / 316L |
| NBV | Thread 3/4" NPT PN 64 / 316L | MMV | Flange DN 150, PN 16 Form D, DIN 2501 / 316L |
| NBP | Thread 3/4" NPT PN 64 / 316L Ra<0,8µm | FVV | Flange DN 150, PN 40 Form C, DIN 2501 / 316L |
| GAV | Thread G 1 A PN 64 / 316L | OVV | Flange DN 150, PN 40 Form F, DIN 2501 / 316L |
| GAP | Thread G 1 A PN 64 / 316L Ra<0,8µm | PVV | Flange DN 150, PN 40 Form N, DIN 2501 / 316L |
| NAV | Thread 1" NPT PN 64 / 316L | FQV | Flange DN 200, PN 16 Form C, DIN 2501 / 316L |
| NAP | Thread 1" NPT PN 64 / 316L Ra<0,8µm | F5V | Flange DN 250, PN 10 Form C, DIN 2501 / 316L |
| GCV | Thread G 1 1/2 A PN 64 / 316L | UCV | Flange DN 40, PN 40 V13, DIN 2501 / 316L |
| NCV | Thread 1 1/2" NPT PN 64 / 316L | FEV | Flange DN 50, PN 40 Form C, DIN 2501 / 316L |
| TAP | Varivent N50-40 / 316L Ra<0,8µm ZB3052 | RCP | Fitting DN 25, PN 40, DIN 11851 / 316L Ra<0,8µm |
| TNP | Varivent N25-100 / 316L Ra<0,8µm ZB3052 | REP | Fitting DN 32, PN 40, DIN 11851 / 316L Ra<0,8µm |
| CCP | Tri-Clamp 1" PN 16 / 316L Ra<0,8µm | RAP | Fitting DN 40, PN 40, DIN 11851 / 316L Ra<0,8µm |
| CBP | Tri-Clamp 1 1/2" PN 16 / 316L Ra<0,8µm | RFP | Fitting DN 40, PN 40, DIN 11864-1A / 316L Ra<0,8µm ZB3052 |
| CAP | Tri-Clamp 2" PN 16 / 316L Ra<0,8µm | RBP | Fitting DN 50, PN 25, DIN 11851 / 316L Ra<0,8µm |
| CDP | Tri-Clamp 2 1/2" PN 10 / 316L Ra<0,8µm | RDP | Fitting DN 50, PN 25, DIN 11864-1A / 316L Ra<0,8µm ZB3052 |
| CEP | Tri-Clamp 3" PN 10 / 316L Ra<0,8µm | | |

Dimensional drawing (Dimensions in mm (inch))

LFV330

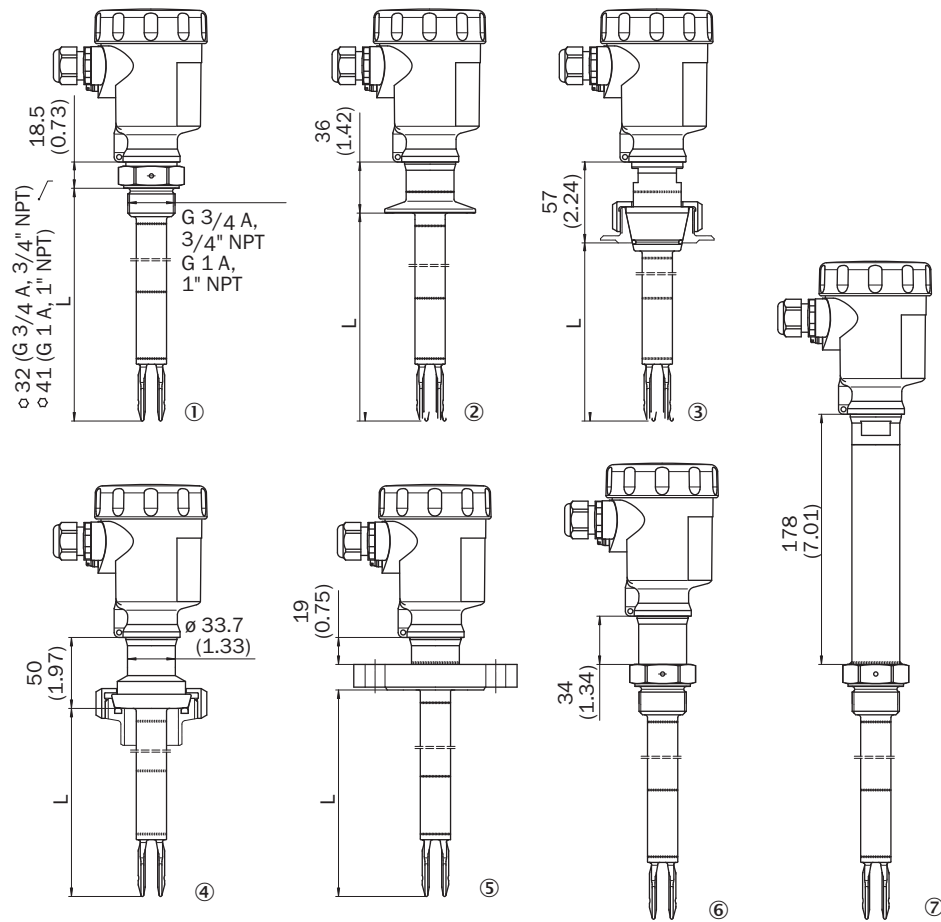

- ① Thread
- ② Tri-Clamp
- ③ DN 25 cone
- ④ Bolting D 40
- ⑤ Flange
- ⑥ Gas-tight leadthrough
- ⑦ Temperature adapter

Marking on the welded flange

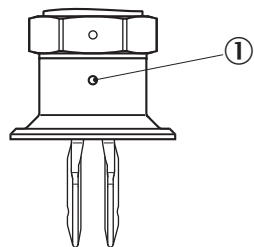

- ① Marking

Connection diagram

Relay - electronic module



- ① Signal lamp (LED)
- ② DIL switch for mode adjustment
- ③ DIL-switch for sensitivity adjustment

Relay connection diagram (single chamber housing)



- ① Relay output
- ② Relay output
- ③ Supply voltage

Instruction for installation

Inflowing medium



Characteristic curve



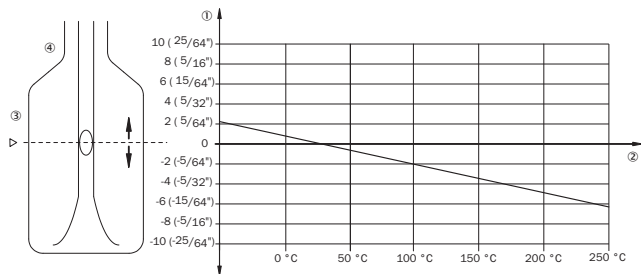

Influence of the process temperature on the switching point



- ① Shifting of the switching point in mm (in)
- ② Process temperature in °C (°F)
- ③ Switching point at reference conditions (notch)
- ④ Tuning fork

Recommended accessories

Other models and accessories → www.sick.com/LFV300

| | Brief description | Type | Part no. |
|---|---|--------------------|----------|
| Electronic modules | | | |
|  | Double relay (DPDT): 20 V DC ... 72 V DC / 20 ... 250 V AC | ECD-RE-LFVREL-0001 | 6038671 |
| Flanges | | | |
|  | Welded flange/welded connector, DIN11851-1, DN25 / PN40, Stainless steel 1.4404 | BEF-FL-851D25-LFV2 | 5321527 |
|  | Welded flange/welded connector, process connection G 1, Stainless steel 1.4404 | BEF-FL-GEWG10-LFV2 | 4054605 |
|  | Welded flange/welded connector, G 3/4 process connection, Stainless steel 1.4404 | BEF-FL-GEWG34-LFV2 | 4054604 |
|  | Welded flange/welded connector, process connection Tri-Clamp 1", Stainless steel 1.4404 | BEF-FL-TCLI10-LFV2 | 5321678 |
| | Welded flange/welded connector, process connection Tri-Clamp 2", Stainless steel 1.4404 | BEF-FL-TCLI20-LFV2 | 5321679 |
| Mounting brackets and plates | | | |
| | BEF-MU-316G10-ALFV | BEF-MU-316G10-ALFV | 5322463 |

SICK AT A GLANCE

SICK is one of the leading manufacturers of intelligent sensors and sensor solutions for industrial applications. A unique range of products and services creates the perfect basis for controlling processes securely and efficiently, protecting individuals from accidents and preventing damage to the environment.

We have extensive experience in a wide range of industries and understand their processes and requirements. With intelligent sensors, we can deliver exactly what our customers need. In application centers in Europe, Asia and North America, system solutions are tested and optimized in accordance with customer specifications. All this makes us a reliable supplier and development partner.

Comprehensive services complete our offering: SICK LifeTime Services provide support throughout the machine life cycle and ensure safety and productivity.

For us, that is “Sensor Intelligence.”

WORLDWIDE PRESENCE:

Contacts and other locations –www.sick.com