

Operating Guide

VRB2, VRB 3, VRG 2, VRG 3 DN 15-50

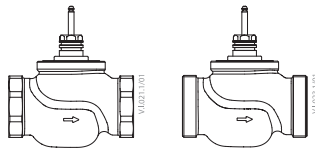

MAINTENANCE
FREE



VRB 2, VRG 2 (DN 15-50)

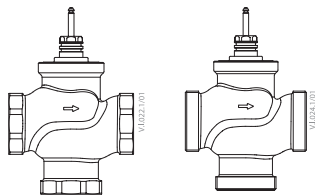

VRB 3, VRG 3 (DN 15-50)

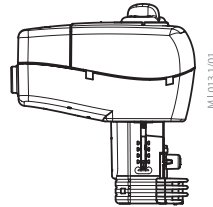

AMV(E) 335, 435

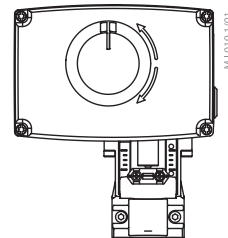

AMV(E) 25 (SU/SD), 35 +
adapter **065Z0311**

AMV(E) 438 SU

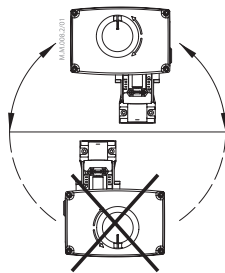
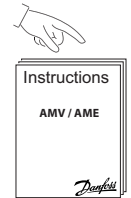

IP 54
AMV(E) 438 SU
AMV(E) 25 (SU/SD), 35

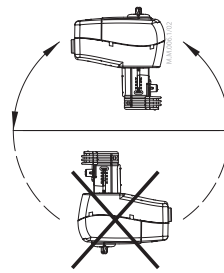

IP 54
AMV(E) 335/435

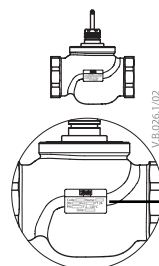
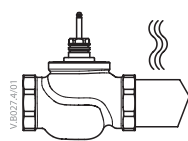

MADE IN SLOVENIA	
Code: <input type="text"/>	Name: <input type="text"/>
DN: <input type="text"/>	Kvs: <input type="text"/> PT 24
PN: <input type="text"/>	T: 2...130°C
Date: <input type="text"/>	

VRB 2, VRB 3, VRG 2, VRG 3



 MADE IN SLOVENIA	
Code: _____	Name: _____
DN: _____	Kvs: _____ PT 24
PN: _____	T: 2...130°C
Date: _____	

VRB 2, VRB 3
CuSn5ZnPb (Rg5)

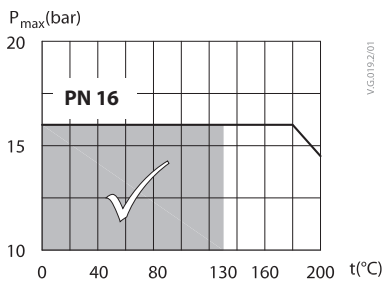

VRG 2, VRG 3
EN-GJL-250 (GG-25)

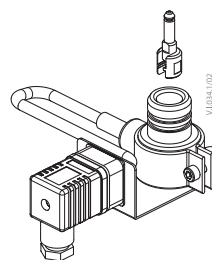
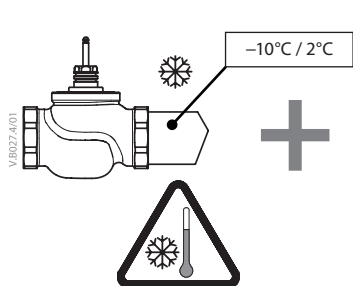
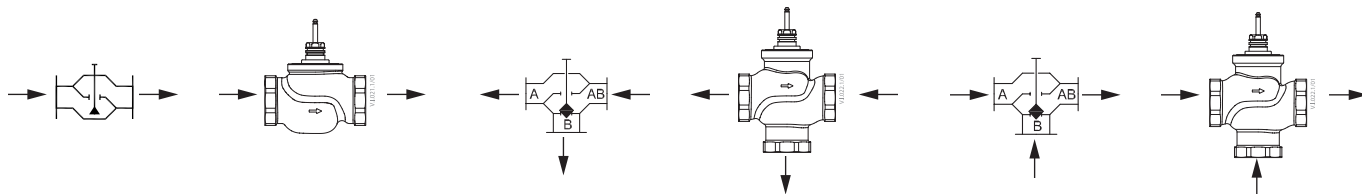
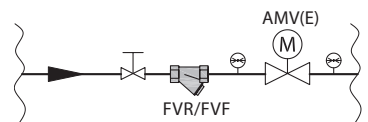
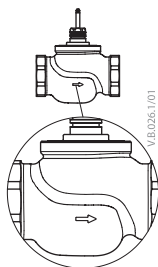
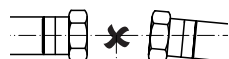
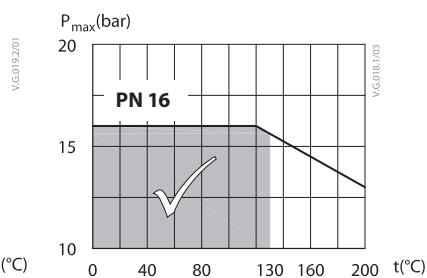

Stem heater **065Z0315**

DN	Actuators
15-50	AMV(E) 335
	AMV(E) 435
	AMV(E) 438 SU
	AMV(E) 25 (SU/SD) + adapter
	AMV(E) 35 + adapter

VRB 2, VRB 3, VRG 2, VRG 3

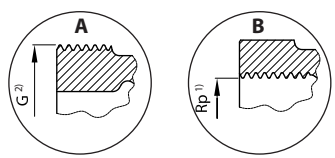
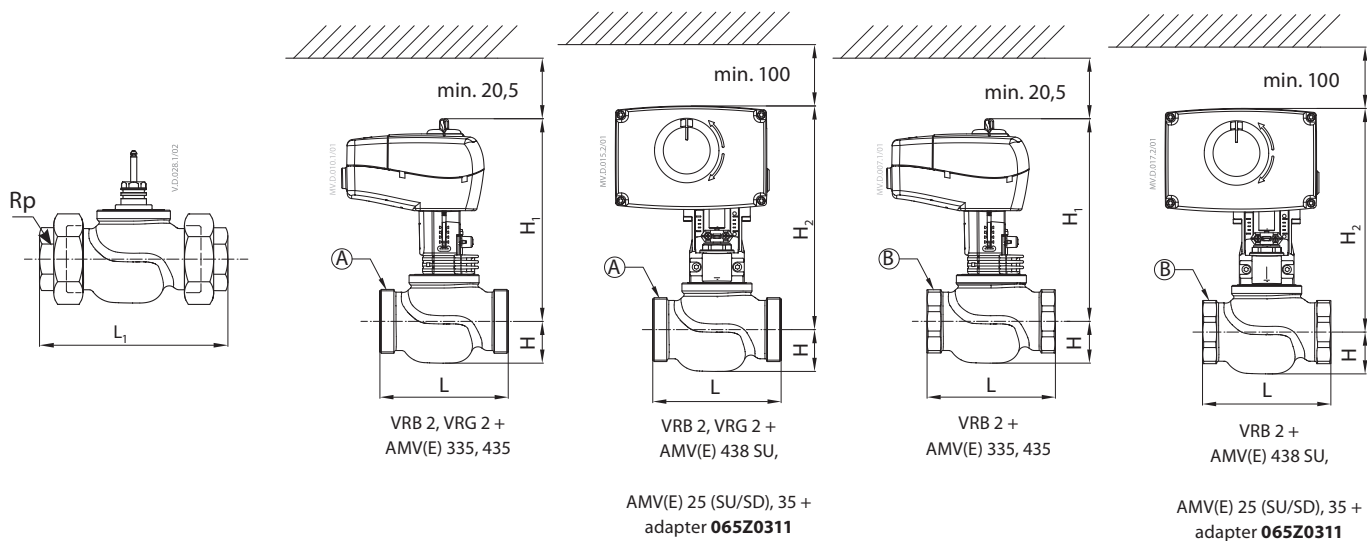

Type	DN	Rp ¹⁾	G ²⁾	mm				
				L	L ₁	H	H ₁	H ₂
VRB 2 VRG 2	15	½	1	80	128	25	191	216
	20	¾	1¼	80	128	29	194	218
	25	1	1½	95	151	29	197	222
	32	1¼	2	112	178	35	202	226
	40	1½	2¼	132	201	43	213	237
	50	2	2¾	160	234	47	217	242

¹⁾ Rp EN 10226-1
²⁾ G DIN ISO 228/01

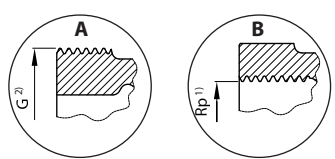
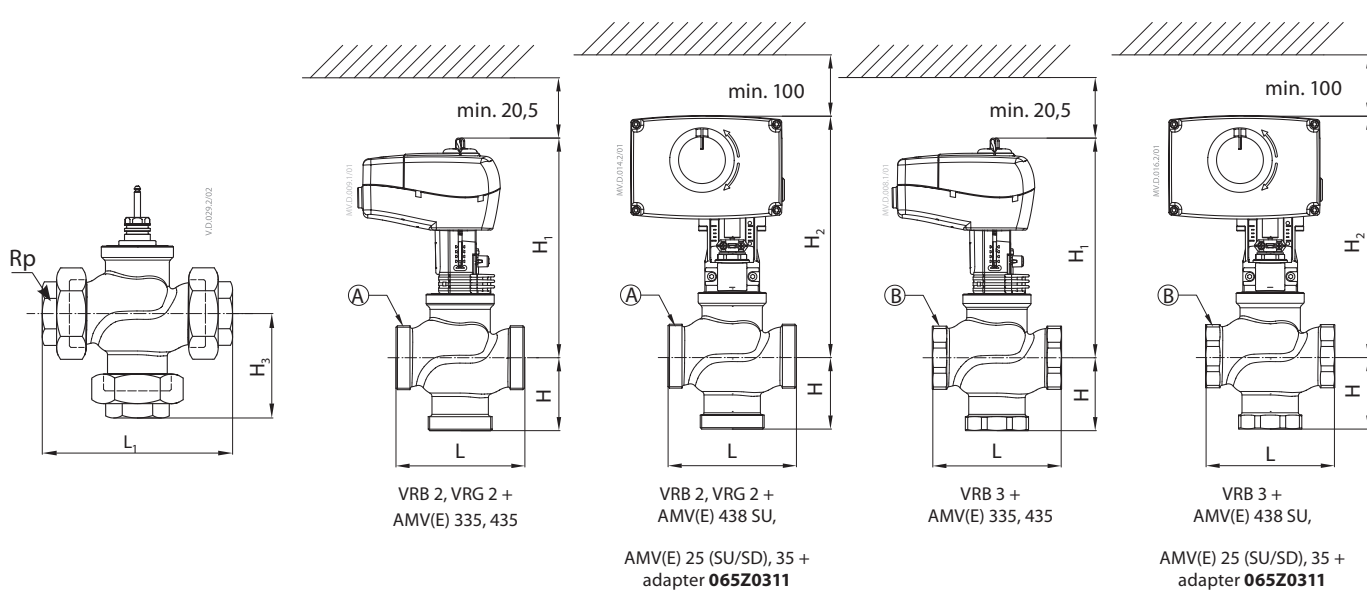

Type	DN	Rp ¹⁾	G ²⁾	mm					
				L	L ₁	H	H ₁	H ₂	H ₃
VRB 3 VRG 3	15	½	1	80	128	40	191	216	64
	20	¾	1¼	80	128	45	194	218	69
	25	1	1½	95	151	50	197	222	78
	32	1¼	2	112	178	58	202	226	91
	40	1½	2¼	132	201	75	230	255	110
	50	2	2¾	160	234	83	243	268	120

¹⁾ Rp EN 10226-1
²⁾ G DIN ISO 228/01



VRB 2, VRB 3, VRG 2, VRG 3
