

	EAN	⊙ l x w x h mm	W	V~	Hz	lm	lm/W
TRUSYS UNIV P 50W 840 VN CL PS	4099854496745	1504 x 68 x 26	50*	220-240	0/50/60	9000*	180*
TRUSYS UNIV P 50W 840 N CL PS	4099854496684	1504 x 68 x 26	50*	220-240	0/50/60	9000*	180*
TRUSYS UNIV P 50W 840 W CL PS	4099854496622	1504 x 68 x 26	50*	220-240	0/50/60	9000*	180*
TRUSYS UNIV P 50W 840 VW OP PS	4099854496561	1504 x 68 x 38	50*	220-240	0/50/60	8150*	180*
TRUSYS UNIV P 73W 840 VN CL PS	4099854311581	1504 x 68 x 26	73**	220-240	0/50/60	12400**	170**
TRUSYS UNIV P 73W 840 N CL PS	4099854311604	1504 x 68 x 26	73**	220-240	0/50/60	12400**	170**
TRUSYS UNIV P 73W 840 W CL PS	4099854311628	1504 x 68 x 26	73**	220-240	0/50/60	12400**	170**
TRUSYS UNIV P 73W 840 VW OP PS	4099854496806	1504 x 68 x 38	73**	220-240	0/50/60	11900**	163**
TRUSYS UNIV P 50W 840 VN CL PS DALI	4099854496882	1504 x 68 x 26	50	220-240	0/50/60	9000	180
TRUSYS UNIV P 50W 840 N CL PS DALI	4099854496868	1504 x 68 x 26	50	220-240	0/50/60	9000	180
TRUSYS UNIV P 50W 840 W CL PS DALI	4099854496844	1504 x 68 x 26	50	220-240	0/50/60	9000	180
TRUSYS UNIV P 50W 840 VW OP PS DALI	4099854496820	1504 x 68 x 38	50	220-240	0/50/60	8150	163
TRUSYS UNIV P 75W 840 VN CL PS DALI	4099854311642	1504 x 68 x 26	75	220-240	0/50/60	12750	170
TRUSYS UNIV P 75W 840 N CL PS DALI	4099854311697	1504 x 68 x 26	75	220-240	0/50/60	12750	170
TRUSYS UNIV P 75W 840 W CL PS DALI	4099854311710	1504 x 68 x 26	75	220-240	0/50/60	12750	170
TRUSYS UNIV P 75W 840 VW OP PS DALI	4099854496929	1504 x 68 x 38	75	220-240	0/50/60	12220	163

	EAN	K	IP	IK	∇	R _a	°(°C)	PF	☾	👤
TRUSYS UNIV P 50W 840 VN CL PS	4099854496745	4000	20	02	30°	≥80	-20 ... +40	≥0.95	–	1.7 kg
TRUSYS UNIV P 50W 840 N CL PS	4099854496684	4000	20	02	60°	≥80	-20 ... +40	≥0.95	–	1.7 kg
TRUSYS UNIV P 50W 840 W CL PS	4099854496622	4000	20	02	90°	≥80	-20 ... +40	≥0.95	–	1.7 kg
TRUSYS UNIV P 50W 840 VW OP PS	4099854496561	4000	20	02	120°	≥80	-20 ... +40	≥0.95	–	1.6 kg
TRUSYS UNIV P 73W 840 VN CL PS	4099854311581	4000	20	02	30°	≥80	-20 ... +40	≥0.95	–	1.7 kg
TRUSYS UNIV P 73W 840 N CL PS	4099854311604	4000	20	02	60°	≥80	-20 ... +40	≥0.95	–	1.7 kg
TRUSYS UNIV P 73W 840 W CL PS	4099854311628	4000	20	02	90°	≥80	-20 ... +40	≥0.95	–	1.7 kg
TRUSYS UNIV P 73W 840 VW OP PS	4099854496806	4000	20	02	120°	≥80	-20 ... +40	≥0.95	–	1.6 kg
TRUSYS UNIV P 50W 840 VN CL PS DALI	4099854496882	4000	20	02	30°	≥80	-20 ... +40	≥0.95	DALI2	1.8 kg
TRUSYS UNIV P 50W 840 N CL PS DALI	4099854496868	4000	20	02	60°	≥80	-20 ... +40	≥0.95	DALI2	1.8 kg
TRUSYS UNIV P 50W 840 W CL PS DALI	4099854496844	4000	20	02	90°	≥80	-20 ... +40	≥0.95	DALI2	1.8 kg
TRUSYS UNIV P 50W 840 VW OP PS DALI	4099854496820	4000	20	02	120°	≥80	-20 ... +40	≥0.95	DALI2	1.7 kg
TRUSYS UNIV P 75W 840 VN CL PS DALI	4099854311642	4000	20	02	30°	≥80	-20 ... +40	≥0.95	DALI2	1.8 kg
TRUSYS UNIV P 75W 840 N CL PS DALI	4099854311697	4000	20	02	60°	≥80	-20 ... +40	≥0.95	DALI2	1.8 kg
TRUSYS UNIV P 75W 840 W CL PS DALI	4099854311710	4000	20	02	90°	≥80	-20 ... +40	≥0.95	DALI2	1.8 kg
TRUSYS UNIV P 75W 840 VW OP PS DALI	4099854496929	4000	20	02	120°	≥80	-20 ... +40	≥0.95	DALI2	1.7 kg
TRUSYS UNIV FEED IN 5P	4099854317347	–	–	–	–	–	–	–	–	0.03 kg
TRUSYS UNIV FEED IN 7P	4099854317361	–	–	–	–	–	–	–	–	0.04 kg
TRUSYS UNIV BLIND COVER	4099854317385	–	20	02	–	–	–	–	–	0.6 kg
TRUSYS UNIV 1500 5P WIRE	4099854317408	–	–	–	–	–	–	–	–	0.2 kg
TRUSYS UNIV 1500 7P WIRE	4099854317583	–	–	–	–	–	–	–	–	0.3 kg
TRUSYS UNIV 3000 5P WIRE	4099854317606	–	–	–	–	–	–	–	–	0.4 kg
TRUSYS UNIV 3000 7P WIRE	4099854317620	–	–	–	–	–	–	–	–	0.5 kg

*	W	50	40	30	20
50W CL	lm	9000	7400	5550	3700
	lm/W	180	185	185	185
50W OP	lm	8150	6660	5040	3300
	lm/W	163	165	168	165

**	W	73	66	57	49	41
73W CL	lm	12400	11420	10030	8720	7380
	lm/W	170	173	176	178	180
73W OP	lm	11900	10890	9575	8230	6890
	lm/W	163	165	168	168	168



1

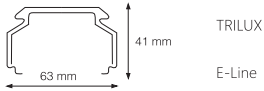

2

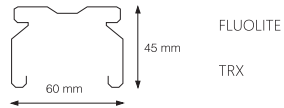

3

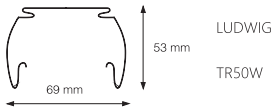

4

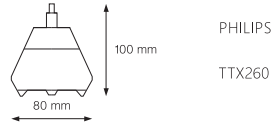

5

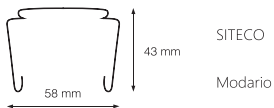

6

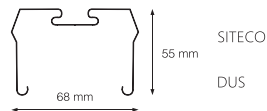

7

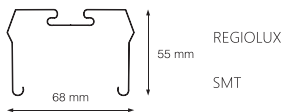

8

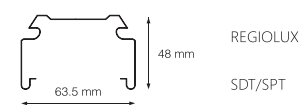

9

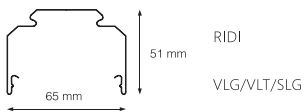

10

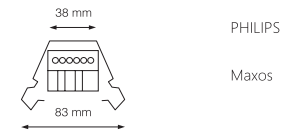

11

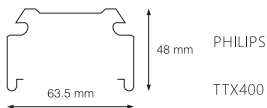

12

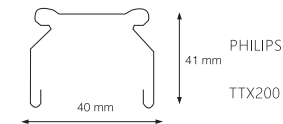

13 ***

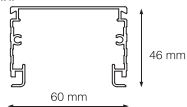

VEKO

PNR

14 ***

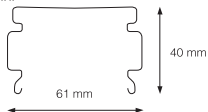

ZUMTOBEL

ZX1

15 ***

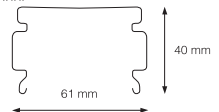

ZUMTOBEL

ZX2

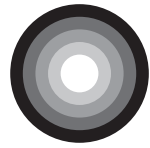

13	VEKO	PNR
14	ZUMTOBEL	ZX1
15	ZUMTOBEL	ZX2

TruSys UNIVERSAL 50W ON/OFF*

W	LM	1	2	3
20W	3700/3300	—	—	—
30W	5550/5040	—	ON	—
40W	7400/6660	—	—	ON
50W	9000/8150	—	ON	ON

TruSys UNIVERSAL 73W ON/OFF**

W	LM	1	2	3	4
41W	7380/6890	—	—	—	ON
49W	8720/8230	—	—	ON	—
57W	10030/9575	—	ON	—	—
66W	11420/10890	ON	—	—	—
73W	12400/11900	—	—	—	—

1

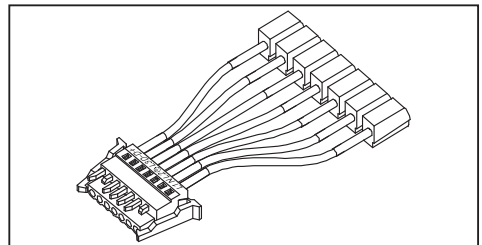



TRUSYS UNIV FEED IN 5P

EAN 4099854317347

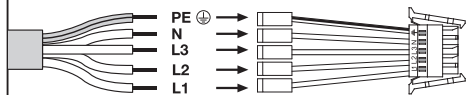

TRUSYS UNIV FEED IN 7P

EAN 4099854317361

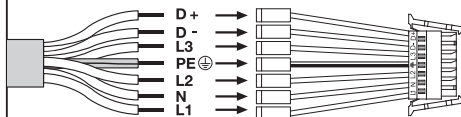

2

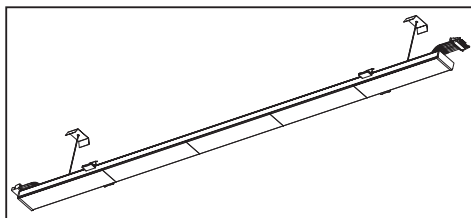
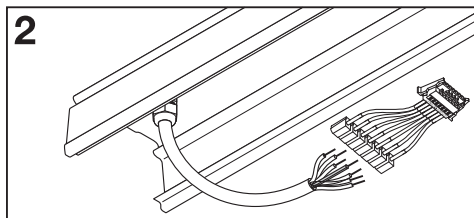

3

TRUSYS UNIV SAFETY ROPE
EAN 4099854317644

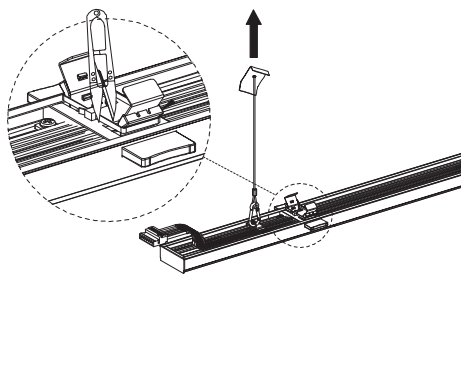

4

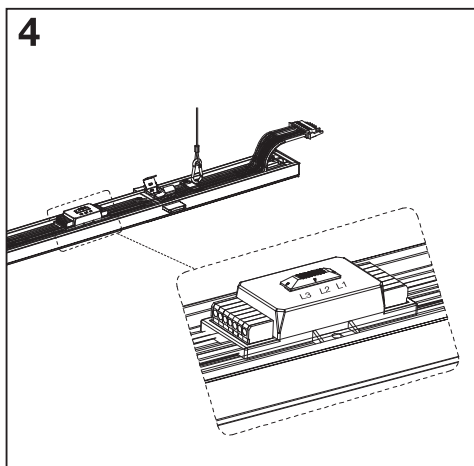

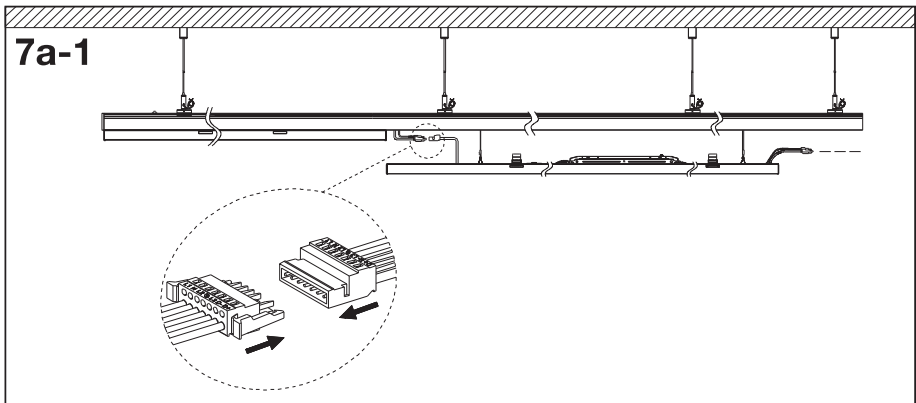
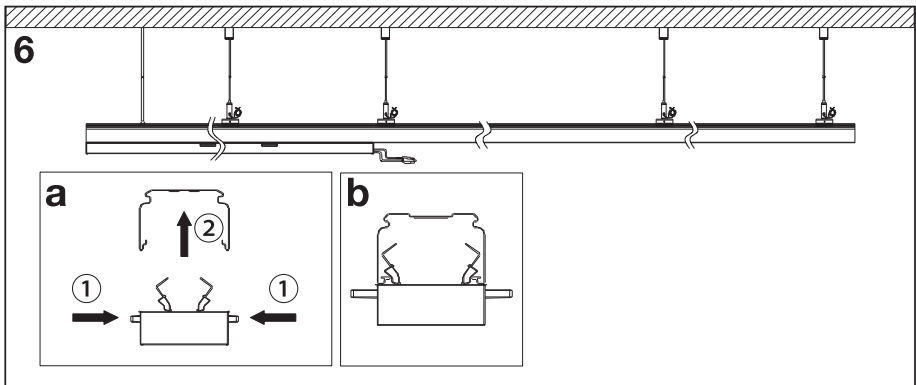
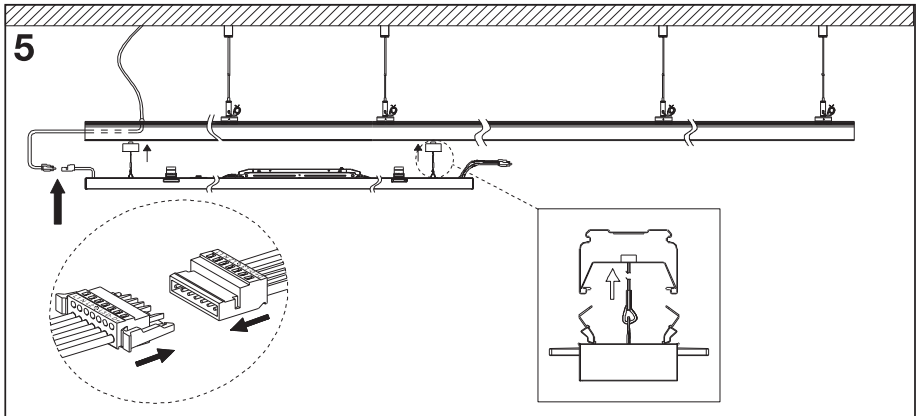

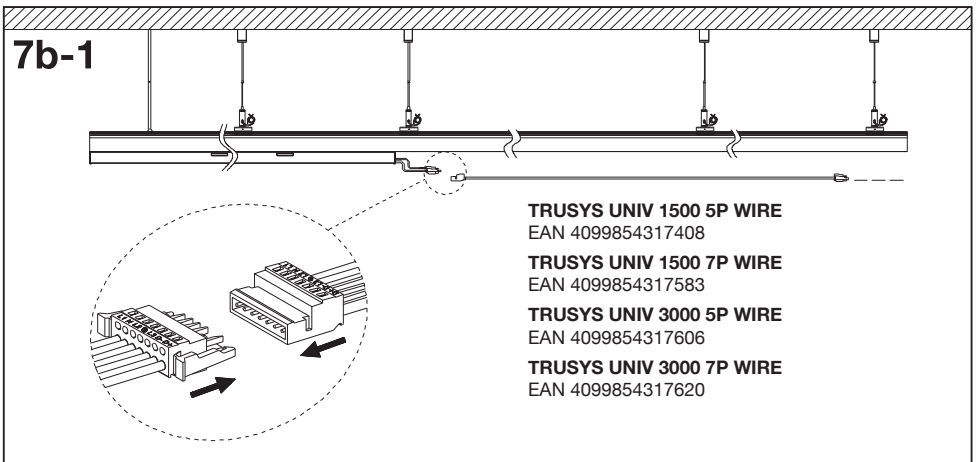
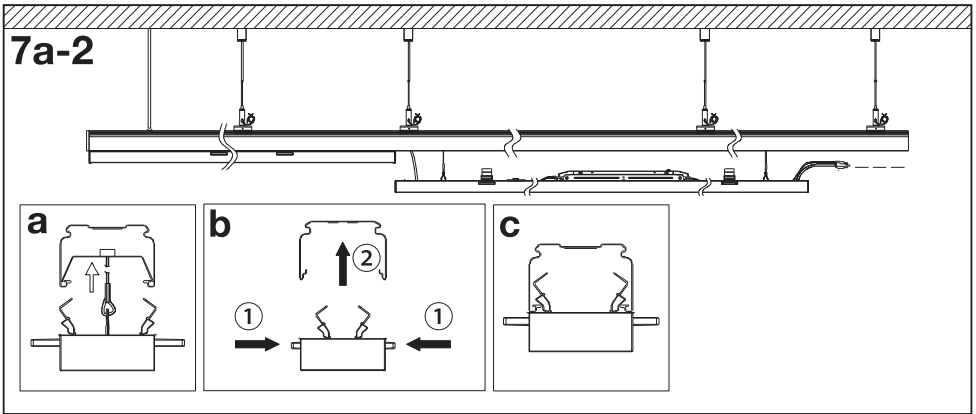



7b-2

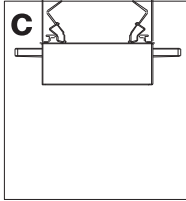
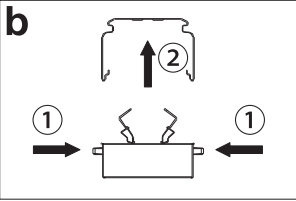
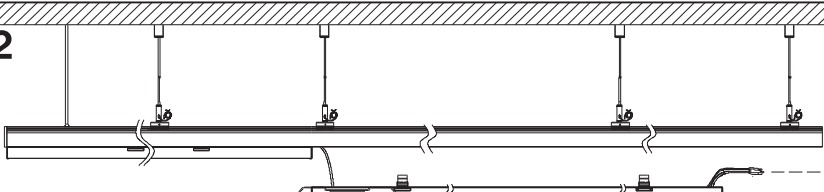

TRUSYS UNIV BLIND COVER
EAN 4099854317385

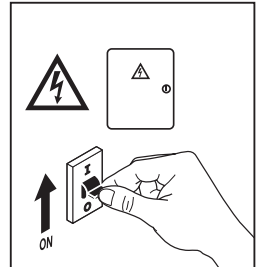
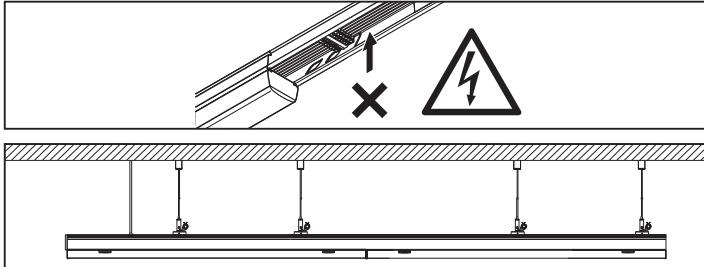

	1x TRUSYS UNIV			2x TRUSYS UNIV			...	nx TRUSYS UNIV		
	C10 A	B16 A	C16 A	Inrush current	Inrush Charge Time	DALI DIM				
TRUSYS UNIV 50W ON/OFF	13	14	21	22.6 A	247 µs	⚠				
TRUSYS UNIV 73W ON/OFF	8	8	14	25.5 A	302 µs	⚠				
TRUSYS UNIV 50W DALI	12	12	19	20.75 A	266 µs	⚠				
TRUSYS UNIV 75W DALI	7	9	12	51.4 A	156 µs	⚠				

(D) 1) Kompatible Trunking-Liste. (GB) 1) Compatible trunking list. (F) 1) Liste de jonctions compatibles.
 (I) 1) Elenco trunking compatibile. (E) 1) Lista de enlaces troncales compatibles. (P) 1) Lista de calhas compatíveis. (GR) 1) Συμβατή λίστα ζεύξεων. (NL) 1) Compatibele trunkinglijst. (S) 1) Kompatibel trunkinglista. (FIN) 1) Yhteensopivan jakelukiskojen luettelo. (N) 1) Kompatibel trunkeringsliste.
 (DK) 1) Lister over kompatible trunks. (CZ) 1) Seznam kompatibilních hlavních stanic. (RU) 1) Список совместимых желобов. (H) 1) Kompatibilis trunking lista. (PL) 1) Kompatybilna lista trunkingowa.
 (SK) 1) Zoznam kompatibilných kanálov. (SI) 1) Seznam združljivih magistralnih omrežij (ang. trunking).
 (TR) 1) Uyumlu kablo kanalı listesi. (HR) 1) Popis kompatibilnih kanala. (RO) 1) Listă grupare trunking compatibilă. (BG) 1) Списък на съвместими канали. (EST) 1) Ühilduv magistraalloend. (LT) 1) Suderinamų kabelių kanalų sąrašas. (LV) 1) Saderīgs kanālu saraksts. (SB) 1) Kompatibilna lista kanala. (UA) 1) Список сумісних транкінгів. (CZ) 1) Yйлесімді транкінгтік тізім.

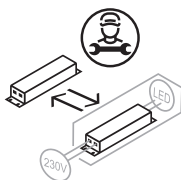

PAP
Raccolta Carta
 Verifica le disposizioni
 del tuo comune.



LEDVANCE SASU
 CQM, 5 rue d'Altorf
 67120 Molsheim France
www.ledvance.com



FR
Cet appareil et ses accessoires se recyclent
 À DÉPOSER EN MAGASIN
 À DÉPOSER EN DÉCHÈTERIE
 OU

Points de collecte sur www.quefairedemesdechets.fr

C10449058
 G11255784

01.10.25

(GB) LEDVANCE Ltd, Sterling House,
 810 Mandarin Court, Warrington,
 Cheshire, WA1 1GG, United Kingdom