



Installation Guide







SubstiTUBE®
T8
T5

LEDVANCE is licensee of product trademark
OSRAM for lamps products in general lighting.



Portfolio

Product line	SubstiTUBE® T8 EM	SubstiTUBE® T8 Universal	SubstiTUBE® T8 HF
T8			
Compatibility	Electromagnetic ballast (EM/CCG) and line voltage (220-240V)	Electromagnetic ballast (EM/CCG) High frequency / electronic control gear (HF/ECG) and line voltage (220-240V)	High frequency / electronic control gear (HF/ECG). Operation with ECG in luminaire only!
Product line	SubstiTUBE® T5 HF		SubstiTUBE® T5 AC
T5			
Compatibility	High frequency / electronic control gear (HF/ECG). Operation with ECG in luminaire only!		AC Mains (220-240V)

Agenda

page

1. Installation options	4
1.1 Notes on the Tc temperature of SubstiTUBE® lamps	
1.2 Retrofitting a CCG luminaire accord. to EN 62776	
1.3 Conversion of an ECG or CCG luminaire	
1.4 Retrofitting an ECG luminaire accord. to EN 62776	
1.5 Test to check the control gear (CCG oder ECG)	
2. SubstiTUBE® T8 EM	7
2.1 Retrofitting in a CCG luminaire	
2.1.1 Luminaires with compensating capacitor	
2.1.2 Duo circuit lamp luminaire	
2.1.3 Tandem operation	
2.2 Conversion / Direct Wiring	
2.2.1 Direct line voltage connection	
2.2.2 Sample installation direct wiring	
3. SubstiTUBE® T8 and T5 HF	13
3.1 Retrofitting in an ECG luminaire	
3.2 Multi circuit lamp luminaire	
3.3 Compatibility list	
4. SubstiTUBE® T8 Universal (UN)	16
4.1 Retrofitting in a CCG luminaire	
4.1.1 Luminaires with compensating capacitor	
4.1.2 Duo circuit lamp luminaire	
4.2 Retrofitting in an ECG luminaire	
4.2.1 Multi circuit lamp luminaire	
4.2.2 Compatibility list	
4.3 Conversion / Direct Wiring	
5. SubstiTUBE® T5 AC Mains (220-240V)	17
5.1 Conversion / Direct Wiring	
5.2 Installation instruction	

1. Installation options

1.1 Notes on the Tc temperature of SubstiTUBE® lamps

Due to LED lamps react more sensitively to increased ambient temperatures than conventional fluorescent lamps, we recommend that you pay attention to the ambient and housing temperature (Ta and Tc temperature) of the SubstiTUBE® in the respective application, especially in narrow, closed or multi-lamp luminaires. The Tc max temperature is the highest permissible temperature that may occur on the outer surface of the lamp.

In multi circuit lamp luminaires, the Tc temperature must be measured at each lamp in the luminaire. The use of a temperature measuring device and a flexible thermal sensor (e.g. "Type K") is recommended for measurement.

The measurement takes place at the Tc point with the lamp switched on, the maximum Tc temperature is set with a burning time of 1h to 2h. The measurement must take place under real ambient conditions. In the case of luminaires with covers, the luminaire must be closed during the measurement. Unfavorable environmental conditions such as seasonal temperature fluctuations (hot summer day) must also be taken into account. For this, it is advisable to plan an extra temperature buffer if necessary.

Example:

Tc measurement during installation => measured Tc temperature = 60 ° C. In summer the room temperature can be e.g. 10 ° C higher => Tc temperature could rise to approx. 70 ° C.

Please ensure that the maximum permissible Ta and Tc temperatures specified in the respective data sheet are not exceeded. Exceeding these temperatures can lead to permanent damage to the SubstiTUBE®. Further information can be found in the data sheet.

Note: SubstiTUBE® UN has two Tc points for HF (EVG) operation and for EM (KVG) / mains voltage operation

1. Installation options

1.2 Retrofitting a CCG luminaire accord. to EN 62776

Replacing fluorescent T8-tube and installed starter by **SubstiTUBE®** T8 EM and **SubstiTUBE®** Start. Alternatively, the SubstiTUBE® T8 Universal and SubstiTUBE® UN-Start can also be used for CCG luminaires.

1.3 Conversion of an ECG or CCG luminaire

Rewiring of the luminaire is necessary for replacing fluorescent tubes with **SubstiTUBE®** T8 EM in ECG luminaires. Alternatively, rewiring is also possible for use of **SubstiTUBE®** T8 EM in CCG luminaires or the SubstiTUBE® T8 UN. Installation must be executed by a qualified electrician and all security precautions described herein must be followed. Please refer to chapter 2.2.2 “Sample installation direct wiring” for more details.

1.4 Retrofitting an ECG luminaire accord. to EN 62776

Replacing conventional fluorescent T8 tube by **SubstiTUBE®** T8 HF/UN. Before retrofitting, check ECG compatibility list at www.ledvance.com/ecg-compatibility, as **SubstiTUBE®** T8 HF/UN has to be compatible with installed ECG.

Overview of possible installations

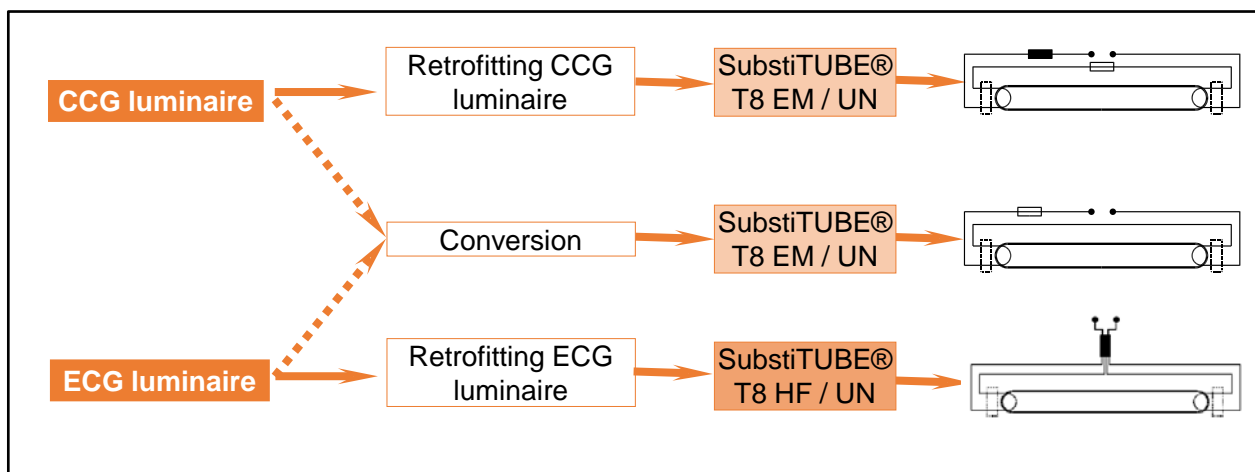

1. Installation options

1.5 Test to check the control gear (CCG oder ECG)

You are not sure which lamp technology (EM or HF) to choose for your application? The following two simple tests can help you to quickly find the suitable product.



Starter-Test

Check whether the luminaire in which the new lamp should be used has a starter. If it has, you need a **SubstiTUBE®** T8 EM or UN for operation on CCG.

If it doesn't have a starter, use the ECG-compatible HF version

Camera test

If a functioning T8 fluorescent lamp is still installed in the luminaire, observe it through a digital camera (e.g. on your smartphone or tablet). If the light is flickering, you need a **SubstiTUBE®** T8 EM or UN for operation on CCG. Otherwise, use the ECG-compatible HF version.

2. SubstiTUBE® T8 EM

2.1 Retrofitting in a CCG luminaire

Simple luminaire upgrade with a LED Tube. The fluorescent T8 lamp has to be replaced with a SubstiTUBE® T8 EM and the starter replaced with SubstiTUBE® Start. The built-in CCG can remain in the luminaires and existing certifications remain valid. CCG loss is usually reduced to about 1W.

Note: If the starter has not been exchanged by SubstiTUBE® Start the lamp will start blinking. Please switch off immediately and change the starter, because the SubstiTUBE® T8 EM can be damaged. SubstiTUBE® T8 EM can be used in luminaires with exchangeable starters only.

Retrofitting for common lamp holders

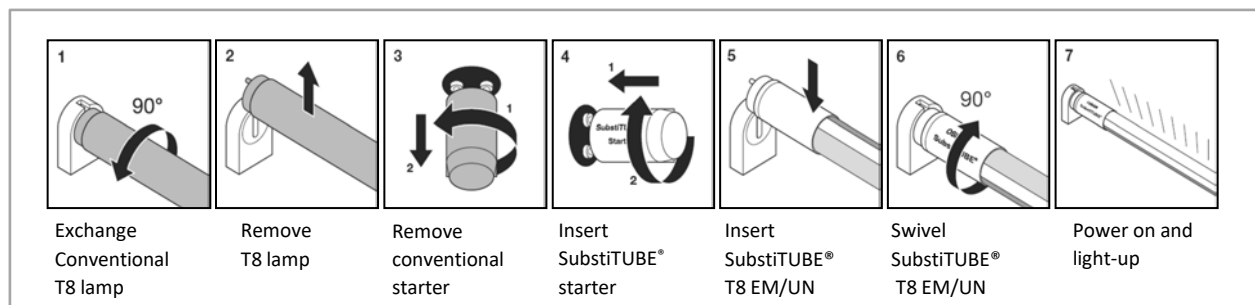

Note: SubstiTUBE® Start is necessary for operation

As an alternative to the SubstiTUBE® EM, the SubstiTUBE® UN can also be used.

2. SubstiTUBE® T8 EM

2.1.1 Luminaires with compensation capacitors

SubstiTUBE® T8 EM can be used in luminaires with integrated compensation capacitors. The maximum possible amount of SubstiTUBE® T8 EM operated on one circuit breaker in compensated luminaires can be found in the respective SubstiTUBE® product data sheet on www.ledvance.com/substitute.

Circuit diagram of a retrofitted CCG luminaire

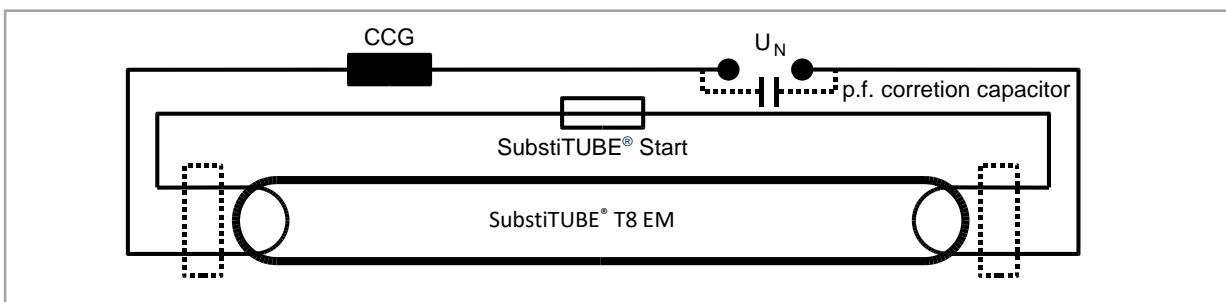

Note:

As an alternative to the SubstiTUBE® EM, the SubstiTUBE® UN can also be used.

2.1.2 Duo circuit lamp luminaires with compensation capacitors

Double lamp luminaires can be refitted in the same way as single lamp luminaires if they show duo circuit wiring according to below scheme.

Usage in tandem circuitry luminaires with serial wired lamps requires rewiring

Circuit diagram of a retrofitted double lamp CCG luminaire

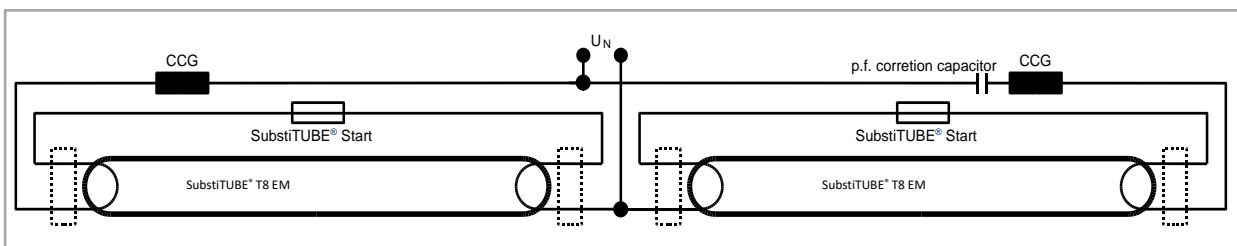

Note:

As an alternative to the SubstiTUBE® EM, the SubstiTUBE® UN can also be used.

2. SubstiTUBE® T8 EM

2.1.3 Tandem operation

SubstiTUBE® EM tubes with a length of 600mm* are suitable for tandem operation, a circuit diagram is shown below.

Circuit diagram of a luminaire in tandem operation

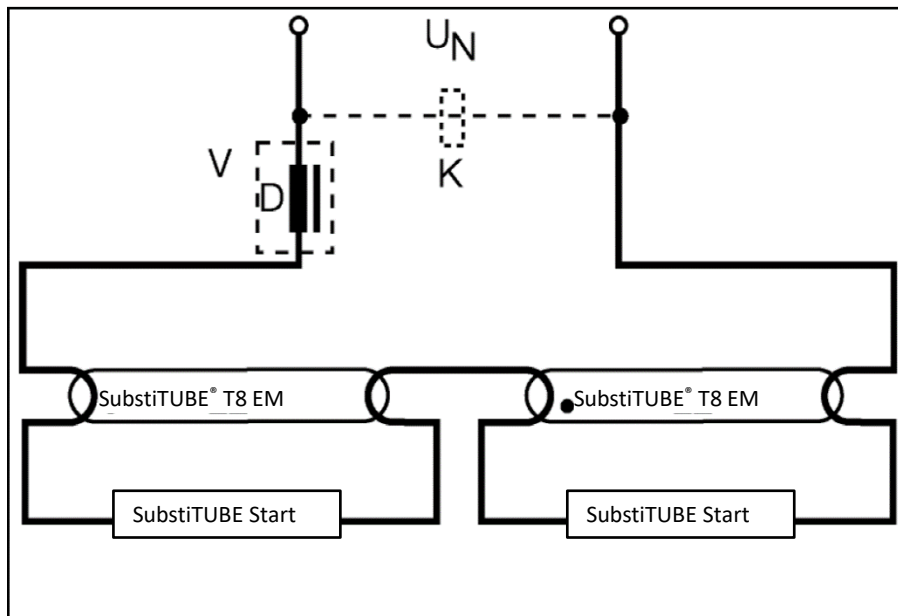

* Except SubstiTUBE® T8 Motion Sensor EM

Note:

The SubstiTUBE® UN lamps are not suitable for tandem operation.

2. SubstiTUBE® T8 EM

2.2 Conversion / Direct Wiring

2.2.1 AC mains operation

SubstiTUBE® T8 EM tubes can be operated on direct mains voltage 220V-240V to eliminate remaining losses on CCG or ECG. Conversion must be done according to instruction 2.2.3 “Sample installation direct wiring” and the circuit diagram below so the SubstiTUBE® T8 EM can be inserted in any direction into the G13 lamp holders.

All wires need to be approved for the existing voltages and protection classes. Usually, solid wires with single isolation can be used for class I, double insulation wires should be used for class II. The maximum wire cross-section for lamp holders and starters is typically 0.5mm². Built-in control gears must be removed after rewiring.

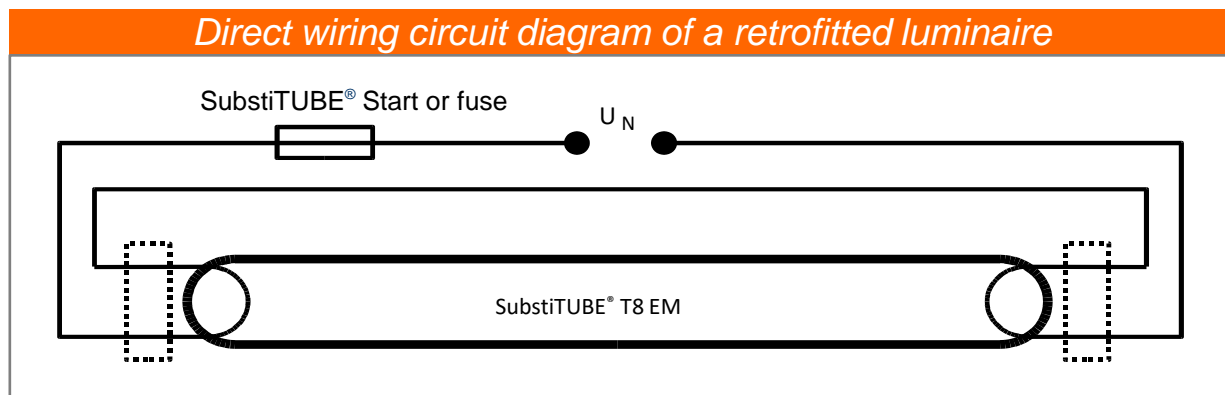

Note:

As an alternative to the SubstiTUBE® EM, the SubstiTUBE® UN can also be used.

2. SubstiTUBE® T8 EM

2.2.2 Installation instructions

Note: Rewiring by qualified electricians only.

1. Make sure that the luminaire is disconnected from the mains
2. Remove the conventional lamp
3. Remove power factor correction capacitor (if installed) to improve power factor
4. Rewire the luminaire as shown in the circuit diagram on the page before

Note: Use SubstiTUBE® Start or a fuse (250V, T2A).

5. Insert SubstiTUBE® T8 EM into lamp holders
6. Make sure, that the rewired luminaire complies to all relevant safety requirements and other applicable regulations, e.g. acc. to DIN VDE 0701-0702 or 2004/108/EC by conducting appropriate tests.
7. Mark rewired luminaire with new name plate

Note: After rewiring only LED tubes can be used in this luminaire. The use of traditional fluorescent tubes is not permitted anymore.

Direct wiring circuit diagram of a retrofitted double lamp luminaire

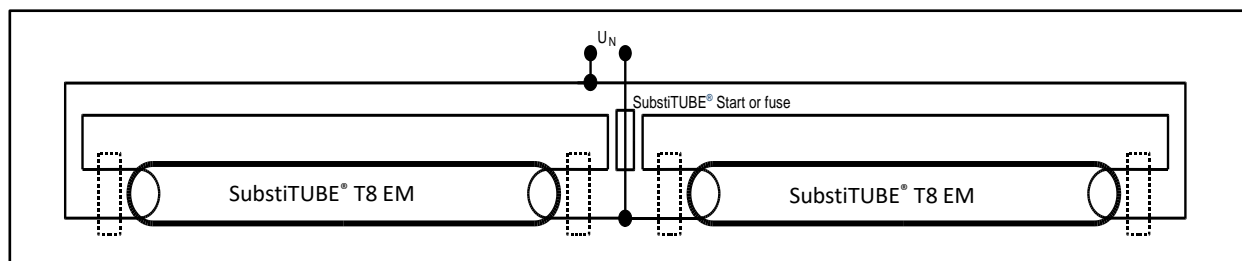

Note:

As an alternative to the SubstiTUBE® EM, the SubstiTUBE® UN can also be used.

2. SubstiTUBE® T8 EM

2.2.3 Sample installation direct wiring

Direct wiring of a luminaire for SubstiTUBE® T8 EM (control gear removed).

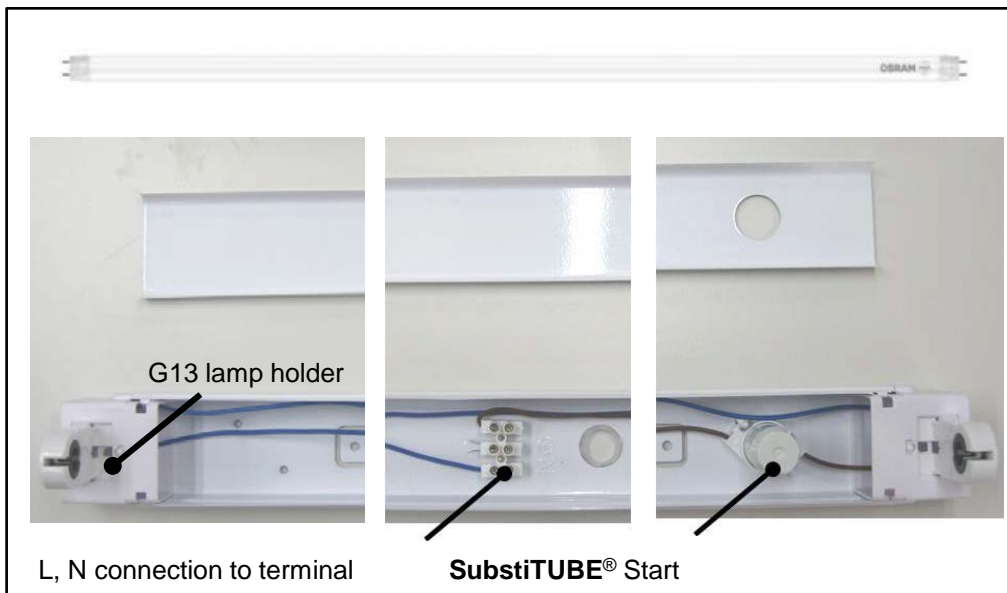

Make sure to modify the wiring completely, otherwise e.g. short circuits could lead to damage.



Example for an integrated holder for SubstiTUBE® EM + Starter



Example for terminal block with integrated fuseholder

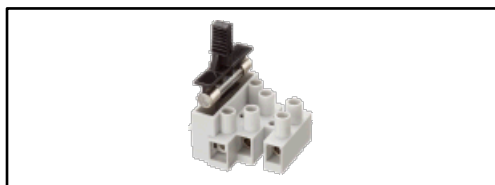

3. SubstiTUBE® T8/T5 HF

3.1 Retrofitting in an ECG luminaire

Replacing the lamp is all that needs to be done to upgrade an existing luminaire with electrical control gear to newest OSRAM® HF-LED-technology. Since only the lamp is replaced, there is no constructive modification necessary to the luminaire. The **SubstiTUBE®** HF/UN tube is compatible with ECGs of various brand manufacturers. For further information regarding the tested ECGs a compatibility list is available on www.ledvance.com/substiTUBE.

Energy consumption on ballast level will not be reduced by retrofitting, compared to a retrofitted CCG luminaire.

This is part of the new international safety norm IEC 62776

Circuit diagram of a retrofitted ECG luminaire

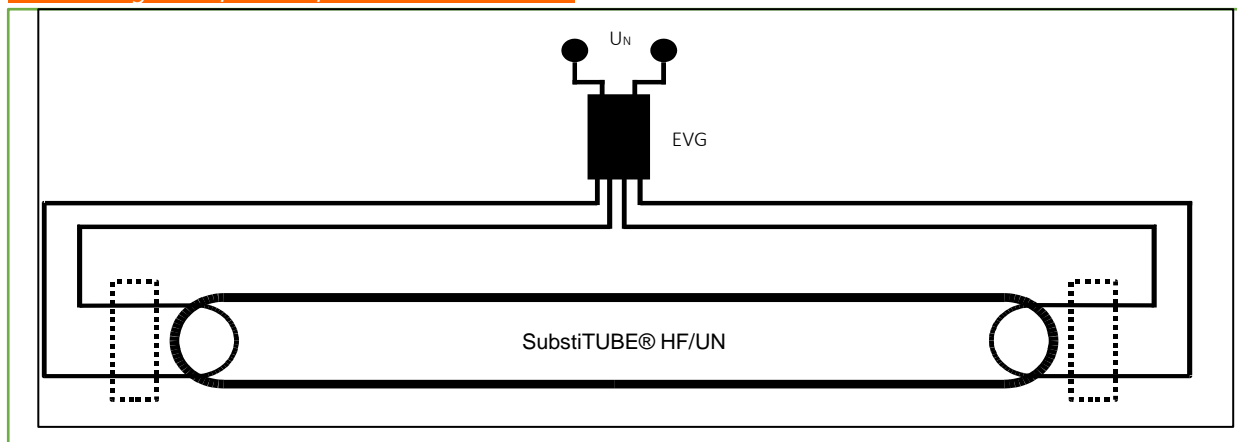

Retrofitting for common lamp holders

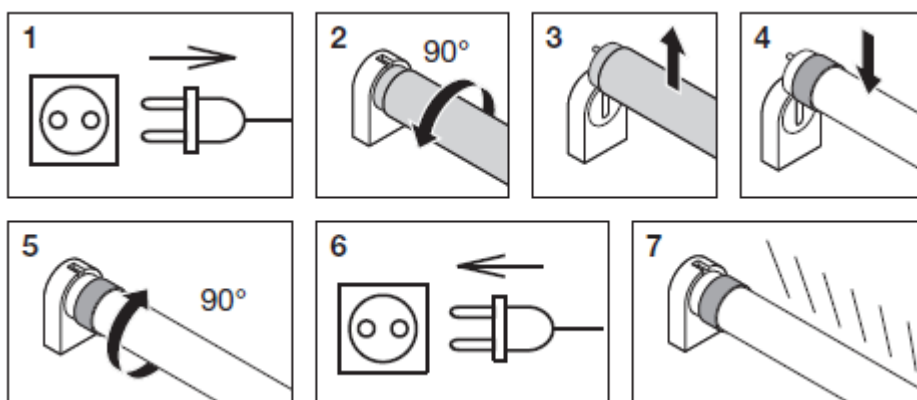

Link to the current compatibility list



Please check the compatibility of the ballast before installation.

3. SubstiTUBE® T8/T5 HF

3.2 Multi circuit lamp luminaires

Double lamp luminaires can be retrofitted analogue to single lamp luminaires. Only the fluorescent lamps must be replaced by **SubstiTUBE®** HF/UN tubes. An example wiring for luminaires with OSRAM® ECGs is shown below.

Circuit diagram of a retrofitted double lamp ECG luminaire

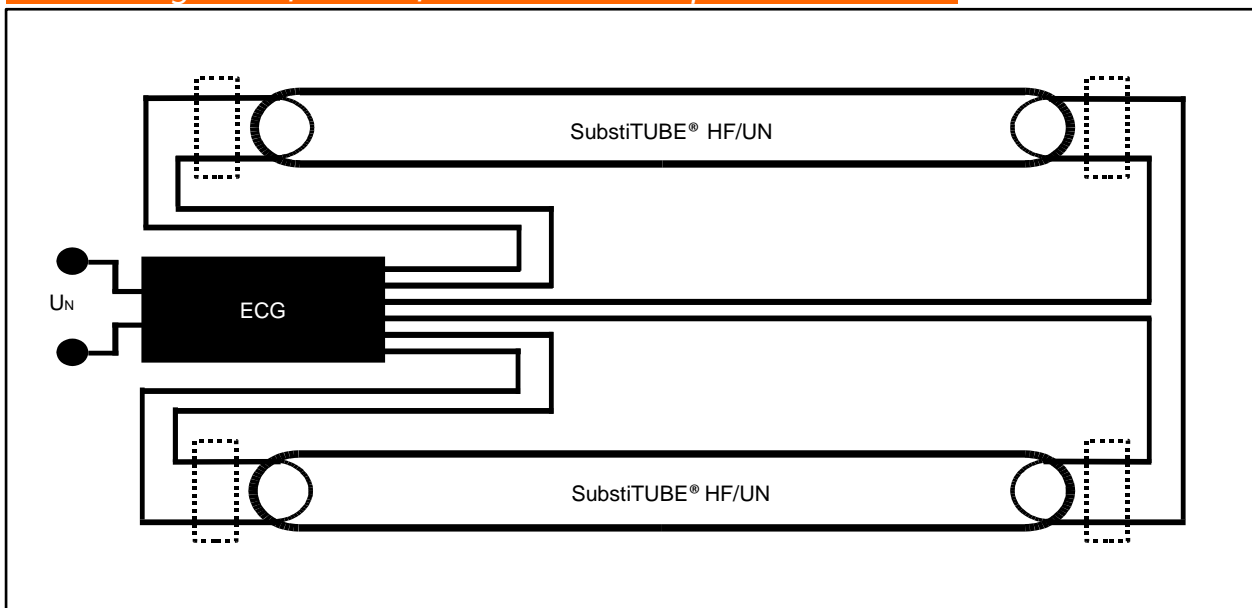

ECG luminaires with more than two lamps are wired similarly.

However, **the wiring of the luminaire remains the same** after retrofitting with **SubstiTUBE®** HF/UN.

LEDVANCE does not accept any responsibility, warranty or liability when using ECGs not mentioned, marked as non-compatible ECGs or when using successor /different Reference No. models of tested ballasts.

Please check the compatibility of the ballast before installation.

Link to the current compatibility list



3. SubstiTUBE® T8/T5 HF

3.3 Compatibility list



How to read the ECG compatibility list for SubstiTUBE® HF/UN LED tubes.

Step 1

Check exact type of ECG in the luminaire before installation

Check ECG name and brand

e.g.: OSRAM QT-FIT8 1X36;
SIGNIFY HF-P 254/255



Check exact reference No. of ECG

Different reference No. of ECG can lead to different compatibility result

Step 2

Check if ECG is released in the compatibility list

			ST8PRO 1.2M 14W 40-70V HF	
			Product EAN10 No.	
			4058075545137	
			4058075545175	
			4058075545205	
	Model	Ref.no	L *	
OSRAM	QTP-OPTIMAL 1x18-40	AA5095703DG	1	OK
	QT-FIT 5/8 1x18-39	AA747180355	1	OK
	QTP8 1x36	A63162D00DG	1	OK
	QT-FIT 8 1x36	AA747060355	1	OK
	QTP 1X36/230-240	N/A	1	NO
	QTP8 2x36	A63166E00DG	2	OK
	QT-FIT 8 2x36	AA3750401DG	2	OK
	QT-FIT 5/8 2x18-39	AA440140555	2	OK
	QTP-OPTIMAL 2x18-40	AA5173205DG	2	OK

Need help?

If you're can't find ECGs in the compatibility list or other application support, please contact LEDVANCE GmbH prior to installation

Step 3

The operating temperature range of SubstiTUBE® LED tube is restricted. In case of doubt regarding suitability of the application, please measure "Tc max" - temperature on the marked Tc point on the product. (see 1.1)

4. SubstiTUBE® T8 UN

4.1 Retrofitting in a CCG luminaire

-> see 2.1 Retrofitting in a CCG luminaire

4.1.1 Luminaires with compensating capacitor

-> see 2.1.1 Luminaires with compensating capacitor

4.1.2 Duo circuit lamp luminaire

-> see 2.1.2 Duo circuit lamp luminaire

4.2 Retrofitting in an ECG luminaire

-> see 3.1 Retrofitting in an ECG luminaire

4.2.1 Multi circuit lamp luminaire

-> see 3.2 Multi circuit lamp luminaire

4.2.2 Compatibility list

-> see 3.3 Compatibility list

4.3 Conversion / Direct Wiring

-> see 2.3 Conversion / Direct Wiring

5. SubstiTUBE® T5 AC Mains

5.1 Conversion / Direct Wiring

SubstiTUBE® T5 AC Mains can only be operated on AC (220-240V) Mains.

Thus **SubstiTUBE® T5 AC Mains 220-240V** can be inserted in any direction with standardized IEC compliant G5 lamp holders. All wires need to be approved for the existing voltages and appliance class. Usually, solid wires with single isolation can be used for class I, double insulation wires could be used for class II. The maximum wire cross-section for lamp holders and starters is typically 0.5mm².

Built-in control gears must not remain connected after rewiring.

Direct wiring circuit diagram of a retrofitted luminaire

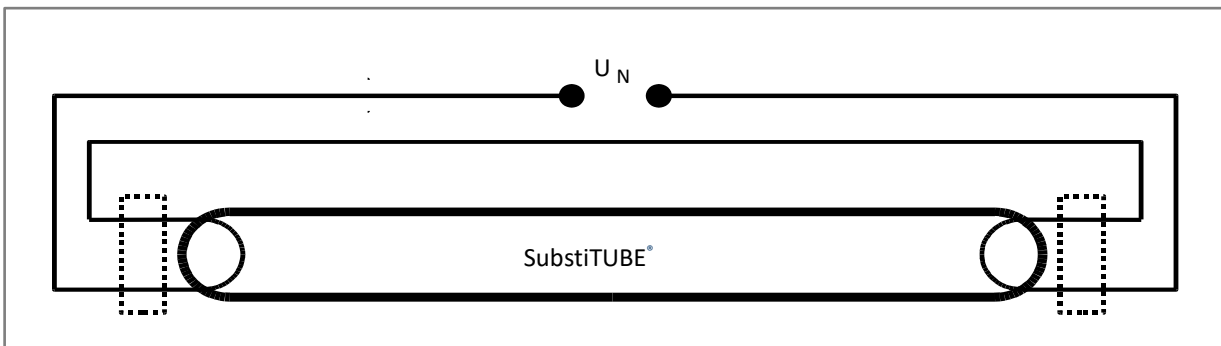

5. SubstiTUBE® T5 AC Mains

5.2 Installation instruction

Note: Rewiring by qualified electricians only.

1. Make sure that the luminaire is disconnected from the mains
2. Remove the conventional lamp
3. Rewire the luminaire as shown in the circuit diagram on the page before
4. Insert **SubstiTUBE®** T5 AC Mains into lamp holders
5. Make sure, that the rewired luminaire complies to all relevant safety requirements and other applicable regulations, e.g. acc. to DIN VDE 0701-0702 or 2004/108/EC by conducting appropriate tests.
6. Mark rewired luminaire with new name plate

Note: After rewiring only LED tubes can be used in this luminaire. The use of traditional fluorescent tubes is not permitted anymore.

Direct wiring circuit diagram of a retrofitted double lamp luminaire

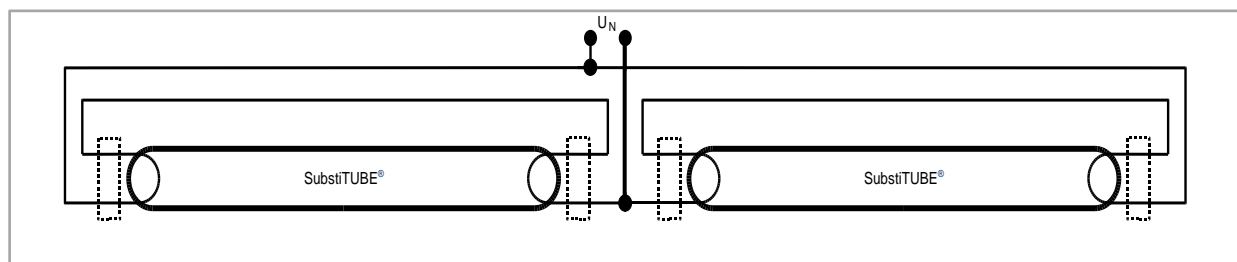

ABOUT LEDVANCE

With offices in more than 50 countries and business activities in more than 140 countries, LEDVANCE is one of the world's leading general lighting providers for professional users and end consumers. Having emerged from the general lighting business of OSRAM GmbH, LEDVANCE offers a wide-ranging assortment of LED luminaires for a broad spectrum of application areas, intelligent lighting products for Smart Homes and Buildings, one of the largest LED lamps portfolios in the industry as well as traditional light sources



LEDVANCE

LEDVANCE GmbH
Parkring 29 – 33
85748 Garching
Germany
LEDVANCE.COM

Subject to change without notice. Errors and omission excepted.

LEDVANCE ist Lizenznehmer der Produktmarke OSRAM für Lampen im Bereich Allgemeinbeleuchtung.

LEDVANCE.DE

