





QUICKTRONIC® FIT T5

	QT-FIT5 1x14-35	QT-FIT5 1x49	QT-FIT5 1x54	QT-FIT5 2x14-35	QT-FIT5 2x49	QT-FIT5 2x54	QT-FIT5 3x14; 4x14
10A (B) 	17 x 	17 x 	17 x 	12 x 	8 x 	8 x 	12 x 
16A (B/C) 	28 / 47 x 	28 / 47 x 	28 / 47 x 	19 / 32 x 	13 / 22 x 	13 / 22 x 	19 / 32 x 
	≤ 24 A	≤ 24 A	≤ 24 A	≤ 40 A	≤ 53 A	≤ 53 A	≤ 40 A
Th	230 μs	230 μs	230 μs	200 μs	200 μs	200 μs	200 μs

QT-FIT5 1x...

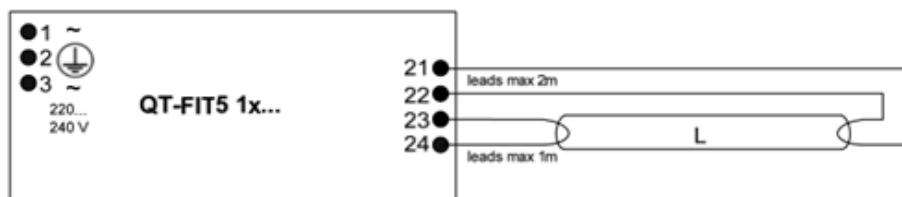

Max. permitted cable length in between ECG and lamp: 2.0 m (PIN 21, 22); 1.0 m (PIN 23, 24)

QT-FIT5 2x...

Max. permitted cable length in between ECG and lamp: 2.0 m (PIN 21, 22); 1.5 m (PIN 23, 24); 1.0 m (PIN 25, 26)

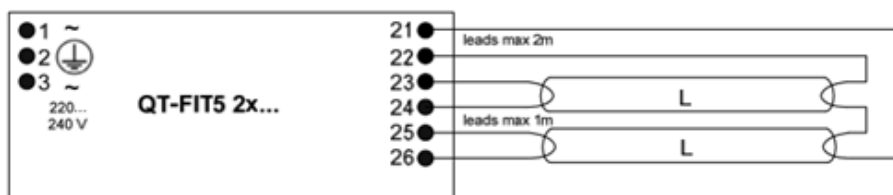

QT-FIT5 3x14, 4x14, 3 lamp operation

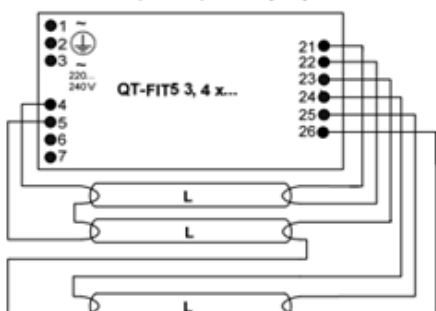

Max. permitted cable length in between ECG and lamp: 1.0 m (PIN 25, 26); 1.5 m (PIN 4, 5, 21, 22, 23, 24)

- (D) Max. Leitungslänge zwischen EVG und Lampe; Leitungslänge max.
- (RUS) Максимально допустимая длина кабеля между ЭГПА и лампой
- (KZ) Құрылғы мен шам арасындағы кабельдің максималды ұзындығы

1) **QUICKTRONIC® fit T5**
QT-FIT5 1x14-35

~lamp	U _n [V]	I _n [A]	f _n [Hz]	λ	t ₅₀ [°C]
1xHE14W	220...240	0.08	50/60	0.95	-15...50
1xHE21W		0.11		0.95	
1xHE28W		0.14		0.96	
1xHE35W		0.17		0.97	

2) 220 240V

3) Suitable for DC/Battery operation
Starting time < 2 sec.

4) U-OUT=330V
t_c = 75°C

5) Year
6) Week
7) Weekday

8) wire preparation
φ 0.5 - 1.5 mm
8 - 9 mm

Made in Bulgaria by OSRAM

OSRAM

9) P 14 25

(D) 1) Geeignet für DC/Batterie Betrieb; Startzeit 2) Lampe; 3) Drahtvorbereitung; 4) Hergestellt in Bulgarien von OSRAM; 5) Jahr; 6) Woche; 7) Wochentag (optional);

(RUS) 1) Подходит для DC ; 2) Лампа; 3) Подготовка кабеля; 4) Сделано в Болгарии компанией OSRAM; 5) Год; 6) Не-деля; 7) день недели (опционально)

(KZ) 1) Қолдану аясы DC; 2) Шам; 3) сымды дайындау; 4) Болгарияда OSRAM жасаған; 5) Жыл; 6) Апта; 7) Жұмыс күндері (таңдаулы)

Ⓔ Εισαγωγή & διάθεση: ΟΣΡΑΜ ΑΕ. Λ. Αθηνών 31-33, 104 47 Αθήνα

Ⓔ Ⓜ Производитель/Өндіруші: OSRAM GmbH, Марсель-Бройер-штрассе 6, 80807 Мюнхен, Германия. Импортер/Импорртаушы: ОАО «ОСРАМ» 214020 г. Смоленск/Смоленск қ., ул. Индустриальная 9-А/Индустриальная к., 9-А, тел.: +7 (4812) 62-86-00

Ⓔ Forgalmazó: OSRAM a.s. Mo-i Fióktelepe, 1119 Bp., Fehérvári út 84/A

Ⓔ Importer: OSRAM sp. z o.o., ul. Wiertnicza 117, 02-952 Warszawa

Ⓔ İthalatçı: OSRAM Aydınlatma Tic. A.Ş., Nispetiye Mah., Başlık Sok., MM Plaza, No:3 K:2, Etiler Beşiktaş İstanbul, +90 212 306-9000

Ⓔ OSRAM Romania SRL, Soseaua Bucuresti Nord Nr. 10, Global City Business Park, Cladirea O21, etaj 10, 077190 Voluntari, judetul Ilfov

Ⓔ Производитель: OSRAM GmbH, Доставчик: ОСРАМ ЕООД, 1505 София, бул. Ситняково 48, офис 604, +359 - (0)2 - 9712262

Ⓔ Uvoznik: OSRAM d.o.o., Đorđa Stanojevića 14, 11070 Beograd, Srbija

Ⓔ Виробник: OSRAM GmbH, 80920 Мюнхен, Німеччина. Імпортер: ПП „ОСРАМ Україна“, вул. Димитрова, 5, 03150 Київ, Україна



23.05.17
G-10557912

OSRAM GmbH
Steinerne Furt 62
86167 Augsburg
Germany
www.osram.com
www.osram.ru/EAC

OSRAM