

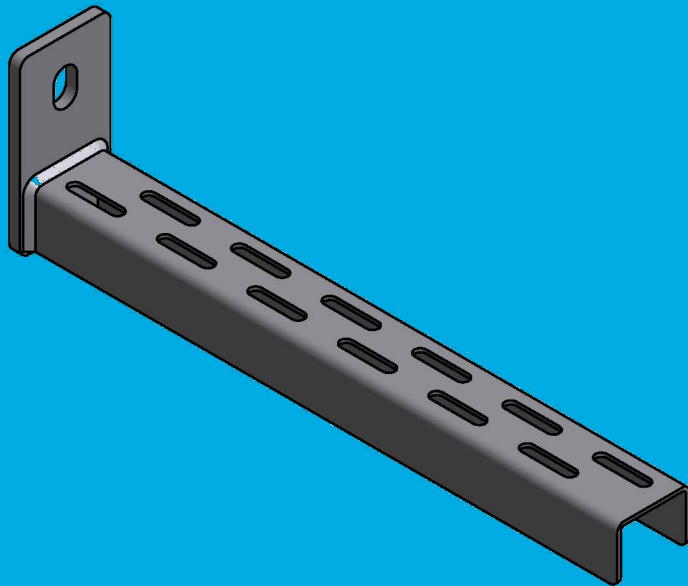

CONSOLES PLATES CPN





- NOUVELLES CONSOLES PLATES CPN**

Ces consoles pour chemins de câbles fil ou tôle ont leurs encombrements réduits et conviennent parfaitement pour les extrémités des pendants type STRUT 41x41 ou HU 5050.

CONSOLES PLATES CPN

 p	Désignation	Code	Masse kg/p	H. mm	L. mm	 daN
EZ 20	CPN 100 EZ	613170	0.385	95	125	300
10	CPN 200 EZ	613172	0.520	95	225	200
10	CPN 300 EZ	613173	0.655	95	325	150
10	CPN 400 EZ	613174	0.790	95	425	105
10	CPN 500 EZ	613175	0.925	95	525	95
10	CPN 600 EZ	613176	1.060	95	625	70

 p	Désignation	Code	Masse kg/p	H. mm	L. mm	 daN
GC 20	CPN 100 GC	614170	0.424	95	125	300
10	CPN 200 GC	614172	0.572	95	225	200
10	CPN 300 GC	614173	0.721	95	325	150
10	CPN 400 GC	614174	0.869	95	425	105
10	CPN 500 GC	614175	1.018	95	525	95
10	CPN 600 GC	614176	1.166	95	625	70

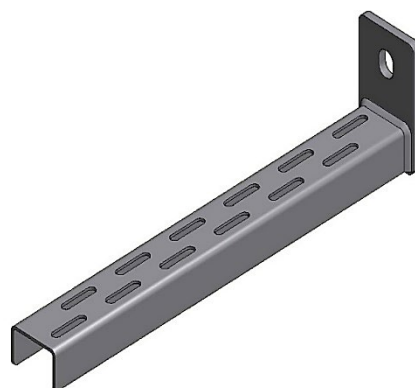

EZ : acier zingué par dépôt électrolytique et chromatisation selon ISO 2081 - ISO 2082 - NFA 91-472

GC : acier galvanisé à chaud après fabrication selon ISO 1461 - BS 729 - ASTM A123

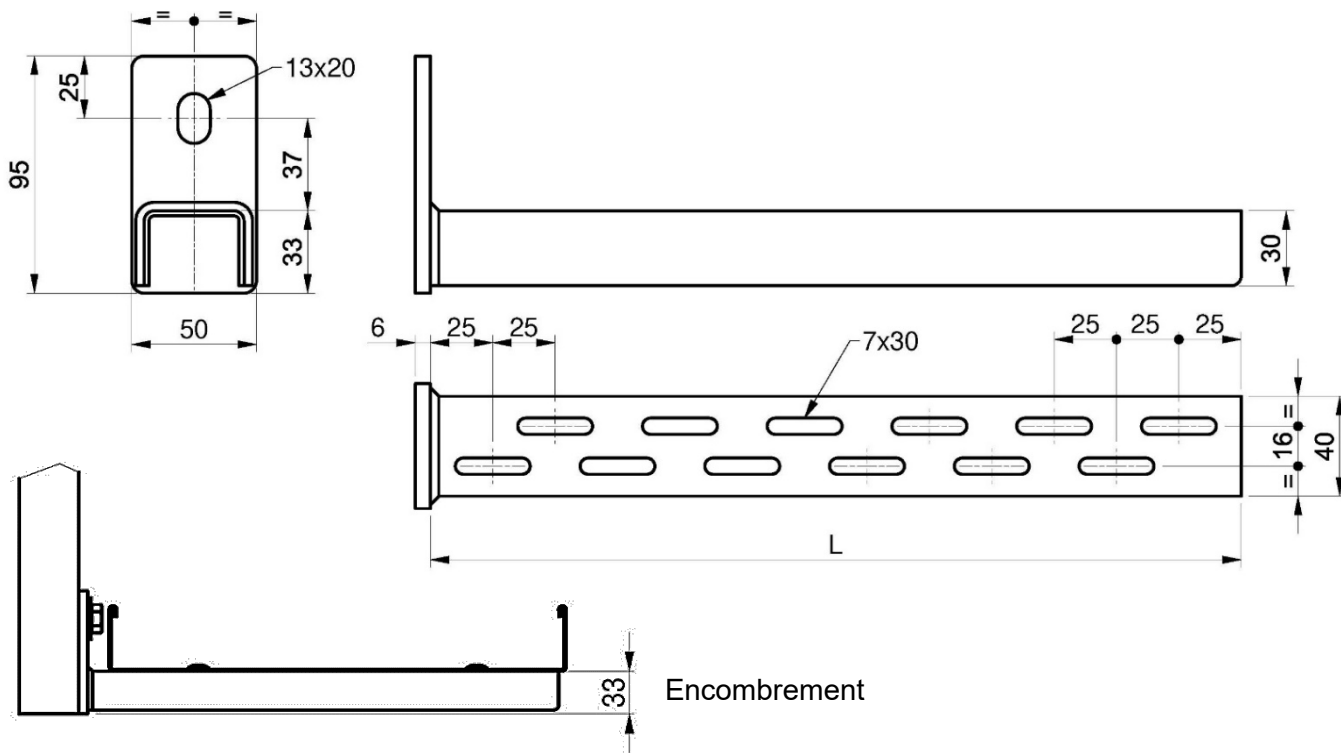

MONTAGE MURAL

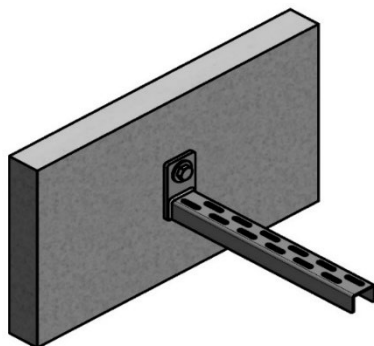

MONTAGE SUR RAIL STRUT 41

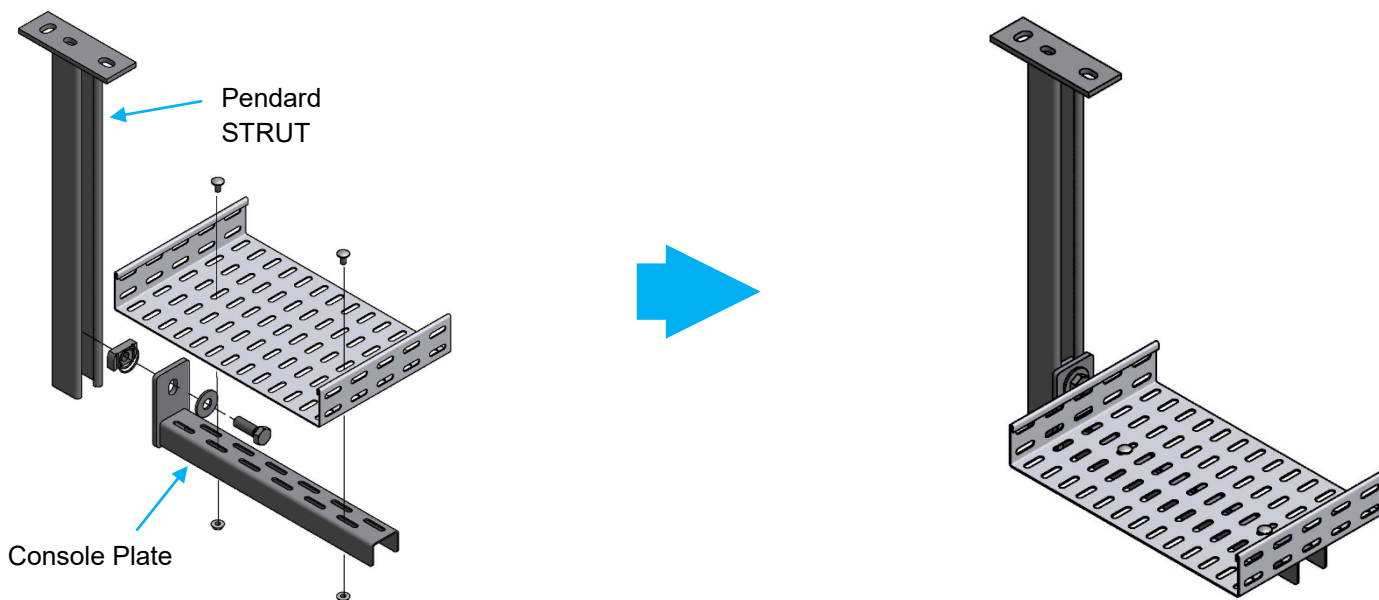

MONTAGE SUR RAIL U 5050

