

Module de touche, F40, Série LS, Laiton ancien

Reference number:	ME 2403 TSA AT
EAN/GTIN:	4011377093799
Couleur:	Laiton ancien
Matière:	Métal
xFach Modul:	3 voies

■ Possibilité d'impression individuelle en couleur

Finitions métalliques

Se monte sur les modules F 40, 3 voies

Art. N° : LS 4293 IST, 4093 TSEM, 4073 RF TSM, 4236 TSM, 4008 TSM, FM 4003 M

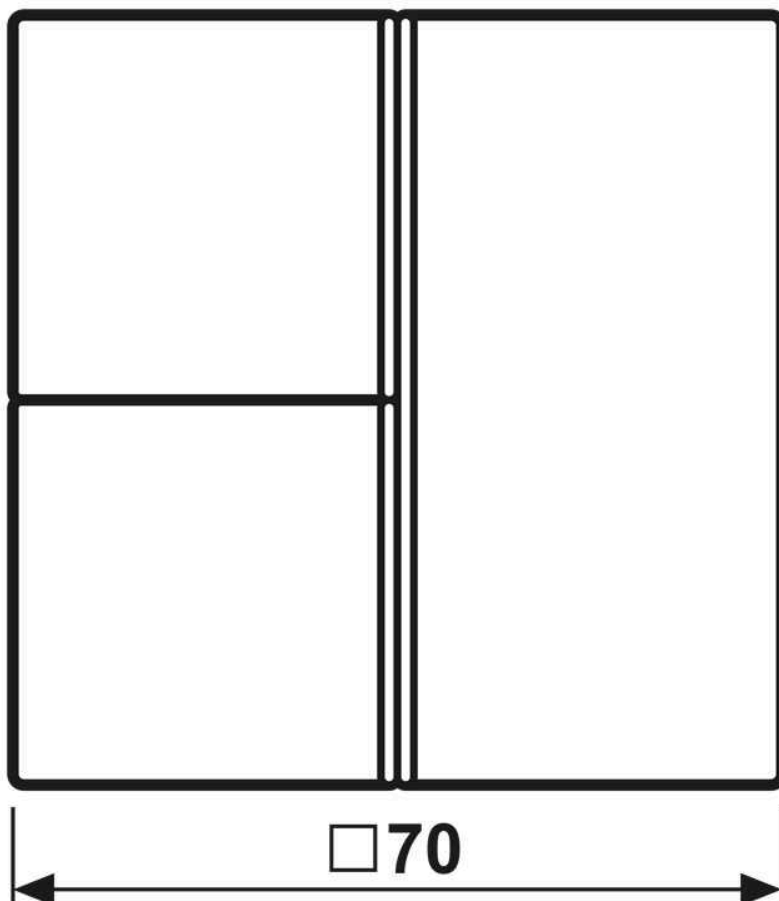
Dimensions

Montage

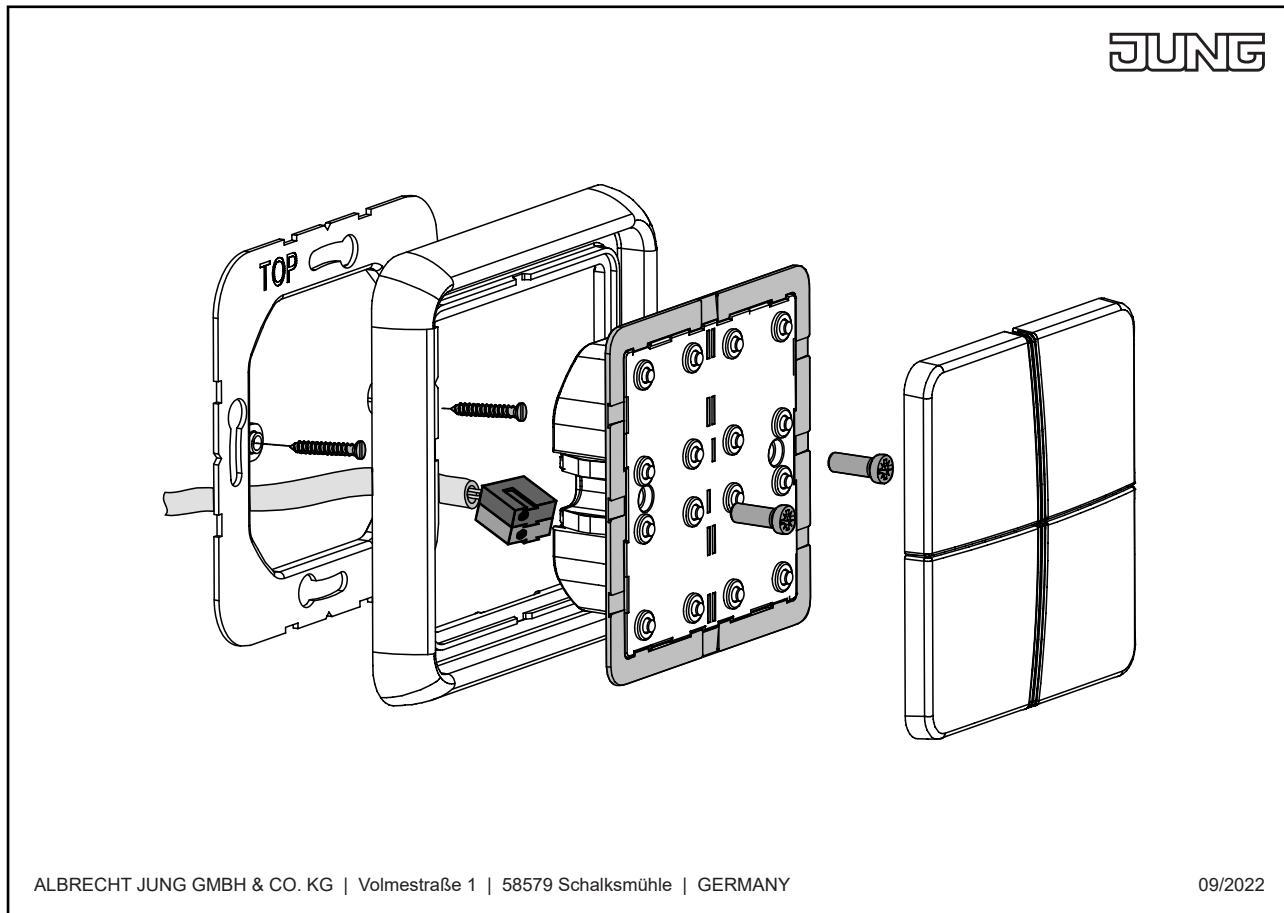

ALBRECHT JUNG GMBH & CO. KG | Volmestraße 1 | 58579 Schalksmühle | GERMANY

09/2022