

Étrier de jonction - Sintesi

Code: 22025876-00

INFORMATIONS GÉNÉRALES

Article	Étrier de jonction - Sintesi
Code	22025876-00

DIMENSIONS ET POIDS

Longueur (mm)	120 mm
Largeur (mm)	50 mm
Hauteur (mm)	19 mm
Poids (Kg)	0.1 kg



en tôle galvanisée. Pour l'alignement mécanique des profils.



Étrier de jonction - Sintesi

Code: 22025876-00



Étrier de jonction - Sintesi

Code: 22025876-00

MATÉRIAUX ET COULEURS

Corps	en tôle galvanisée. Pour l'alignement mécanique des profils.
Couleur	Galvanisé

GARANTIE

Garantie après-vente	0 yr
----------------------	------

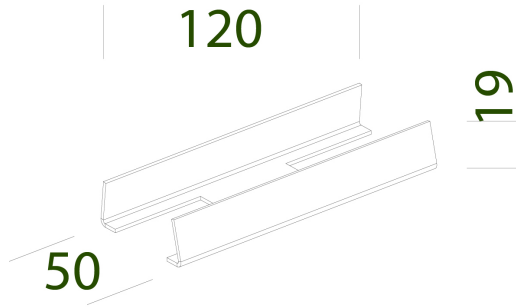

TÉLÉCHARGEMENT

DESSINS

DessinTechnique 22025876.dxf



Étrier de jonction - Sintesi

Code: 22025876-00

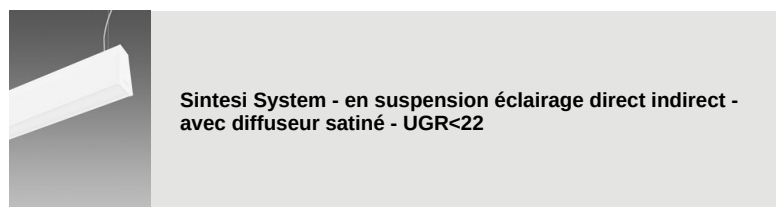
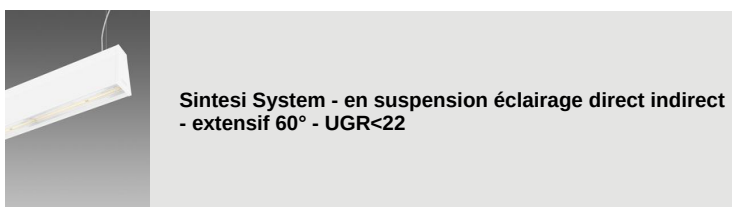
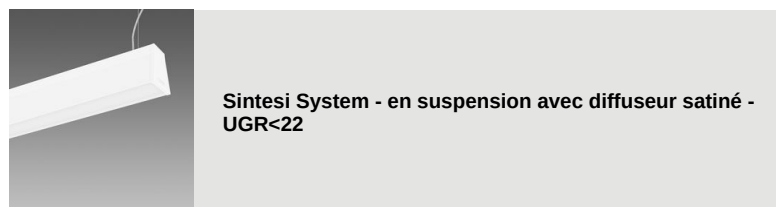
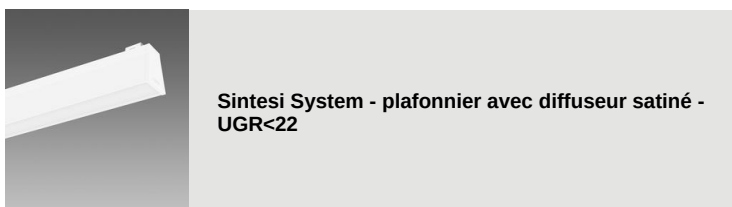
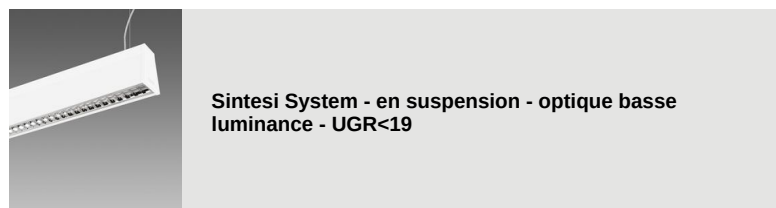
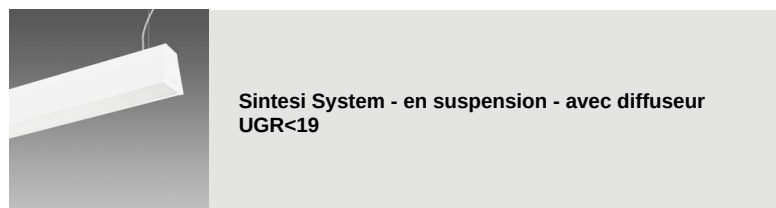
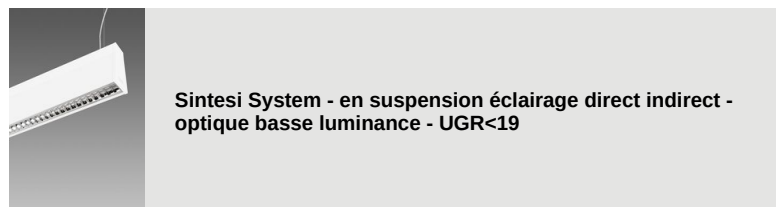
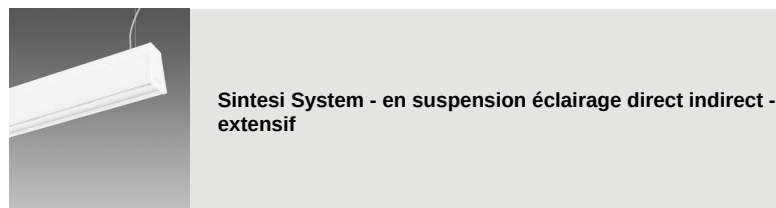
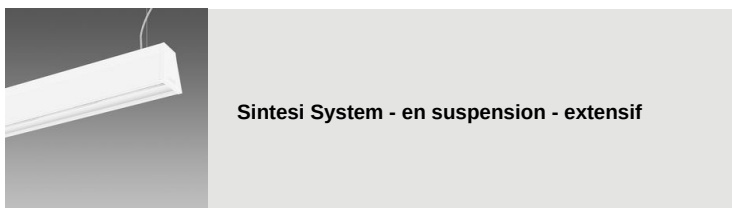

Étrier de jonction - Sintesi

Code: 22025876-00



**Sintesi System - en suspension éclairage direct indirect
- avec diffuseur UGR<19**