

Embout de fermeture 1 - Sintesi

Code: 22025812-00

INFORMATIONS GÉNÉRALES

Article	Embout de fermeture 1 - Sintesi
Code	22025812-00

DIMENSIONS ET POIDS

Longueur (mm)	69 mm
Largeur (mm)	7 mm
Hauteur (mm)	88 mm
Poids (Kg)	0.1 kg



en polycarbonate pour fermer l'extrémité de la composition linéaire. Pour version avec diffuseur, optique basse luminance et lentille extensive.



Embout de fermeture 1 - Sintesi

Code: 22025812-00



Embout de fermeture 1 - Sintesi

Code: 22025812-00

MATÉRIAUX ET COULEURS

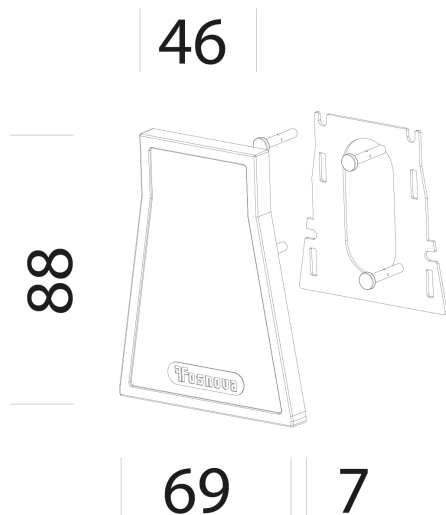

Corps	en polycarbonate pour fermer l'extrémité de la composition linéaire. Pour version avec diffuseur, optique basse luminance et lentille extensive.
-------	--

Couleur	Blanc
---------	-------

GARANTIE

Garantie après-vente	0 yr
----------------------	------

TÉLÉCHARGEMENT

DESSINS

DessinTechnique 22025812.dxf



Embout de fermeture 1 - Sintesi

Code: 22025812-00

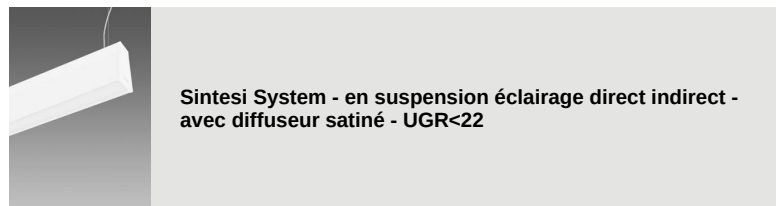
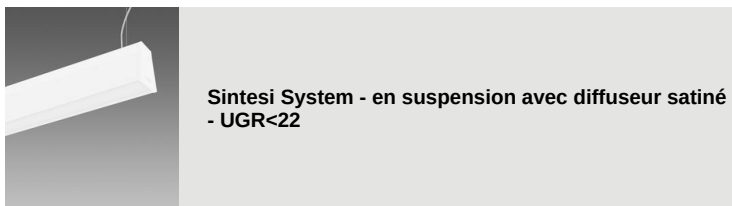
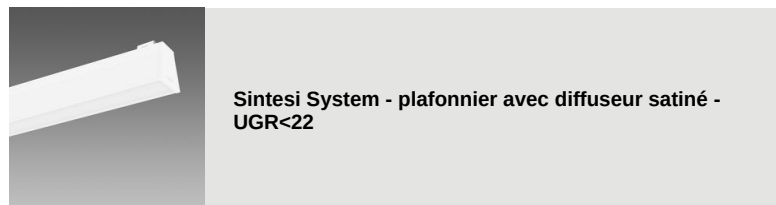
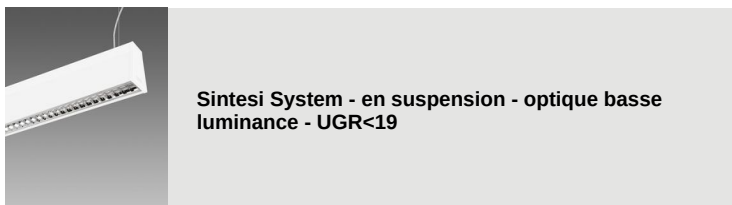
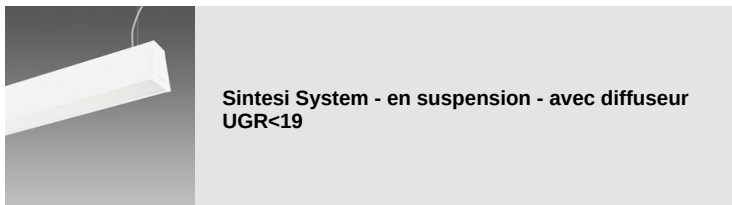
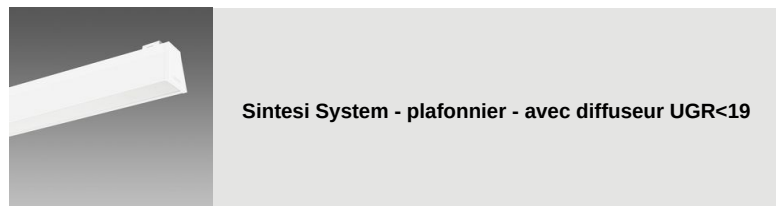
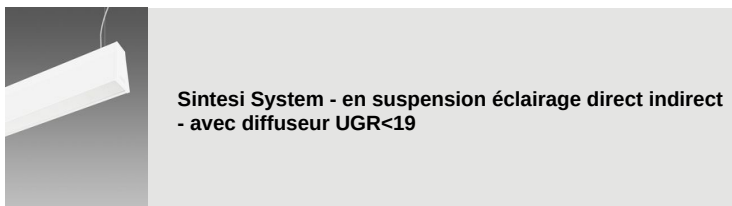
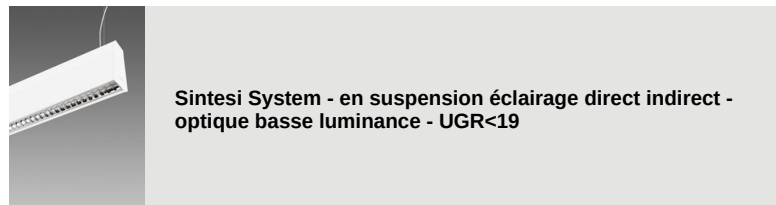
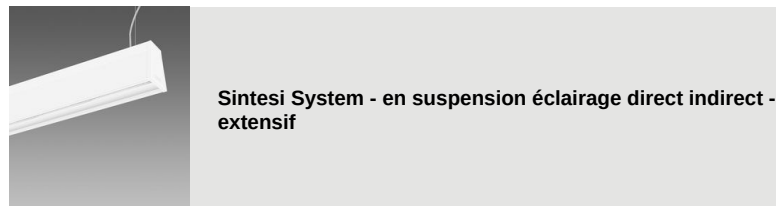
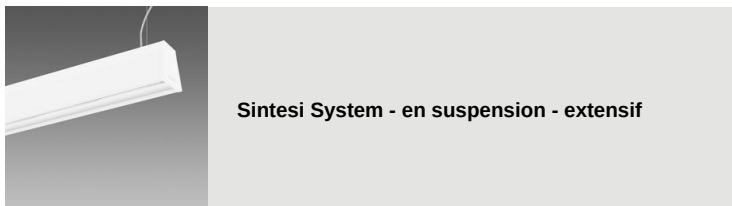

Embout de fermeture 1 - Sintesi

Code: 22025812-00



**Sintesi System - en suspension éclairage direct indirect
- extensif 60° - UGR<22**