

# HERO B

1087D0.02

**novalux**  
ITALIAN LIGHTING DESIGN SINCE 1948

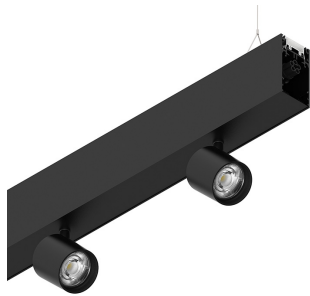

## Features

Use: Indoor  
Type of installation: SUSPENDED  
Emission: DIRECT/INDIRECT  
Optics: SPOT  
Beam: 34°  
Colour: BLACK  
Dimming: PUSH  
Emergency: NO  
L: 1120mm  
A: 53mm  
H: 92mm  
Made in: ITALY  
Warranty: 5 years  
Weight: 2.5kg

## Tech data

Luminaire input power: 48.5W  
Luminaire luminous flux: 4353lm  
Direct luminous flux: 2230lm  
Indirect luminous flux: 2123lm  
IP: 40  
Insulation class: I  
No. of driver per product: 2  
Supply voltage: 220-240V 50/60Hz  
SELV: Si

## Source

Light source: LED  
Source power: 2x13+18W  
Colour temperature: 3000K  
CRI: >90  
Colour tolerance: 3 Step MacAdam  
LED lifespan: 50000h L80 B20

## Compliance

CEI EN 60598-1:2021 + A11:2023, CEI EN 60598-2-1:2022

## Standards

Photobiological risk: RISK GROUP 1 Certified fixture in RISK GROUP 1 (Low Risk)-The fixture does not pose a hazard due to normal behavioral limitations on exposure - in accordance with CEI EN 62471:2010-01, IEC TR 62778:2014.

CAM edilizia: The product complies with the requirements for public buildings, ministerial decree of 23rd June 2022 n.256.

[View more product info](#)

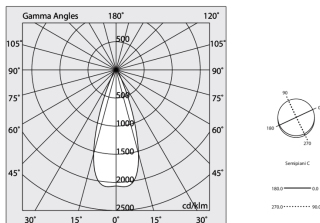
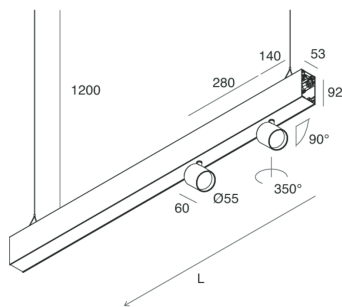

Novalux S.r.l. via Marzabotto, 2 40050 Funo di Argelato (BO) Italy  
Tel: +39 051 860558 · Fax +39 051 6647859 · Mail: info@novalux.it · VAT number 00536541204 · novalux.com  
Company subject to the management and coordination by SLV GmbH







This technical data sheet is owned by Novalux S.r.l., all rights reserved. Novalux S.r.l. reserves the right to make changes without prior notice.  
Last update: 14/11/2024, 18:43:44

# HERO B

1087D0.02

**novalux**  
ITALIAN LIGHTING DESIGN SINCE 1948

## COMPLETION ACCESSORIES

	HERO B: MOD.CIECO 250 NE	<b>1087A3.02</b>
	HERO B: MOD.CIECO ANG.SX 150 NE	<b>1087A4.02</b>
	HERO B: MOD.CIECO ANG.DX 150 NE	<b>1087A5.02</b>
	HERO B: MOD.CIECO 1120 NE	<b>1087A6.02</b>
	HERO B: MOD.CIECO 1400 NE	<b>1087A7.02</b>
	HERO B: MOD.CIECO 1680 NE	<b>1087A8.02</b>
	HERO B: COPPIA TESTATE NE	<b>1087B1.02</b>

## MOUNTING ACCESSORIES

	HERO B: KIT COPPIA CAVI SOSP. 5 M	<b>1087B2.99</b>
	KIT ALIMENTAZIONE L1200 5P BIA	<b>108921.01</b>
	KIT ALIMENTAZIONE L1200 5P NE	<b>108921.02</b>
	KIT ALIMENTAZIONE L3000 5P BIA	<b>108922.01</b>



Novalux S.r.l. via Marzabotto, 2 40050 Funo di Argelato (BO) Italy  
Tel: +39 051 860558 · Fax +39 051 6647859 · Mail: info@novalux.it · VAT number 00536541204 · novalux.com  
Company subject to the management and coordination by SLV GmbH

This technical data sheet is owned by Novalux S.r.l., all rights reserved. Novalux S.r.l. reserves the right to make changes without prior notice.  
Last update: 14/11/2024, 18:43:44

# HERO B

1087D0.02

**novalux**  
ITALIAN LIGHTING DESIGN SINCE 1948



KIT ALIMENTAZIONE L3000 5P NE

**108922.02**



Novalux S.r.l. via Marzabotto, 2 40050 Funo di Argelato (BO) Italy  
Tel: +39 051 860558 · Fax +39 051 6647859 · Mail: [info@novalux.it](mailto:info@novalux.it) · VAT number 00536541204 · [novalux.com](http://novalux.com)  
Company subject to the management and coordination by SLV GmbH

This technical data sheet is owned by Novalux S.r.l., all rights reserved. Novalux S.r.l. reserves the right to make changes without prior notice.  
Last update: 14/11/2024, 18:43:44