



Electrical features

Maximum operating current ($\leq 440V$)	A	9
---	---	---

Contact characteristics

Operational current Ie	AC-3 ($\leq 440V \leq 55^\circ C$)	A	9
Rated operational power AC-3 ($T \leq 55^\circ C$)	230V	kW	2.2
	400V	kW	4
	415V	kW	4.3
	440V	kW	4.5
	500V	kW	5

Built-in auxiliary contacts

NO	0
NC	1

UL technical data

Maximum UL/CSA horsepower ratings single-phase	110V-120V	HP	0.5
	220V-240V	HP	1.5
Maximum UL/CSA horsepower ratings three-phase, 3-pole	200V-208V	HP	2
	220V-240V	HP	3
	440V-480V	HP	5

Mechanical features

Terminals type	Clamp screw
Weight	g 460

Dimensions

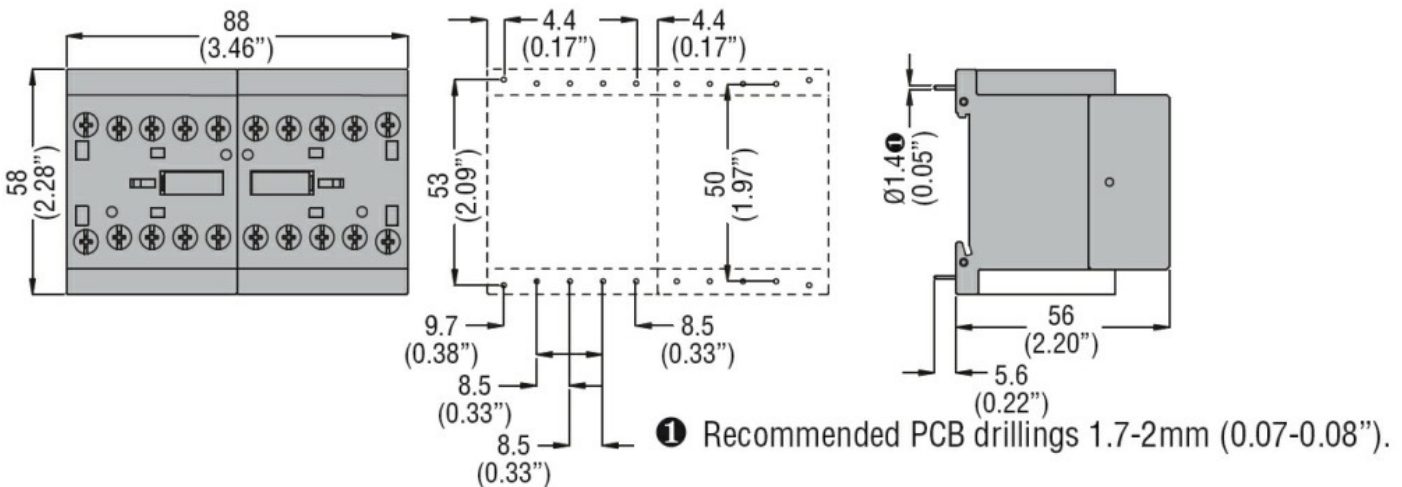

Wiring diagrams

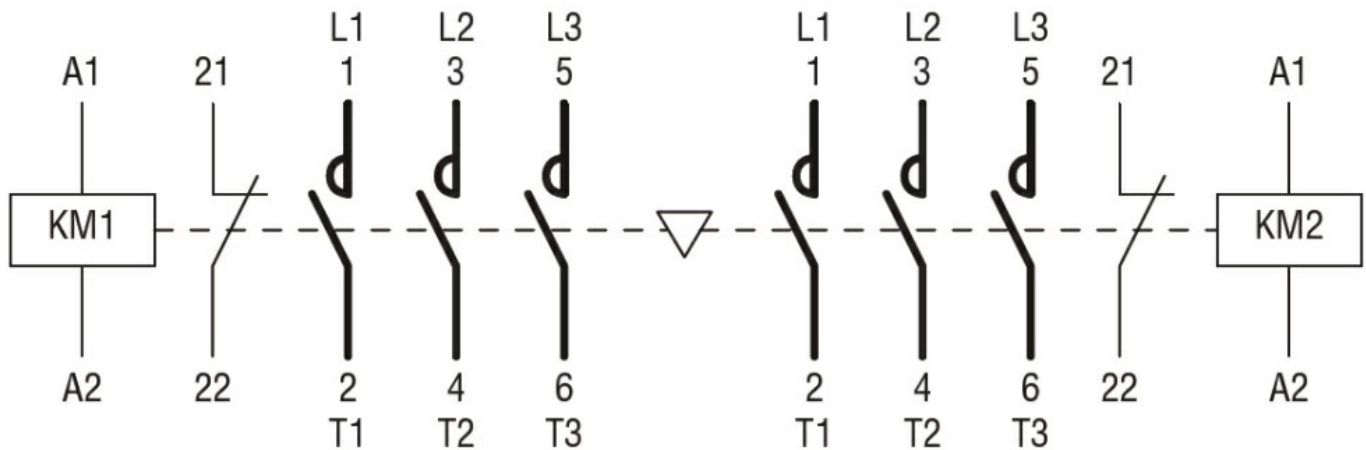

Certifications and compliance

Compliance

IEC/EN 60947-1

IEC/EN 60947-4-1

UL508 CSA C22.2 n° 14

Certificates

cULus

ETIM classification

ETIM 8.0

EC001037 -
Motor
starter/Motor
starter
combination