



**Connections**

Terminals type Threaded rod with nut

**Ambient conditions**

Temperature Operating temperature max °C +180

Maximum operating pressure bar 10

**Housing**

Weight g 281

**Dimensions**

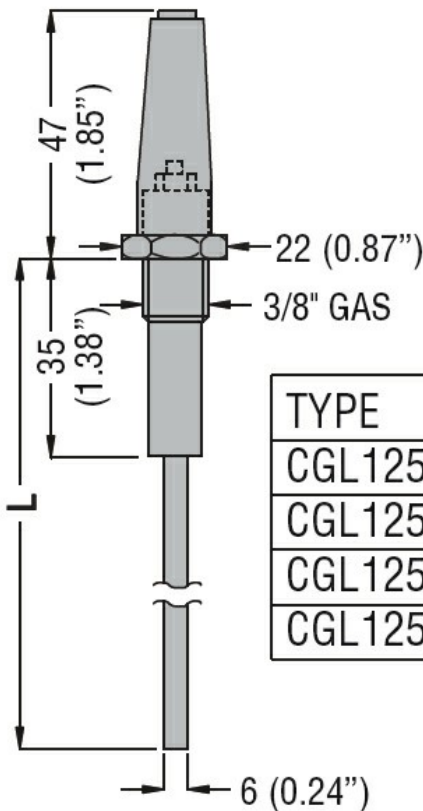

TYPE	L
CGL125 3	327 (12.87")
CGL125 5	500 (19.68")
CGL125 7	700 (27.56")
CGL125 10	1000 (39.37")

**Certifications and compliance**

Compliance /

Certificates EAC

**ETIM classification**

ETIM 8.0 EC010106 - Liquid level sensor