

General characteristics

Switching diagram	86 - Multi-step 1-2-3 2 poles
N° of elements	3
Mounting form	O48 - Modular service cover for 35mm din rail mounting with black handle

Contact characteristics

Rated insulation voltage U_i	IEC/EN	V	690	
	UL/CSA	V	600	
Rated impulse withstand voltage U_{imp}		kV	6	
Conventional free air thermal current I_{th}	IEC/EN	A	16	
	UL/CSA	A	15	
Rated operational voltage		V	480	
Rated operational impulse voltage		kV	4	
Maximum fuse size for short-circuit protection I_n (gG)	10kA	A	16	
	15kA	A	10	
	25kA	A	10	
Rated short time current I_{cw}	1s	kA	200	
	Conductivity			10/5 mA/V
Operational current I_e IEC/EN	AC1/AC21A		A	16
	AC15			
	110V	A	10	
	220/230V	A	8	
	380/400V	A	4	
	660/690V	A	1.5	
Rated operational power in AC	Three-phase AC-3			
	220/230V	kW	2.5	
	380/440V	kW	4	
	500/690V	kW	5.5	
	Single-phase AC-3			
	110V	kW	0.8	
	220/230V	kW	1.5	
	380/440V	kW	2.2	
	Three-phase AC23A			
	220/230V	kW	3	
	380/440V	kW	5.5	
	500/690V	kW	7.5	
Single-phase AC23A				
110V	kW	0.8		
220/230V	kW	1.7		
380/440V	kW	3		
Rated operational current in DC				
DC21A				

	48V	A	12
	60V	A	12
	110V	A	4
	220V	A	0.6
	440V	A	0.25
<hr/>			
DC23A (poles in series)	24V	A	10 (1)
	48V	A	10 (2)
	60V	A	10 (3)
	110V	A	5 (3)
	220V	A	5 (4)
<hr/>			
DC13	24V	A	12
	48V	A	10
	60V	A	8
	110V	A	1
	220V	A	0.4
	440V	A	0.15
<hr/>			
Power dissipation		W	0.8
Mechanical features			
Terminals screw			M3
Tightening torque for terminals max		Nm	0.5
<hr/>			
Conductor size			
AWG - Rigid cable	min	AWG	20
	Max	AWG	12
<hr/>			
AWG - Flexible cable	min	AWG	20
	Max	AWG	14
<hr/>			
Conductor size (IEC) - Flexible cable	min	mm ²	0.5
	Max	mm ²	2.5
<hr/>			
Conductor size (IEC) - Rigid cable	min	mm ²	0.5
	Max	mm ²	2.5
<hr/>			
Mechanical life		cycles	3x10 ⁶
UL technical data			
Motor power for direct-on-line control			
for three-phase motor	120V	HP	1.5
	240V	HP	3
<hr/>			
for single-phase motor	120V	HP	0.5
	240V	HP	1
<hr/>			
Ambient conditions			
Temperature			
Operating temperature	min	°C	-25
	max	°C	+55
<hr/>			
Storage temperature	min	°C	-40
	max	°C	+70
<hr/>			
Resistance & Protection			
Frontal IP degree			IP40

Terminals IP degree

IP00

Dimensions

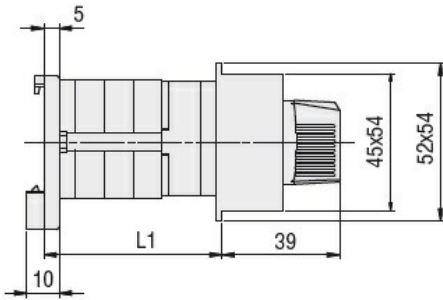

Series	L1		
	1	2	3
7GN12	38.1	47.8	57.5
7GN20	38.1	47.8	57.5
7GN25	42.5	56.1	69.7

Wiring diagrams

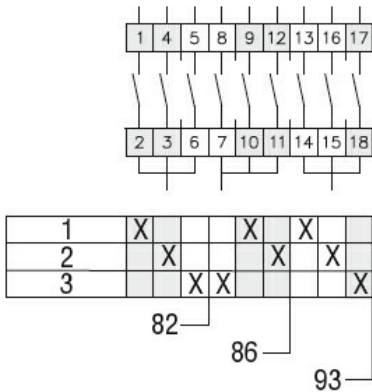

Certifications and compliance

Compliance

- CSA C22.2 n° 14

- IEC/EN/BS 60947-1

- IEC/EN/BS 60947-3

- IEC/EN/BS 60947-5-1

- UL60947-4-1

Certificates

- cCSAus

- EAC

- UL

ETIM classification

ETIM 8.0

EC001029 -
Selector switch,
complete