



### General characteristics

Switching diagram	92 - ON/OFF switch 4 poles
N° of elements	2
Mounting form	O48 - Modular service cover for 35mm din rail mounting with black handle

### Contact characteristics

Rated insulation voltage $U_i$	IEC/EN	V	690
	UL/CSA	V	600
Rated impulse withstand voltage $U_{imp}$		kV	6
Conventional free air thermal current $I_{th}$	IEC/EN	A	16
	UL/CSA	A	15
Rated operational voltage		V	480
Rated operational impulse voltage		kV	4
Maximum fuse size for short-circuit protection $I_n$ (gG)	10kA	A	16
	15kA	A	10
	25kA	A	10
Rated short time current $I_{cw}$	1s	kA	200
			10/5 mA/V
Conductivity			10/5 mA/V
Operational current $I_e$ IEC/EN	AC1/AC21A	A	16
	AC15		
	110V	A	10
	220/230V	A	8
	380/400V	A	4
	660/690V	A	1.5
Rated operational power in AC	Three-phase AC-3		
	220/230V	kW	2.5
	380/440V	kW	4
	500/690V	kW	5.5
Single-phase AC-3			
	110V	kW	0.8
	220/230V	kW	1.5
	380/440V	kW	2.2
Three-phase AC23A			
	220/230V	kW	3
	380/440V	kW	5.5

	500/690V	kW	7.5
Single-phase AC23A			
	110V	kW	0.8
	220/230V	kW	1.7
	380/440V	kW	3
Rated operational current in DC			
DC21A			
	48V	A	12
	60V	A	12
	110V	A	4
	220V	A	0.6
	440V	A	0.25
DC23A (poles in series)			
	24V	A	10 (1)
	48V	A	10 (2)
	60V	A	10 (3)
	110V	A	5 (3)
	220V	A	5 (4)
DC13			
	24V	A	12
	48V	A	10
	60V	A	8
	110V	A	1
	220V	A	0.4
	440V	A	0.15
Power dissipation		W	0.8
<b>Mechanical features</b>			
Terminals screw			M3
Tightening torque for terminals max		Nm	0.5
Conductor size			
AWG - Rigid cable			
	min	AWG	20
	Max	AWG	12
AWG - Flexible cable			
	min	AWG	20
	Max	AWG	14
Conductor size (IEC) - Flexible cable			
	min	mm <sup>2</sup>	0.5
	Max	mm <sup>2</sup>	2.5
Conductor size (IEC) - Rigid cable			
	min	mm <sup>2</sup>	0.5
	Max	mm <sup>2</sup>	2.5
Mechanical life		cycles	3x10 <sup>6</sup>
<b>UL technical data</b>			
Motor power for direct-on-line control			
for three-phase motor			
	120V	HP	1.5
	240V	HP	3
for single-phase motor			
	120V	HP	0.5
	240V	HP	1

**Ambient conditions**

Temperature

Operating temperature

min	°C	-25
max	°C	+55

Storage temperature

min	°C	-40
max	°C	+70

**Resistance & Protection**

Frontal IP degree	IP40
Terminals IP degree	IP00

**Dimensions**

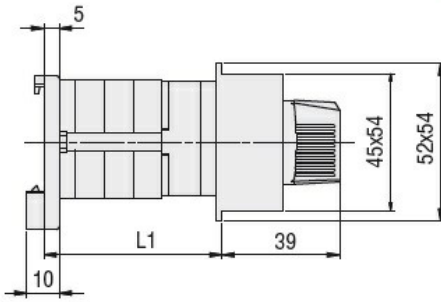

Series	L1		
	1	2	3
<b>7GN12</b>	38.1	47.8	57.5
<b>7GN20</b>	38.1	47.8	57.5
<b>7GN25</b>	42.5	56.1	69.7

**Wiring diagrams**

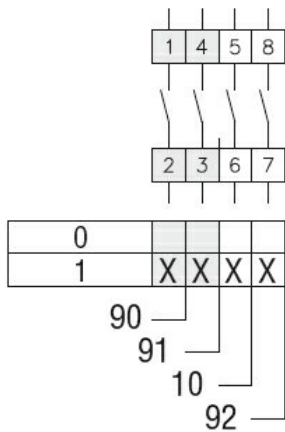

**Certifications and compliance**

**Compliance**

- CSA C22.2 n° 14
- IEC/EN/BS 60947-1
- IEC/EN/BS 60947-3
- IEC/EN/BS 60947-5-1
- UL60947-4-1

**Certificates**

- cCSAus
- EAC
- UL

**ETIM classification**

ETIM 8.0

EC001029 -  
Selector switch,  
complete