

**General characteristics**

Switching diagram	135 - Multi-step 0-1-2 3 poles
N° of elements	3
Mounting form	O48 - Modular service cover for 35mm din rail mounting with black handle

**Contact characteristics**

Rated insulation voltage $U_i$	IEC/EN	V	690	
	UL/CSA	V	600	
Rated impulse withstand voltage $U_{imp}$		kV	6	
Conventional free air thermal current $I_{th}$	IEC/EN	A	25	
	UL/CSA	A	30	
Rated operational voltage		V	480	
Rated operational impulse voltage		kV	4	
Maximum fuse size for short-circuit protection $I_n$ (gG)	10kA	A	25	
	15kA	A	25	
	25kA	A	25	
Rated short time current $I_{cw}$	1s	kA	400	
			10/5 mA/V	
Conductivity			10/5 mA/V	
Operational current $I_e$ IEC/EN	AC1/AC21A	A	25	
	AC15			
	110V	A	16	
	220/230V	A	12	
	380/400V	A	8	
	660/690V	A	2	
Rated operational power in AC	Three-phase AC-3	220/230V	kW	5.5
		380/440V	kW	7.5
		500/690V	kW	7.5
	Single-phase AC-3	110V	kW	1.5
		220/230V	kW	3
		380/440V	kW	5.5
	Three-phase AC23A	220/230V	kW	6.5
		380/440V	kW	11
		500/690V	kW	11
	Single-phase AC23A	110V	kW	1.5
		220/230V	kW	3.7
		380/440V	kW	5.5
Rated operational current in DC				
DC21A				

	48V	A	25
	60V	A	25
	110V	A	4
	220V	A	0.7
<hr/>			
DC23A (poles in series)	24V	A	25 (1)
	48V	A	25 (2)
	60V	A	25 (3)
	110V	A	12 (3)
	220V	A	10 (4)
<hr/>			
DC13	24V	A	25
	48V	A	20
	60V	A	16
	110V	A	1.5
	220V	A	0.4
<hr/>			
Power dissipation		W	1.1
<b>Mechanical features</b>			
Terminals screw			M3.5
Tightening torque for terminals max		Nm	0.8
<hr/>			
Conductor size			
AWG - Rigid cable	min	AWG	20
	Max	AWG	10
<hr/>			
AWG - Flexible cable	min	AWG	20
	Max	AWG	12
<hr/>			
Conductor size (IEC) - Flexible cable	min	mm <sup>2</sup>	0.5
	Max	mm <sup>2</sup>	4
<hr/>			
Conductor size (IEC) - Rigid cable	min	mm <sup>2</sup>	0.5
	Max	mm <sup>2</sup>	4
<hr/>			
Mechanical life		cycles	5x10 <sup>6</sup>
<b>UL technical data</b>			
Motor power for direct-on-line control			
for three-phase motor	120V	HP	3
	240V	HP	5
	480V	HP	10
	600V	HP	15
<hr/>			
for single-phase motor	120V	HP	1.5
	240V	HP	3
<hr/>			
<b>Ambient conditions</b>			
Temperature			
Operating temperature	min	°C	-25
	max	°C	+55
<hr/>			
Storage temperature	min	°C	-40
	max	°C	+70
<hr/>			
<b>Resistance &amp; Protection</b>			
Frontal IP degree			IP40

Terminals IP degree

IP00

**Dimensions**

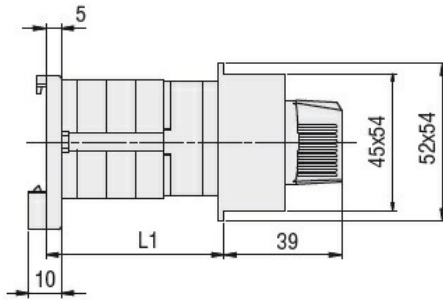

Series	L1		
	1	2	3
<b>7GN12</b>	38.1	47.8	57.5
<b>7GN20</b>	38.1	47.8	57.5
<b>7GN25</b>	42.5	56.1	69.7

**Wiring diagrams**

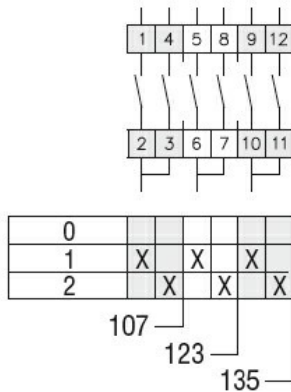

**Certifications and compliance**

Compliance

- CSA C22.2 n° 14
- IEC/EN/BS 60947-1
- IEC/EN/BS 60947-3
- IEC/EN/BS 60947-5-1
- UL60947-4-1

Certificates

- cCSAus
- EAC
- UL

**ETIM classification**

ETIM 8.0

EC001029 -  
Selector switch,  
complete