



General characteristics

Switching diagram	91 - ON/OFF switch 2 poles
N° of elements	1
Mounting form	O48 - Modular service cover for 35mm din rail mounting with black handle

Contact characteristics

Rated insulation voltage U_i	IEC/EN	V	690	
	UL/CSA	V	600	
Rated impulse withstand voltage U_{imp}		kV	6	
Conventional free air thermal current I_{th}	IEC/EN	A	25	
	UL/CSA	A	30	
Rated operational voltage		V	480	
Rated operational impulse voltage		kV	4	
Maximum fuse size for short-circuit protection I_n (gG)	10kA	A	25	
	15kA	A	25	
	25kA	A	25	
Rated short time current I_{cw}	1s	kA	400	
			10/5 mA/V	
Conductivity			10/5 mA/V	
Operational current I_e IEC/EN	AC1/AC21A	A	25	
	AC15			
	110V	A	16	
	220/230V	A	12	
	380/400V	A	8	
	660/690V	A	2	
Rated operational power in AC	Three-phase AC-3	220/230V	kW	5.5
		380/440V	kW	7.5
		500/690V	kW	7.5
	Single-phase AC-3	110V	kW	1.5
		220/230V	kW	3
		380/440V	kW	5.5
	Three-phase AC23A	220/230V	kW	6.5
		380/440V	kW	11

	500/690V	kW	11
Single-phase AC23A			
	110V	kW	1.5
	220/230V	kW	3.7
	380/440V	kW	5.5
Rated operational current in DC			
DC21A			
	48V	A	25
	60V	A	25
	110V	A	4
	220V	A	0.7
DC23A (poles in series)			
	24V	A	25 (1)
	48V	A	25 (2)
	60V	A	25 (3)
	110V	A	12 (3)
	220V	A	10 (4)
DC13			
	24V	A	25
	48V	A	20
	60V	A	16
	110V	A	1.5
	220V	A	0.4
Power dissipation		W	1.1
Mechanical features			
Terminals screw			M3.5
Tightening torque for terminals max		Nm	0.8
Conductor size			
AWG - Rigid cable			
	min	AWG	20
	Max	AWG	10
AWG - Flexible cable			
	min	AWG	20
	Max	AWG	12
Conductor size (IEC) - Flexible cable			
	min	mm ²	0.5
	Max	mm ²	4
Conductor size (IEC) - Rigid cable			
	min	mm ²	0.5
	Max	mm ²	4
Mechanical life		cycles	5x10 ⁶
UL technical data			
Motor power for direct-on-line control			
for three-phase motor			
	120V	HP	3
	240V	HP	5
	480V	HP	10
	600V	HP	15
for single-phase motor			
	120V	HP	1.5
	240V	HP	3

Ambient conditions

Temperature

Operating temperature

min	°C	-25
max	°C	+55

Storage temperature

min	°C	-40
max	°C	+70

Resistance & Protection

Frontal IP degree	IP40
Terminals IP degree	IP00

Dimensions

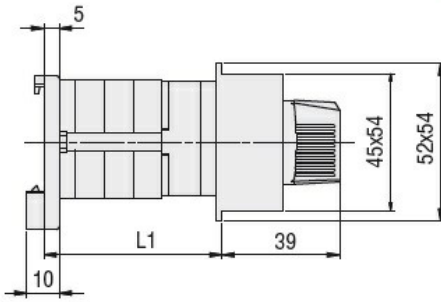

Series	L1		
	1	2	3
7GN12	38.1	47.8	57.5
7GN20	38.1	47.8	57.5
7GN25	42.5	56.1	69.7

Wiring diagrams

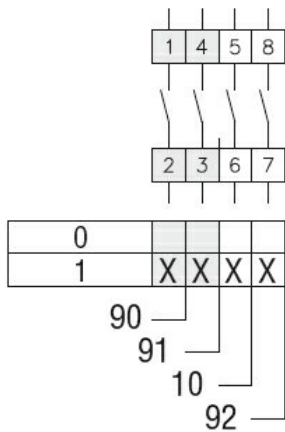

Certifications and compliance

Compliance

- CSA C22.2 n° 14
- IEC/EN/BS 60947-1
- IEC/EN/BS 60947-3
- IEC/EN/BS 60947-5-1
- UL60947-4-1

Certificates

- cCSAus
- EAC
- UL

ETIM classification

ETIM 8.0

EC001029 -
Selector switch,
complete