



General characteristics

Switching diagram	92 - ON/OFF switch 4 poles
N° of elements	2
Mounting form	U65 - Front mounting with red/yellow handle padlockable in 0 and protection covers

Contact characteristics

Rated insulation voltage U_i	IEC/EN	V	690
	UL/CSA	V	600
Rated impulse withstand voltage U_{imp}		kV	6
Conventional free air thermal current I_{th}	IEC/EN	A	25
	UL/CSA	A	30
Rated operational voltage		V	480
Rated operational impulse voltage		kV	4
Maximum fuse size for short-circuit protection I_n (gG)	10kA	A	25
	15kA	A	25
	25kA	A	25
Rated short time current I_{cw}	1s	kA	400
			10/5 mA/V
Conductivity			10/5 mA/V
Operational current I_e IEC/EN	AC1/AC21A	A	25
	AC15		
	110V	A	16
	220/230V	A	12
	380/400V	A	8
	660/690V	A	2
Rated operational power in AC	Three-phase AC-3		
	220/230V	kW	5.5
	380/440V	kW	7.5
	500/690V	kW	7.5
Single-phase AC-3			
	110V	kW	1.5
	220/230V	kW	3
	380/440V	kW	5.5
Three-phase AC23A			
	220/230V	kW	6.5

	380/440V	kW	11
	500/690V	kW	11
Single-phase AC23A			
	110V	kW	1.5
	220/230V	kW	3.7
	380/440V	kW	5.5
Rated operational current in DC			
DC21A			
	48V	A	25
	60V	A	25
	110V	A	4
	220V	A	0.7
DC23A (poles in series)			
	24V	A	25 (1)
	48V	A	25 (2)
	60V	A	25 (3)
	110V	A	12 (3)
	220V	A	10 (4)
DC13			
	24V	A	25
	48V	A	20
	60V	A	16
	110V	A	1.5
	220V	A	0.4
Power dissipation		W	1.1
Mechanical features			
Terminals screw			M3.5
Tightening torque for terminals max		Nm	0.8
Conductor size			
AWG - Rigid cable			
	min	AWG	20
	Max	AWG	10
AWG - Flexible cable			
	min	AWG	20
	Max	AWG	12
Conductor size (IEC) - Flexible cable			
	min	mm ²	0.5
	Max	mm ²	4
Conductor size (IEC) - Rigid cable			
	min	mm ²	0.5
	Max	mm ²	4
Mechanical life		cycles	5x10 ⁶
UL technical data			
Motor power for direct-on-line control			
for three-phase motor			
	120V	HP	3
	240V	HP	5
	480V	HP	10
	600V	HP	15
for single-phase motor			
	120V	HP	1.5
	240V	HP	3

Ambient conditions

Temperature

Operating temperature

min	°C	-25
max	°C	+55

Storage temperature

min	°C	-40
max	°C	+70

Resistance & Protection

Frontal IP degree IP40

Terminals IP degree IP00

Dimensions

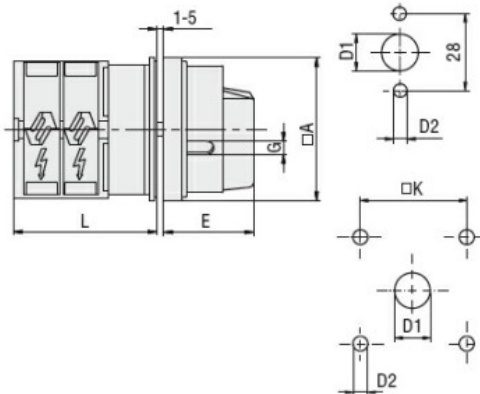

Series	Dimensions						L			
	□A	D1	D2	E	G	□K	1	2	3.....12	
7GN12	65	12	5	34.2	5	36	36.1	45.8	55.5	142.8
7GN20	65	12	5	34.2	5	36	36.1	45.8	55.5	142.8
7GN25	65	12	5	34.2	5	36	40.5	54.1	67.7	190.1
7GN32	65	14	5	38	6	48	46.5	61.6	76.7	212.6
7GN40	65	14	5	38	6	48	46.5	61.6	76.7	212.6
7GN63	65	14	5	38	6	48	50.3	68.4	86.5	249.4
7GN125	90	16	6	49	7	68	67.3	96.4	125.5	394.9

Wiring diagrams

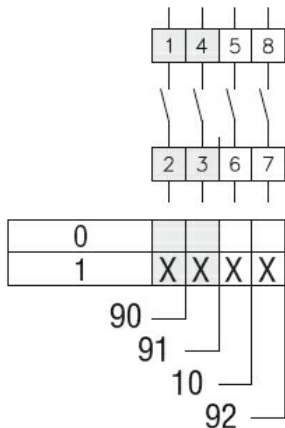

Certifications and compliance

Compliance

- CSA C22.2 n° 14
- IEC/EN/BS 60947-1
- IEC/EN/BS 60947-3
- IEC/EN/BS 60947-5-1
- UL60947-4-1

Certificates

- cCSAus
- EAC
- UL

ETIM classification

ETIM 8.0

EC001029 -
Selector switch,
complete