



General characteristics

Switching diagram	92 - ON/OFF switch 4 poles
N° of elements	2
Mounting form	U65 - Front mounting with red/yellow handle padlockable in 0 and protection covers

Contact characteristics

Rated insulation voltage U_i	IEC/EN	V	690	
	UL/CSA	V	600	
Rated impulse withstand voltage U_{imp}		kV	6	
Conventional free air thermal current I_{th}	IEC/EN	A	40	
	UL/CSA	A	50	
Rated operational voltage		V	480	
Rated operational impulse voltage		kV	4	
Maximum fuse size for short-circuit protection I_n (gG)	10kA	A	40	
	15kA	A	40	
	25kA	A	40	
	50kA	A	40	
	63kA	A	40	
Rated short time current I_{cw}	1s	kA	1000	
	60s	A	1000	
Conductivity			10/5 mA/V	
Operational current I_e IEC/EN	AC1/AC21A			
		A	40	
AC15	110V	A	25	
	220/230V	A	22	
	380/400V	A	12	
	660/690V	A	2	
Rated operational power in AC	Three-phase AC-3	220/230V	kW	8
		380/440V	kW	15
500/690V		kW	15	
Single-phase AC-3	110V	kW	3	
	220/230V	kW	6.5	

	380/440V	kW	8
Three-phase AC23A	220/230V	kW	8
	380/440V	kW	18.5
	500/690V	kW	22
Single-phase AC23A	110V	kW	3
	220/230V	kW	6
	380/440V	kW	11
Rated operational current in DC			
DC21A	48V	A	40
	60V	A	40
	110V	A	6
	220V	A	0.9
DC23A (poles in series)	24V	A	40 (1)
	48V	A	40 (2)
	60V	A	40 (3)
	110V	A	20 (3)
	220V	A	12 (4)
DC13	24V	A	40
	48V	A	32
	60V	A	16
	110V	A	3
Power dissipation		W	2.0
Mechanical features			
Terminals screw			M4
Tightening torque for terminals max		Nm	1.2
Conductor size			
AWG - Rigid cable			
	min	AWG	16
	Max	AWG	8
AWG - Flexible cable			
	min	AWG	16
	Max	AWG	10
Conductor size (IEC) - Flexible cable			
	min	mm ²	1.5
	Max	mm ²	6
Conductor size (IEC) - Rigid cable			
	min	mm ²	1.5
	Max	mm ²	10
Mechanical life		cycles	5x10 ⁶
UL technical data			
Motor power for direct-on-line control			
for three-phase motor			
	120V	HP	5
	240V	HP	10
	480V	HP	20
	600V	HP	20
for single-phase motor			
	120V	HP	2
	240V	HP	5

Ambient conditions

Temperature

Operating temperature

min	°C	-25
max	°C	+55

Storage temperature

min	°C	-40
max	°C	+70

Resistance & Protection

Frontal IP degree

IP40

Terminals IP degree

IP00

Dimensions

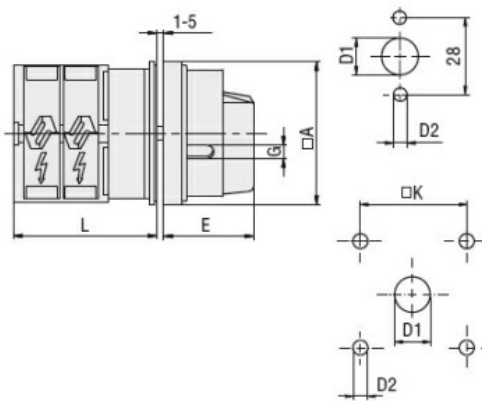

Series	Dimensions						L			
	□A	D1	D2	E	G	□K	1	2	3...12	
7GN12	65	12	5	34.2	5	36	36.1	45.8	55.5	142.8
7GN20	65	12	5	34.2	5	36	36.1	45.8	55.5	142.8
7GN25	65	12	5	34.2	5	36	40.5	54.1	67.7	190.1
7GN32	65	14	5	38	6	48	46.5	61.6	76.7	212.6
7GN40	65	14	5	38	6	48	46.5	61.6	76.7	212.6
7GN63	65	14	5	38	6	48	50.3	68.4	86.5	249.4
7GN125	90	16	6	49	7	68	67.3	96.4	125.5	394.9

Wiring diagrams

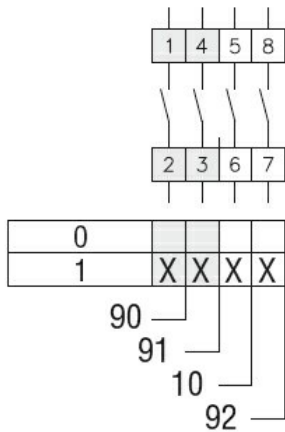

Certifications and compliance

Compliance

- CSA C22.2 n° 14
- IEC/EN/BS 60947-1
- IEC/EN/BS 60947-3
- IEC/EN/BS 60947-5-1
- UL60947-4-1

Certificates

- cCSAus
- EAC
- UL

ETIM classification

ETIM 8.0

EC001105 - Off-load switch