



General characteristics

Diameter	mm - inch	62 / 2.44
Colour		Black
Material		Plastic

Mechanical features

Weight	g	20
--------	---	----

Dimensions

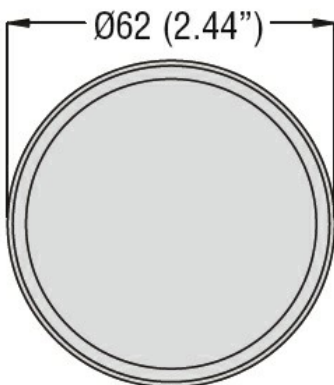
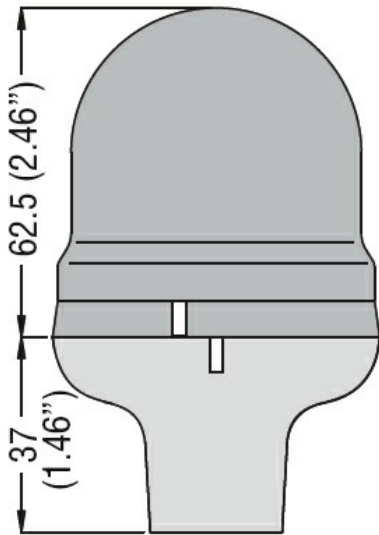

Certifications and compliance

Compliance

/

Certificates

/

ETIM classification

ETIM 8.0

EC001154 -
Stand for signal
tower without
tube