



General characteristics

Diameter	mm - inch	70 / 2.75
Colour		Grey
IEC degree of protection		IP65

Mechanical features

Tightening torque for terminals max	Nm	0.5
Terminals screw		Screw clamp terminals
Conductor section		
AWG/Kcmil	max	16
IEC	max	mm ² 1.5
Weight	g	110

Ambient conditions

Temperature	Operating temperature	min	°C	-20
		max	°C	+50

Dimensions

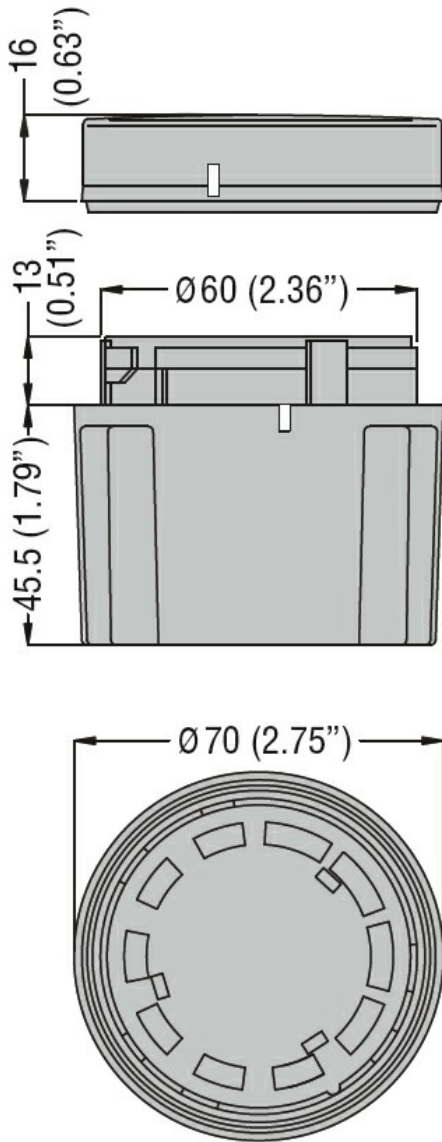

Wiring diagrams

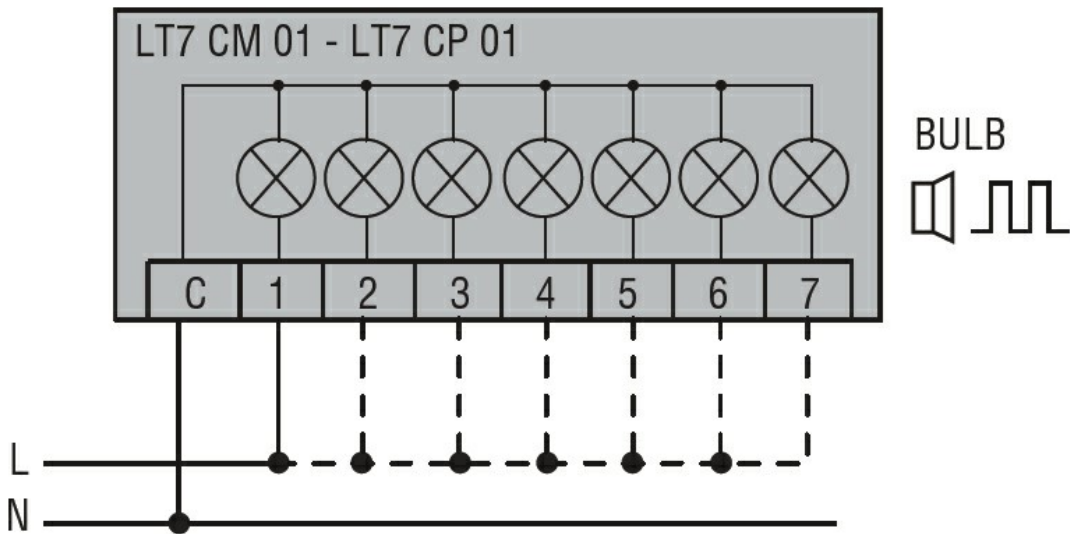

Connect terminals C and 1 as indicated to power the first module.
 If other modules are fitted, the respective terminals must be
 connected accordingly.

Certifications and compliance

Compliance

CSA C22.2 n°14

IEC/EN 60947-1

IEC/EN 60947-5-1

UL508

Certificates

cULus

EAC

ETIM classification

ETIM 8.0

EC001152 -
 Connection
 module for signal
 tower