



**General characteristics**

Diameter	mm - inch	70 / 2.75
Supply voltage (AC)	V	230...240
Colour		Red
IEC degree of protection		IP65
Light consumption per module (AC)	mA	15
Light consumption per module (DC)	mA	15
Sound module consumption (AC)	mA	15
Sound module consumption (DC)	mA	15

**Mechanical features**

Weight	g	92
--------	---	----

**Ambient conditions**

Temperature	Operating temperature	min	°C	-20
		max	°C	+50

**Dimensions**

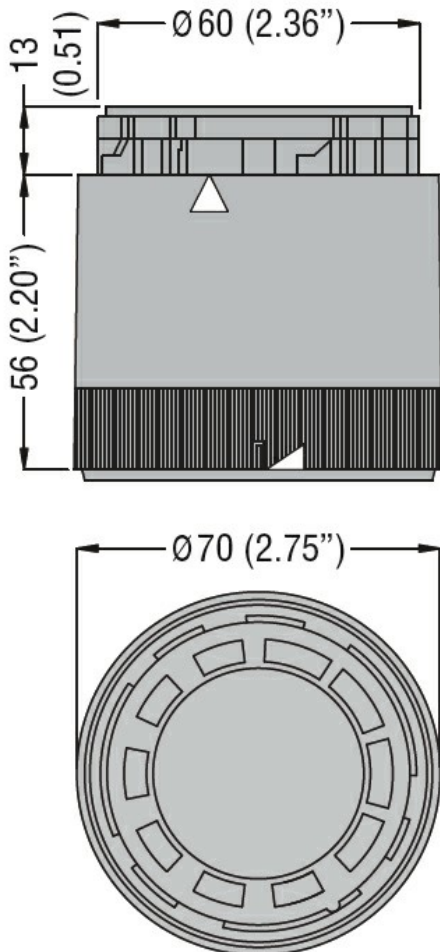

Wiring diagrams

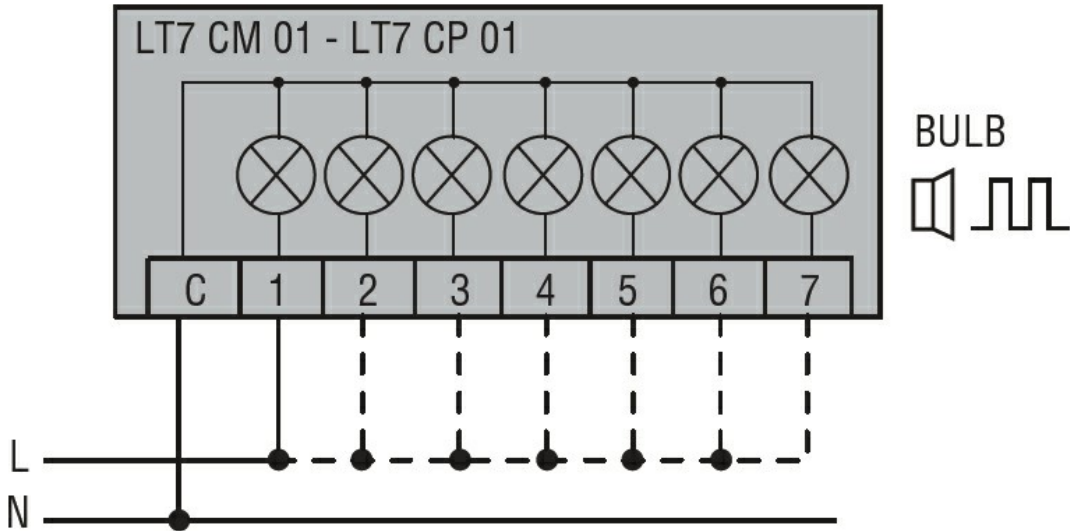

Connect terminals C and 1 as indicated to power the first module. If other modules are fitted, the respective terminals must be connected accordingly.

Certifications and compliance

Compliance

CSA C22.2 n° 14

IEC/EN 60947-1

IEC/EN 60947-5-1

UL508

Certificates

cULus

EAC

ETIM classification

ETIM 8.0

EC000232 -  
 Optical module  
 for signal tower