



Contact characteristics

Number of poles	Nr.	4
Rated insulation voltage U_i IEC/EN	V	1000
Rated impulse withstand voltage U_{imp}	kV	8
Operational frequency	min	Hz 25
	max	Hz 400
IEC Conventional free air thermal current $I_{th} \leq 40^\circ C$	A	165
Operational current I_e	AC-1 ($\leq 40^\circ C$)	A 165
	AC-1 ($\leq 55^\circ C$)	A 135
	AC-1 ($\leq 70^\circ C$)	A 118
	AC-3 ($\leq 440V \leq 55^\circ C$)	A 150
	AC-4 (400V)	A 70
Rated operational current AC-3 ($T \leq 55^\circ C$)	230V	A 150
	400V	A 150
	415V	A 150
	440V	A 150
	500V	A 128
	690V	A 113
	1000V	A 51
IEC max current I_e in DC1 with $L/R \leq 1ms$ with 1 poles in series	$\leq 24V$	A 165
	48V	A 165
	75V	A 150
	110V	A 10
	220V	A –
IEC max current I_e in DC1 with $L/R \leq 1ms$ with 2 poles in series	$\leq 24V$	A 165
	48V	A 165
	75V	A 165
	110V	A 150
	220V	A 14
IEC max current I_e in DC1 with $L/R \leq 1ms$ with 3 poles in series	$\leq 24V$	A 165
	48V	A 165
	75V	A 165
	110V	A 160
	220V	A 150
IEC max current I_e in DC1 with $L/R \leq 1ms$ with 4 poles in series	$\leq 24V$	A 165
	48V	A 165
	75V	A 165
	110V	A 165

	220V	A	165
IEC max current I _e in DC3-DC5 with L/R ≤ 15ms with 1 poles in series	≤24V	A	165
	48V	A	60
	75V	A	44
	110V	A	6
	220V	A	–
IEC max current I _e in DC3-DC5 with L/R ≤ 15ms with 2 poles in series	≤24V	A	165
	48V	A	82
	75V	A	70
	110V	A	80
	220V	A	7
IEC max current I _e in DC3-DC5 with L/R ≤ 15ms with 3 poles in series	≤24V	A	165
	48V	A	195
	75V	A	110
	110V	A	120
	220V	A	120
IEC max current I _e in DC3-DC5 with L/R ≤ 15ms with 4 poles in series	≤24V	A	165
	48V	A	130
	75V	A	130
	110V	A	150
	220V	A	150
Short-time allowable current for 10s (IEC/EN60947-1)		A	1200
Protection fuse	gG (IEC)	A	250
	aM (IEC)	A	160
Making capacity (RMS value)		A	1500
Breaking capacity at voltage	440V	A	1200
	500V	A	1025
	690V	A	905
Resistance per pole (average value)		mΩ	0.45
Power dissipation per pole (average value)	I _{th}	W	12
	AC-3	W	10.1
Tightening torque for terminals	min	Nm	6
	max	Nm	7
	min	I _{bin}	4.4
	max	I _{bin}	5.2
Tightening torque for coil terminal	min	Nm	0.8
	max	Nm	1
	min	I _{bin}	0.59
	max	I _{bin}	0.74
Conductor section	AWG/Kcmil		
	max		2/0
Flexible w/o lug conductor section	min	mm ²	1.5

	max	mm ²	70
Flexible c/w lug conductor section	min	mm ²	1.5
	max	mm ²	70
Power terminal protection according to IEC/EN 60529			IP20 front
Mechanical features			
Operating position	normal allowable		Vertical plan ±30°
Fixing			Screw / DIN rail 35mm
Weight		g	2420
Operations			
Mechanical life		cycles	15000000
Electrical life		cycles	800000
Safety related data			
Performance level B10d according to EN/ISO 13489-1	rated load mechanical load	cycles	800000
		cycles	15000000
EMC compatibility			yes
AC coil operating			
Rated AC voltage at 60Hz		V	24
AC operating voltage			
of 50/60Hz coil powered at 50Hz drop-out	max	%Us	55
of 60Hz coil powered at 60Hz pick-up	min	%Us	80
	max	%Us	110
drop-out	min	%Us	20
	max	%Us	55
AC average coil consumption at 20°C of 60Hz coil powered at 60Hz	in-rush holding	VA	300
		VA	20
Dissipation at holding ≤20°C 50Hz		W	6.5
Max cycles frequency			
Mechanical operation		cycles/h	1500
Operating times			
Average time for Us control in AC			
Closing NO	min	ms	45
	max	ms	32
Opening NO	min	ms	9
	max	ms	24
UL technical data			
Rated operational voltage AC (UL)		V	600
General USE			
Contactor	AC current	A	165

Short-circuit protection fuse, 600V
High fault

Short circuit current	kA	100
Fuse rating	A	200
Fuse class		J

Standard fault

Short circuit current	kA	10
Fuse rating	A	250
Fuse class		RK5

Ambient conditions

Temperature

Operating temperature

min	°C	-50
max	°C	70

Storage temperature

min	°C	-60
max	°C	80

Max altitude

m	3000
---	------

Dimensions

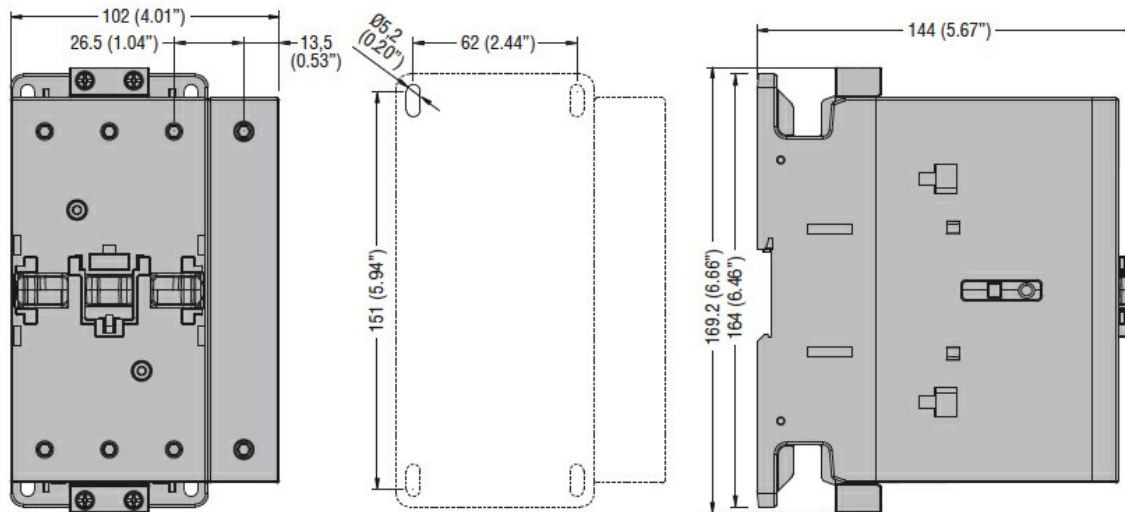

Wiring diagrams

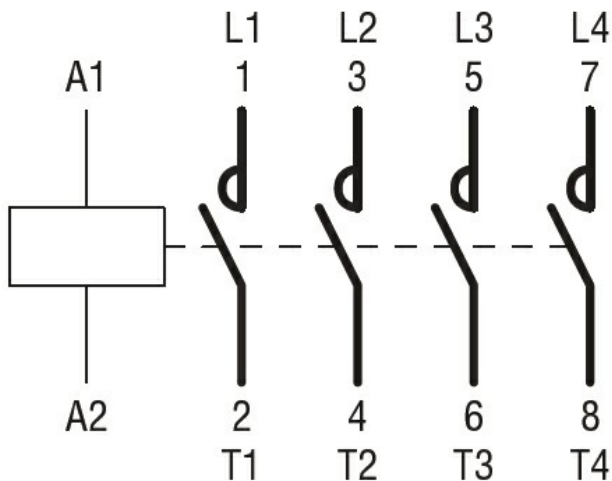

Certifications and compliance

Compliance

CSA C22.2 n° 60947-1

CSA C22.2 n° 60947-4-1

IEC/EN 60335-2-89

IEC/EN/BS 60947-1

IEC/EN/BS 60947-4-1

UL 60947-1

UL 60947-4-1

Certificates

CCC

CSA C22.2 n. 60335-2-40:22 LZGH A2L

CSA C22.2 No. 60335-2-89:21 LZGH A2L

cULus

EAC

UL 60335-2-40 LZGH A2L

UL 60335-2-89 LZGH A2L

ETIM classification

ETIM 8.0

EC000066 -
Power contactor,
AC switching