



Contact characteristics

Number of poles	Nr.	3
Rated insulation voltage U _i IEC/EN	V	690
Rated impulse withstand voltage U _{imp}	kV	6
Operational frequency	min	Hz 25
	max	Hz 400
IEC Conventional free air thermal current I _{th} ≤ 40°C	A	45
Operational current I _e	AC-1 (≤40°C)	A 45
	AC-1 (≤55°C)	A 36
	AC-1 (≤70°C)	A 32
	AC-3 (≤440V ≤55°C)	A 26
	AC-4 (400V)	A 11.5
Rated operational power AC-3 (T≤55°C)	230V	kW 7.3
	400V	kW 13
	415V	kW 14
	440V	kW 14
	500V	kW 15.6
	690V	kW 18.5
Rated operational power AC-1 (T≤40°C)	230V	kW 17
	400V	kW 30
	500V	kW 37
	690V	kW 51
IEC max current I _e in DC1 with L/R ≤ 1ms with 1 poles in series	≤24V	A 25
	48V	A 21
	75V	A 18
	110V	A 6
	220V	A –
IEC max current I _e in DC1 with L/R ≤ 1ms with 2 poles in series	≤24V	A 28
	48V	A 28
	75V	A 25
	110V	A 22
	220V	A 2
IEC max current I _e in DC1 with L/R ≤ 1ms with 3 poles in series	≤24V	A 28
	48V	A 28
	75V	A 25
	110V	A 24
	220V	A 20
IEC max current I _e in DC1 with L/R ≤ 1ms with 4 poles in series		

	≤24V	A	28
	48V	A	28
	75V	A	25
	110V	A	24
	220V	A	26
<hr/>			
IEC max current I _e in DC3-DC5 with L/R ≤ 15ms with 1 poles in series	≤24V	A	18
	48V	A	15
	75V	A	13
	110V	A	2
	220V	A	–
<hr/>			
IEC max current I _e in DC3-DC5 with L/R ≤ 15ms with 2 poles in series	≤24V	A	20
	48V	A	20
	75V	A	18
	110V	A	13
	220V	A	3
<hr/>			
IEC max current I _e in DC3-DC5 with L/R ≤ 15ms with 3 poles in series	≤24V	A	25
	48V	A	25
	75V	A	20
	110V	A	18
	220V	A	19
<hr/>			
IEC max current I _e in DC3-DC5 with L/R ≤ 15ms with 4 poles in series	≤24V	A	30
	48V	A	30
	75V	A	25
	110V	A	20
	220V	A	15
<hr/>			
Short-time allowable current for 10s (IEC/EN60947-1)		A	210
<hr/>			
Protection fuse	gG (IEC)	A	50
	aM (IEC)	A	32
<hr/>			
Making capacity (RMS value)		A	260
<hr/>			
Breaking capacity at voltage	440V	A	208
	500V	A	184
	690V	A	168
<hr/>			
Resistance per pole (average value)		mΩ	2
<hr/>			
Power dissipation per pole (average value)	I _{th}	W	4
	AC-3	W	1.4
<hr/>			
Tightening torque for terminals	min	Nm	2.5
	max	Nm	3
	min	I _{bin}	1.8
	max	I _{bin}	2.2
<hr/>			
Tightening torque for coil terminal	min	Nm	0.8
	max	Nm	1
	min	I _{bin}	0.8
	max	I _{bin}	0.74
<hr/>			
Max number of wires simultaneously connectable		Nr.	2

Conductor section			
AWG/Kcmil		max	6
Flexible w/o lug conductor section			
		min	mm ² 2.5
		max	mm ² 16
Flexible c/w lug conductor section			
		min	mm ² 1
		max	mm ² 10
Flexible with insulated spade lug conductor section			
		min	mm ² 1
		max	mm ² 16
Power terminal protection according to IEC/EN 60529			IP20 when properly wired
Cable stripping length			
	main circuit	mm	10
	command circuit	mm	8
Mechanical features			
Operating position			
	normal allowable		Vertical plan ±30°
Fixing			Screw / DIN rail 35mm
Weight			g 420
Operations			
Mechanical life			cycles 20000000
Electrical life			cycles 1600000
Safety related data			
Performance level B10d according to EN/ISO 13489-1			
	rated load	cycles	1600000
	mechanical load	cycles	20000000
EMC compatibility			yes
AC coil operating			
Rated AC voltage at 60Hz			V 48
AC operating voltage			
of 60Hz coil powered at 60Hz			
pick-up			
	min	%Us	80
	max	%Us	110
drop-out			
	min	%Us	20
	max	%Us	55
AC average coil consumption at 20°C			
of 60Hz coil powered at 60Hz			
	in-rush	VA	75
	holding	VA	9
Dissipation at holding ≤20°C 50Hz			W 2.5
Max cycles frequency			
Mechanical operation			cycles/h 3600
Operating times			
Average time for Us control in AC			
Closing NO			
	min	ms	8

Opening NO	max	ms	24
	min	ms	5
Closing NC	max	ms	15
	min	ms	9
Opening NC	max	ms	20
	min	ms	9
	max	ms	17

UL technical data

Rated operational voltage AC (UL) V 600

Full-load current (FLA) for three-phase AC motor

at 480V	A	21
at 600V	A	22

Yielded mechanical performance

for single-phase AC motor

110/120V	HP	2
230V	HP	5

for three-phase AC motor

200/208V	HP	7.5
220/240V	HP	7.5
460/480V	HP	15
575/600V	HP	20

General USE

Contactor

AC current	A	45
------------	---	----

Short-circuit protection fuse, 600V

High fault

Short circuit current	kA	100
Fuse rating	A	100
Fuse class		J

Standard fault

Short circuit current	kA	5
Fuse rating	A	100

Ambient conditions

Temperature

Operating temperature

min	°C	-50
max	°C	70

Storage temperature

min	°C	-60
max	°C	80

Max altitude

m	3000
---	------

Resistance & Protection

Pollution degree

3

Dimensions

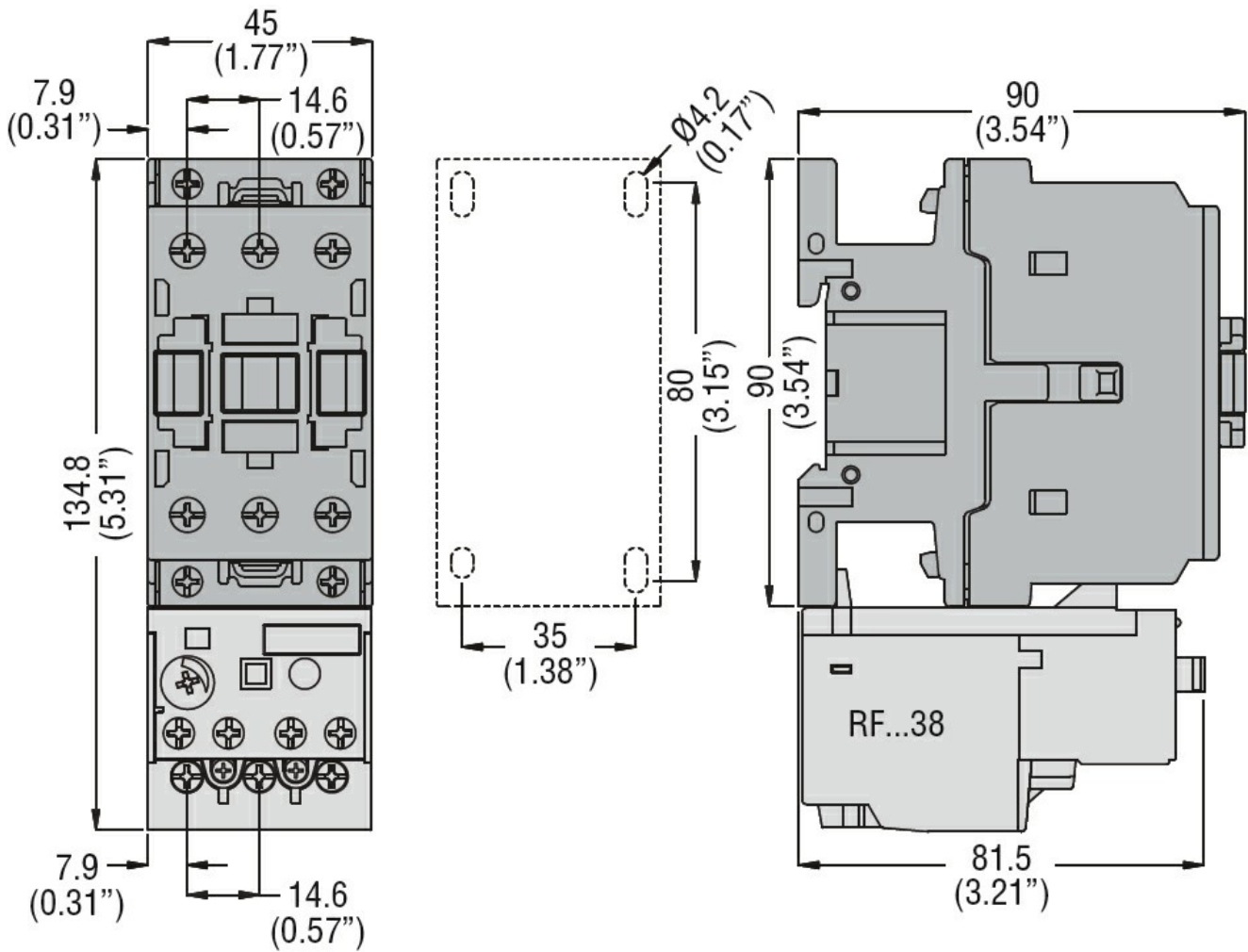

Wiring diagrams

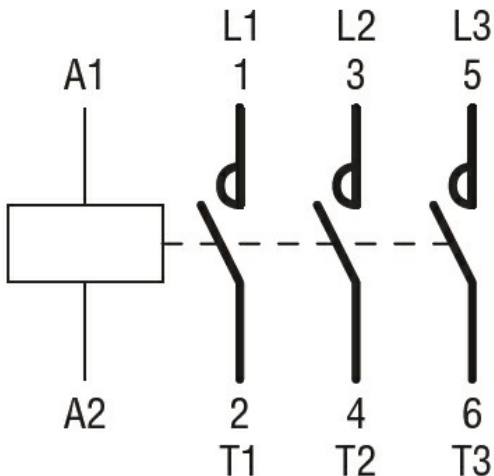

Certifications and compliance

Compliance

CSA C22.2 n° 60947-1

CSA C22.2 n° 60947-4-1

IEC/EN 60335-2-89

IEC/EN/BS 60947-1

IEC/EN/BS 60947-4-1

UL 60947-1

UL 60947-4-1

Certificates

CCC

CSA C22.2 n. 60335-2-40:22 LZGH A2L

CSA C22.2 No. 60335-2-89:21 LZGH A2L

cULus

EAC

UL 60335-2-40 LZGH A2L

UL 60335-2-89 LZGH A2L

ETIM classification

ETIM 8.0

EC000066 -
Power contactor,
AC switching