



Contact characteristics

Number of poles	Nr.	4
Rated insulation voltage U _i IEC/EN	V	690
Rated impulse withstand voltage U _{imp}	kV	6
Operational frequency	min	Hz 25
	max	Hz 400
IEC Conventional free air thermal current I _{th} ≤ 40°C	A	56
Operational current I _e	AC-1 (≤40°C)	A 56
	AC-1 (≤40°C) with 16mm ² wire and fork end lug	A 60
	AC-1 (≤55°C)	A 45
	AC-1 (≤55°C) with 16mm ² wire and fork end lug	A 48
	AC-1 (≤70°C)	A 40
	AC-1 (≤70°C) with 16mm ² wire and fork end lug	A 42
	AC-3 (≤440V ≤55°C)	A 38
Rated operational power AC-1 (T≤40°C)	AC-4 (400V)	A 15.5
	230V	kW 21
	400V	kW 36
	500V	kW 45
	690V	kW 62
Short-time allowable current for 10s (IEC/EN60947-1)	A	320
Protection fuse	gG (IEC)	A 63
	aM (IEC)	A 40
Making capacity (RMS value)	A	380
Breaking capacity at voltage	440V	A 304
	500V	A 240
	690V	A 192
Resistance per pole (average value)	mΩ	2
Power dissipation per pole (average value)	I _{th}	W 6
	AC-3	W 2.9
Tightening torque for terminals	min	Nm 2.5
	max	Nm 3
	min	lbin 1.8
	max	lbin 2.2
Tightening torque for coil terminal	min	Nm 0.8
	max	Nm 1
	min	lbin 0.8
	max	lbin 0.74

Max number of wires simultaneously connectable	Nr.	2	
Conductor section			
AWG/Kcmil		max	6
Flexible w/o lug conductor section		min	mm ² 2.5
		max	mm ² 16
Flexible c/w lug conductor section		min	mm ² 1
		max	mm ² 10
Flexible with insulated spade lug conductor section		min	mm ² 1
		max	mm ² 16
Power terminal protection according to IEC/EN 60529		IP20 when properly wired	
Cable stripping length			
	main circuit	mm	10
	command circuit	mm	8
Mechanical features			
Operating position		normal allowable	Vertical plan ±30°
Fixing			Screw / DIN rail 35mm
Weight		g	504
Operations			
Mechanical life		cycles	20000000
Electrical life		cycles	1400000
Safety related data			
Performance level B10d according to EN/ISO 13489-1			
	rated load	cycles	1400000
	mechanical load	cycles	20000000
EMC compatibility			yes
AC coil operating			
Rated AC voltage at 60Hz		V	230
AC operating voltage			
of 60Hz coil powered at 60Hz			
pick-up		min	%Us 80
		max	%Us 110
drop-out		min	%Us 20
		max	%Us 55
AC average coil consumption at 20°C			
of 60Hz coil powered at 60Hz			
	in-rush	VA	75
	holding	VA	9
Dissipation at holding ≤20°C 50Hz		W	2.5
Max cycles frequency			
Mechanical operation		cycles/h	3600
Operating times			
Average time for Us control			
in AC			

Closing NO	min	ms	8
	max	ms	24
Opening NO	min	ms	5
	max	ms	15
Closing NC	min	ms	11
	max	ms	29
Opening NC	min	ms	6
	max	ms	14

UL technical data

Rated operational voltage AC (UL) V 600

Full-load current (FLA) for three-phase AC motor

at 480V	A	40
at 600V	A	32

Yielded mechanical performance

for single-phase AC motor

110/120V	HP	3
230V	HP	7.5

for three-phase AC motor

200/208V	HP	10
220/240V	HP	15
460/480V	HP	30
575/600V	HP	30

General USE

Contactor

AC current	A	55
------------	---	----

Ambient conditions

Temperature

Operating temperature

min	°C	-50
max	°C	70

Storage temperature

min	°C	-60
max	°C	80

Max altitude

m	3000
---	------

Resistance & Protection

Pollution degree

3

Dimensions

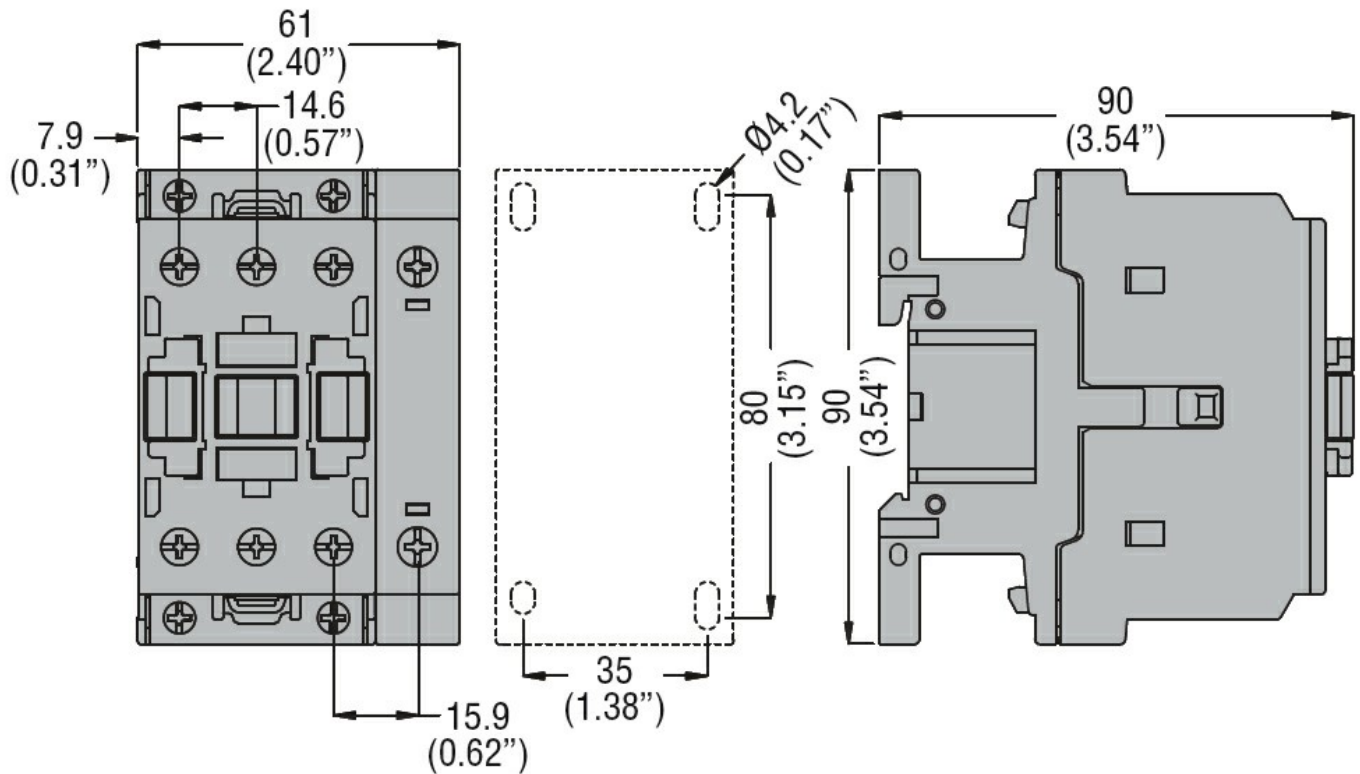

Wiring diagrams

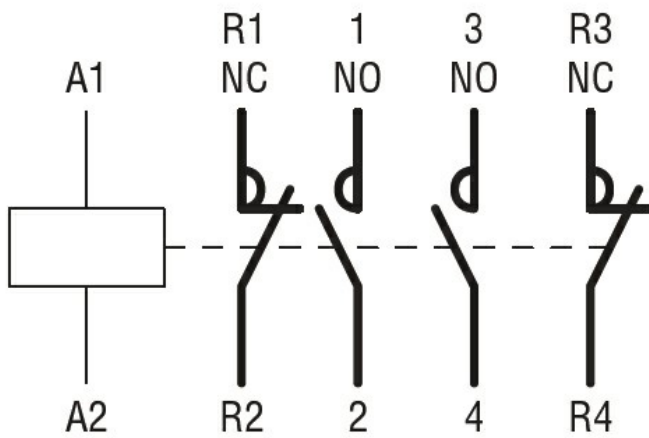

Certifications and compliance

Compliance

- CSA C22.2 n° 60947-1
- CSA C22.2 n° 60947-4-1
- IEC/EN 60335-2-89
- IEC/EN/BS 60947-1
- IEC/EN/BS 60947-4-1
- UL 60947-1
- UL 60947-4-1

Certificates

- CCC
- CSA C22.2 n. 60335-2-40:22 LZGH A2L
- CSA C22.2 No. 60335-2-89:21 LZGH A2L
- cULus
- EAC
- UL 60335-2-40 LZGH A2L

UL 60335-2-89 LZGH A2L

ETIM classification

ETIM 8.0

EC000066 -
Power contactor,
AC switching