



Electrical features

Maximum operating current ($\leq 440V$) A 60

Components

Contactor standard supplied BF3800A /
BF3800A /
BF2510A

Thermal relay standard supplied No

Thermal relay to purchase separately RF38

Auxiliary contact standard supplied BFX1020 /
BFX1011 /
BFX1011

Contact characteristics

IEC standard motor powers

	230V	kW	15
	400V	kW	30
	440V	kW	30
	500V	kW	30

Mechanical features

Weight g 1900

Dimensions

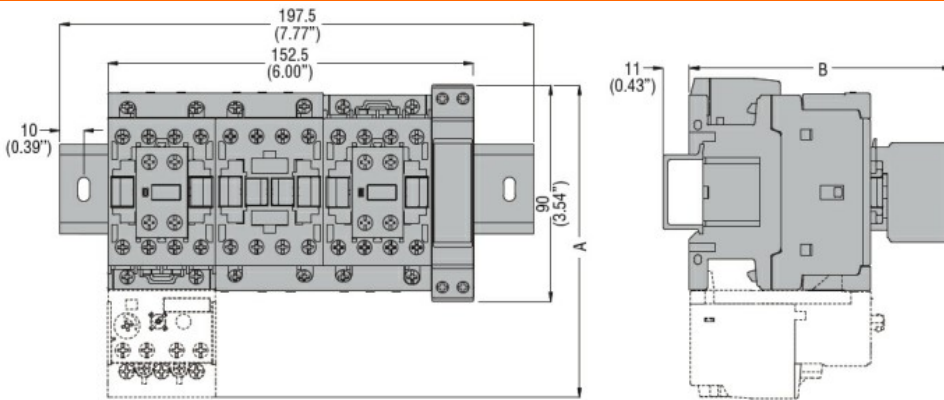

STARTER TYPE	A	B
BFA009 70	130.5 (5.14")	109.5 (4.31")
BFA012 70	130.5 (5.14")	109.5 (4.31")
BFA018 70	130.5 (5.14")	109.5 (4.31")
BFA025 70	130.5 (5.14")	109.5 (4.31")
BFA026 70	135 (5.14")	119 (4.68")
BFA032 70	135 (5.14")	119 (4.68")
BFA038 70	135 (5.14")	119 (4.68")
BFA050 70	173 (6.81")	142 (5.59")
BFA065 70	173 (6.81")	142 (5.59")
BFA080 70	183 (7.20")	142 (5.59")

Wiring diagrams

COMPLETA STAR-DELTA STARTER, OPEN FRAME, FOR STARTING TIME UP TO 12 SECONDS AND A MAXIMUM OF 30 OPERATIONS/HOUR, MAX IEC OPERATING CURRENT 60A. COIL VOLTAGE 400VAC 50/60HZ



Certifications and compliance

Compliance

IEC/EN 60947-1
IEC/EN 60947-4-9

Certificates

/

ETIM classification

ETIM 8.0

EC001037 -
Motor
starter/Motor
starter
combination