

Electrical features

Maximum operating current ($\leq 440V$)

A 140

Components

Contactor standard supplied

BF8000A /
BF8000A /
BF5000A

Thermal relay standard supplied

No

Thermal relay to purchase separately

RF82

Auxiliary contact standard supplied

BFX1020 /
BFX1011 /
BFX1011

Contact characteristics

IEC standard motor powers

230V	kW	45
400V	kW	75
440V	kW	75
500V	kW	90

Mechanical features

Weight

g 6265

Dimensions

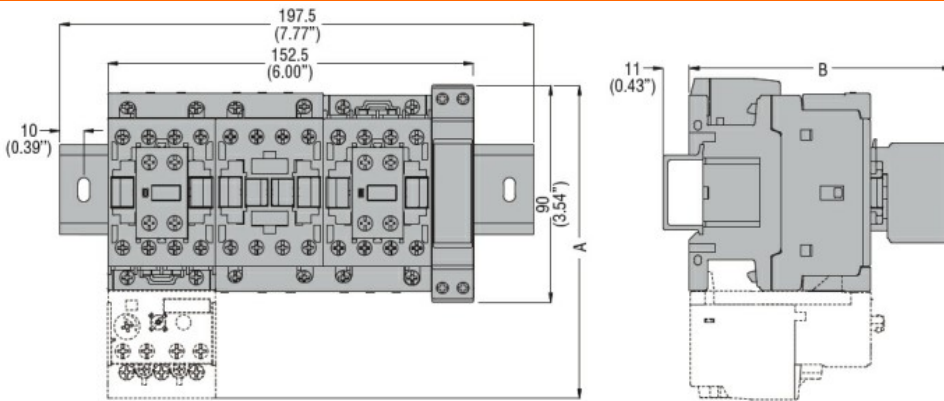

STARTER TYPE	A	B
BFA009 70	130.5 (5.14")	109.5 (4.31")
BFA012 70	130.5 (5.14")	109.5 (4.31")
BFA018 70	130.5 (5.14")	109.5 (4.31")
BFA025 70	130.5 (5.14")	109.5 (4.31")
BFA026 70	135 (5.14")	119 (4.68")
BFA032 70	135 (5.14")	119 (4.68")
BFA038 70	135 (5.14")	119 (4.68")
BFA050 70	173 (6.81")	142 (5.59")
BFA065 70	173 (6.81")	142 (5.59")
BFA080 70	183 (7.20")	142 (5.59")

Wiring diagrams

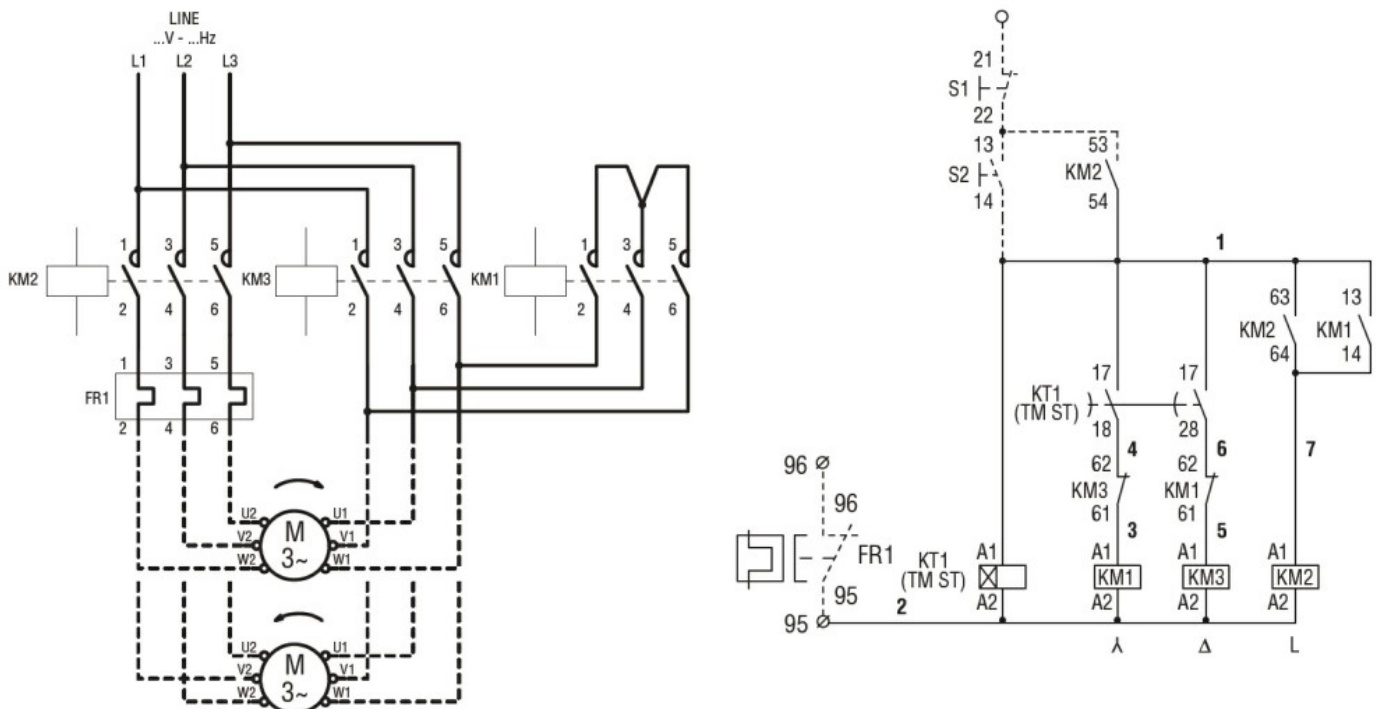

Certifications and compliance

Compliance

IEC/EN 60947-1

IEC/EN 60947-4-9

Certificates

/

ETIM classification

ETIM 8.0

EC001037 -
Motor
starter/Motor
starter
combination