



Electrical features

Maximum operating current ($\leq 440V$) A 195

Components

Contactor standard supplied	BF11500A / BF11500A / BF8000A
Thermal relay standard supplied	No
Thermal relay to purchase separately	RF200
Auxiliary contact standard supplied	BFX1020 / BFX1011 / BFX1011

Contact characteristics

IEC standard motor powers	230V	kW	55
	400V	kW	110
	440V	kW	110
	500V	kW	132

Mechanical features

Weight g 7500

Dimensions

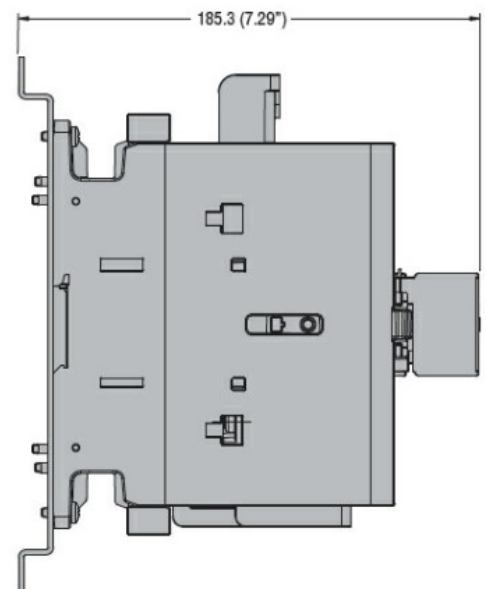
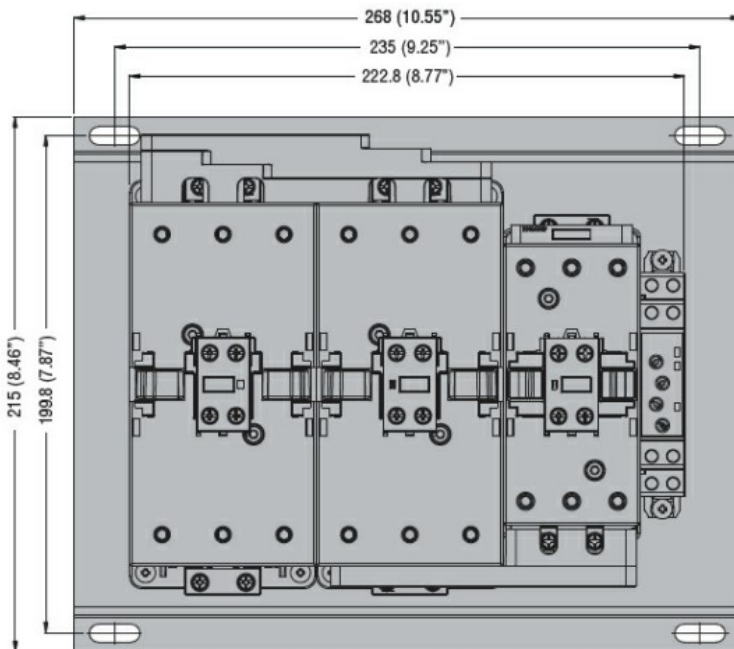

Wiring diagrams



Certifications and compliance

Compliance

IEC/EN 60947-1
IEC/EN 60947-4-1

Certificates

/

ETIM classification

ETIM 8.0

EC001037 -
Motor
starter/Motor
starter
combination