



Electrical features

Maximum operating current ($\leq 440V$) A 140

Contact characteristics

Operational current Ie

AC-1 ($\leq 40^\circ C$)	A	140
AC-1 ($\leq 55^\circ C$)	A	115
AC-1 ($\leq 60^\circ C$)	A	100

Mechanical features

Terminals type	Screw
Fixing	Side mount
Weight	g 4892

Dimensions

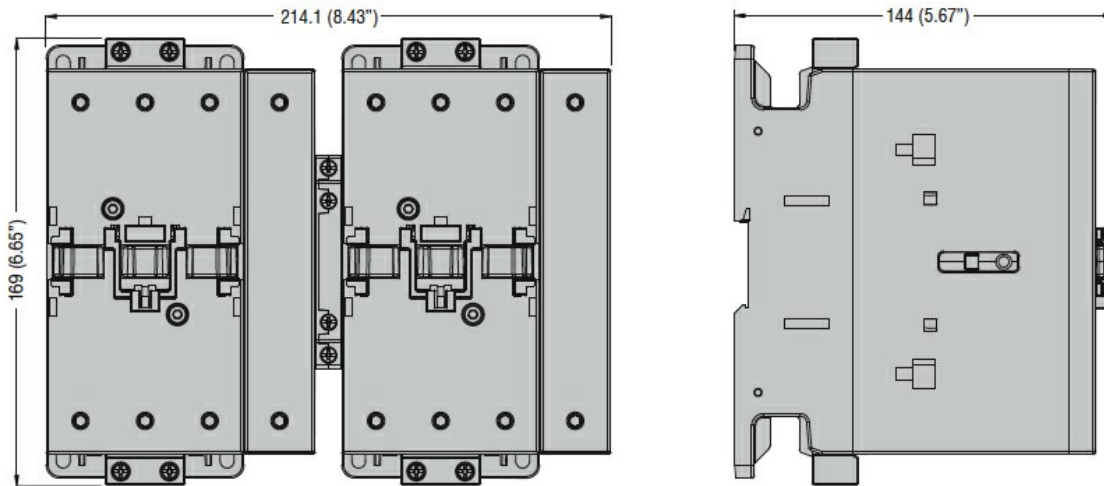

Wiring diagrams

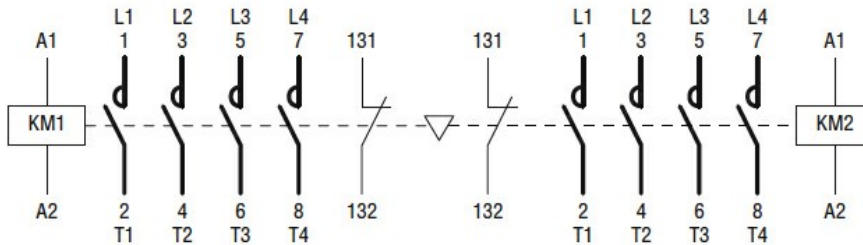

ETIM classification

ETIM 8.0

EC000010 -
Combination of
contactors