



### General characteristics

Description	4 static outputs, opto-isolated	
Functions	Inputs and outputs	
Compatibility with LOVATO Electric product		
Digital multimeters	DMG600/601/611	Yes
Digital power analyzers	DMG7000	Yes
	DMG7500	Yes
	DMG8000	Yes
	DMG9000	Yes
Automatic power factor controllers	DCRG8	Yes
Automatic transfer switch contrllers	ATL610	Yes
	ATL800/900	Yes
Fire pump controllers	FFLRA400	Yes
Engine and generator controllers	RGK750/RGK8/RGK9	Yes

### Input and Output

#### Analog outputs

Number of analog output	Nr.	
	4	

### Mechanical features

#### Weight

g	54
---	----

### Dimensions

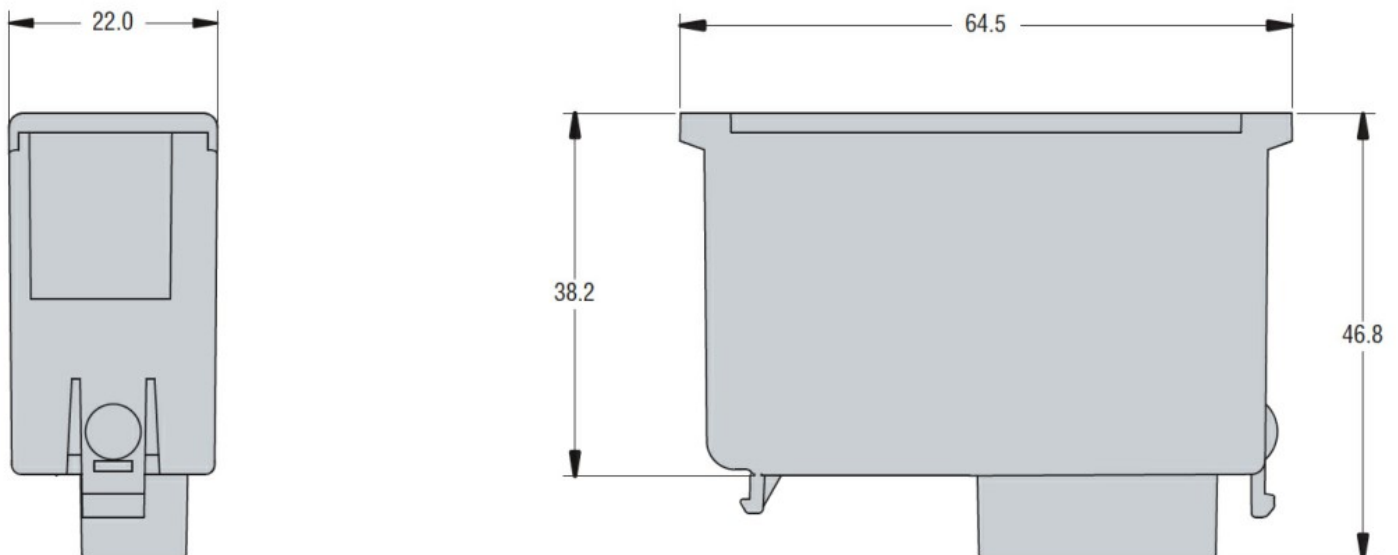

### Wiring diagrams

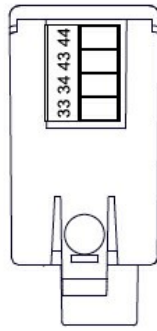
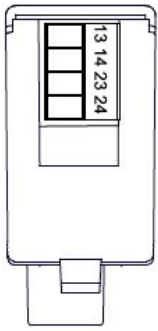

OUT 1

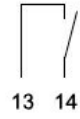

OUT 2

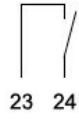

OUT 3

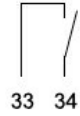

OUT 4

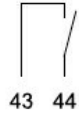

### Certifications and compliance

#### Compliance

CSA C22.2 n° 14

IEC/EN 61000-6-2

IEC/EN 61000-6-3

IEC/EN 61010-1

UL508

#### Certificates

cULus

EAC

### ETIM classification

ETIM 8.0

EC002498 -  
Accessories/spare  
parts for low-  
voltage switch  
technology