



**General characteristics**

Description	2 digital inputs and 2 static outputs, opto-isolated		
Functions	Inputs and outputs		
Compatibility with LOVATO Electric product			
Digital multimeters	DMG600/601/611		Yes
Digital power analyzers	DMG7000		Yes
	DMG7500		Yes
	DMG8000		Yes
	DMG9000		Yes
Automatic power factor controllers	DCRG8		Yes
Automatic transfer switch contrllers	ATL610		Yes
	ATL800/900		Yes
Fire pump controllers	FFLRA400		Yes
Engine and generator controllers	RGK750/RGK8/RGK9		Yes

**Input and Output**

Digital inputs	Number of digital input	Nr.	2
Analog outputs	Number of analog output	Nr.	2

**Mechanical features**

Weight	g	58
--------	---	----

**Dimensions**

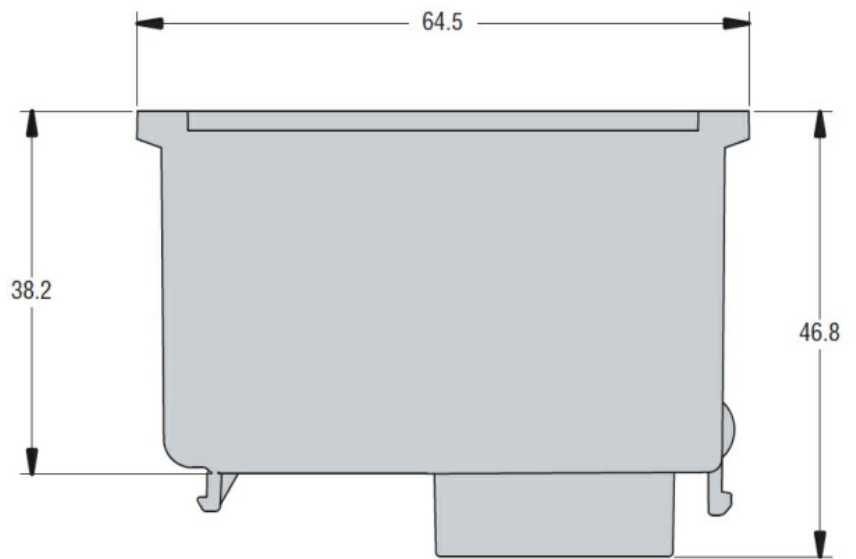
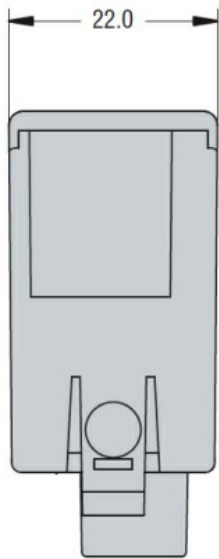

**Wiring diagrams**

Disposizione morsetti degli ingressi digitali  
Terminal arrangement of digital inputs

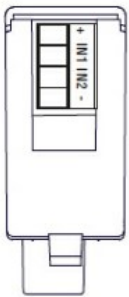

Ingresso da sensori alimentati (vedi note sotto)  
Supplied sensor inputs (See note below)

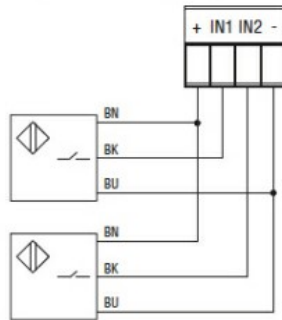

Ingressi da contatto non tensionato  
Free voltage contact inputs

Connessione PNP  
PNP connection

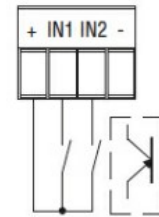

Connessione NPN  
NPN connection

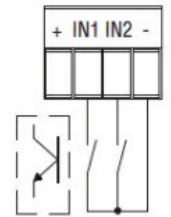

Disposizione morsetti delle uscite (statiche o relè)  
Terminal arrangement of outputs (static or relay)

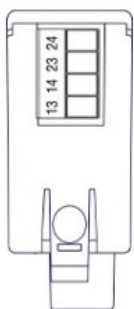

Connessione uscite  
Output connections

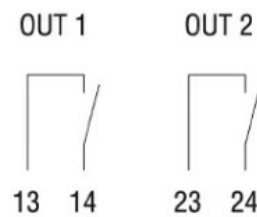

**Certifications and compliance**

**Compliance**

CSA C22.2 n° 14  
IEC/EN 61000-6-2  
IEC/EN 61000-6-3  
IEC/EN 61010-1  
UL508

**Certificates**

cULus

---

EAC

ETIM classification

ETIM 8.0

EC002498 -  
Accessories/spare  
parts for low-  
voltage switch  
technology