



General characteristics

Description	3 relay outputs to increase number of steps		
Functions	Inputs and outputs		
Compatibility with LOVATO Electric product			
Automatic power factor controllers	DCRL3/5	Yes	
	DCRG8	Yes	
Automatic transfer switch controllers	ATL610	Yes	

Input and Output

Digital outputs	Number of digital output	Nr.	3
-----------------	--------------------------	-----	---

Mechanical features

Weight	g	85
--------	---	----

Dimensions

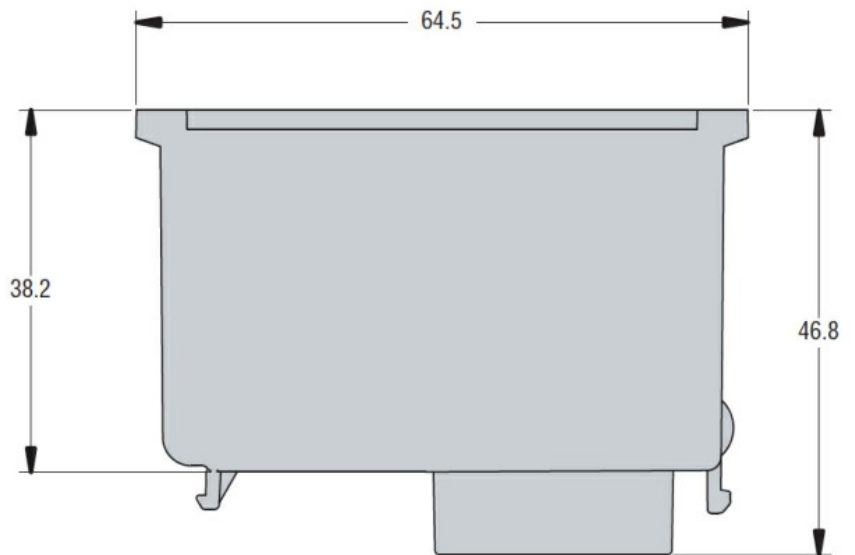
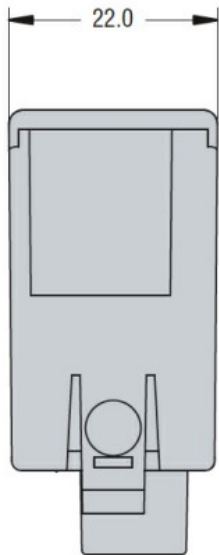

Wiring diagrams

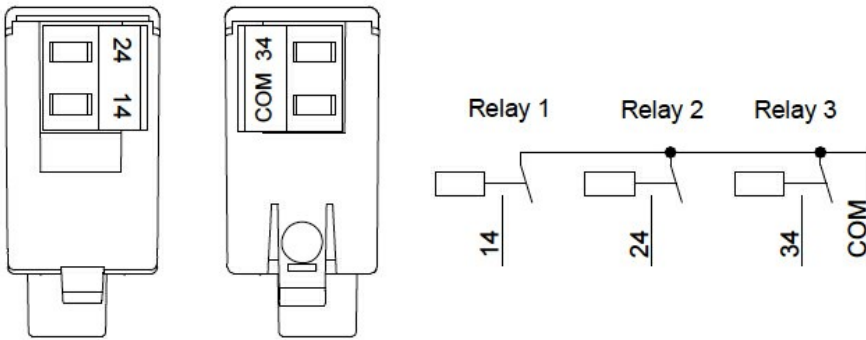

Certifications and compliance

Compliance

CSA C22.2 n° 14

IEC/EN 61000-6-2

IEC/EN 61000-6-3

IEC/EN 61010-1

UL508

Certificates

cULus

EAC

ETIM classification

ETIM 8.0

EC002498 -
Accessories/spare
parts for low-
voltage switch
technology