

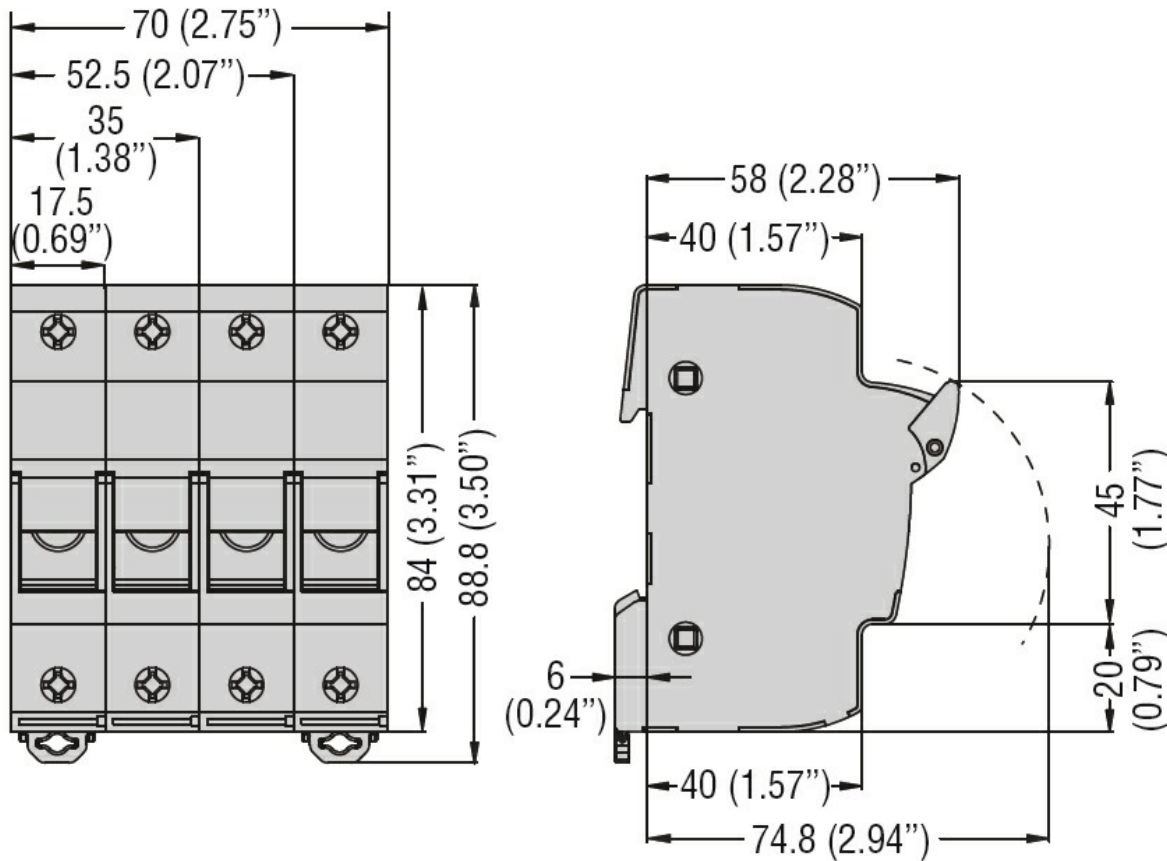

Electrical features			
IEC maximum rated current (In)	A	30	
IEC maximum rated voltage (Un)	V	600	
IEC Utilization category		AC22B 500V - AC21B 690V	
Power dissipation Max	W	3	
Derating factor of rated current In for different ambient temperature	20°C	1	
	30°C	0.95	
	40°C	0.9	
	50°C	0.8	
	60°C	0.7	
	70°C	0.5	
Derating factor of rated current In for side by side fuse holders (poles)	1-4	1	
	5-6	0.8	
	7-9	0.7	
	≥10	0.6	
	Rated current (In)	A	30
Ambient conditions			
Operating temperature	min	°C	-20
	max	°C	+70
Storage temperature	min	°C	-40
	max	°C	+80
Max altitude	m	3000	
Mechanical features			
Operating position	normal allowable	Vertical plan	
		Any	
Fixing		35mm DIN rail	
Tightening torque for terminals	max	Nm	2.5
	max	lbin	22
Conductor section	Flexible max (IEC)	mm ²	16
	- Flexible max (AWG/kcmil)		8
	Rigid max (IEC)	mm ²	16
	- Rigid max (AWG/kcmil)		8
Weight	g	7	
Resistance & Protection			
Frontal IP degree		IP20	
Dimensions			



Wiring diagrams



Certifications and compliance

Compliance

CSA C22.2 n°4248.1

CSA C22.2 n°4248.4.

IEC/EN 60269-1

IEC/EN 60269-2

IEC/EN 60947-1

IEC/EN 60947-3

UL 4248-1

UL 4248-4

Certifications

EAC

UL

ETIM classification

ETIM 8.0

EC002705 -
Holder for
cylindrical fuse