

General characteristics

Switching diagram	07 - ON/OFF switch 3 poles
N° of elements	2
Mounting form	O48 - Modular service cover for 35mm din rail mounting with black handle

Contact characteristics

Rated insulation voltage U_i	IEC/EN	V	480
	UL/CSA	V	240
Rated impulse withstand voltage U_{imp}		kV	4
Conventional free air thermal current I_{th}	IEC/EN	A	20
	UL/CSA	A	15
Rated operational voltage		V	480
Rated operational impulse voltage		kV	4
Maximum fuse size for short-circuit protection I_n (gG)	10kA	A	20
	15kA	A	20
	25kA	A	20
Rated short time current I_{cw}	1s	kA	250
			10/5 mA/V
Conductivity			10/5 mA/V
Operational current I_e IEC/EN	AC1/AC21A	A	20
	AC15		
	110V	A	10
	220/230V	A	8
	380/400V	A	6
Rated operational power in AC	Three-phase AC-3		
		220/230V	kW
	380/440V	kW	5
Single-phase AC-3	110V	kW	0.5
	220/230V	kW	1.5
	380/440V	kW	2
Three-phase AC23A	220/230V	kW	4
	380/440V	kW	7.5
Single-phase AC23A	110V	kW	0.75
	220/230V	kW	2
	380/440V	kW	2.5
Rated operational current in DC	DC21A		
	48V	A	20
	60V	A	20
	110V	A	4

		220V	A	0.7
		440V	A	0.2
DC13		24V	A	6
		48V	A	6
		60V	A	3
		110V	A	1
		220V	A	0.4
		440V	A	0.15
Power dissipation			W	0.8
Mechanical features				
Terminals screw				M3
Tightening torque for terminals max			Nm	0.5
Conductor size				
	AWG - Rigid cable			
		min	AWG	20
		Max	AWG	12
	AWG - Flexible cable			
		min	AWG	20
		Max	AWG	12
	Conductor size (IEC) - Flexible cable			
		min	mm ²	0.5
		Max	mm ²	2.5
	Conductor size (IEC) - Rigid cable			
		min	mm ²	0.5
		Max	mm ²	2.5
Mechanical life			cycles	1x10 ⁶
UL technical data				
Motor power for direct-on-line control				
	for three-phase motor			
		240V	HP	3
	for single-phase motor			
		240V	HP	1
Ambient conditions				
Temperature				
	Operating temperature			
		min	°C	-25
		max	°C	+55
	Storage temperature			
		min	°C	-40
		max	°C	+70
Resistance & Protection				
Frontal IP degree				IP40
Terminals IP degree				IP20
Dimensions				

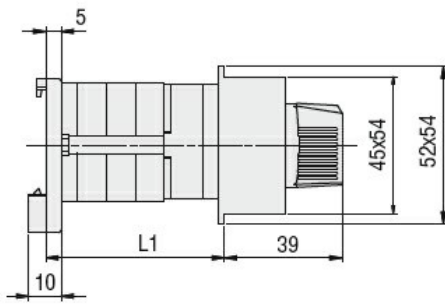

Series	L1		
	1	2	3
GF20	40	53.5	67

Wiring diagrams

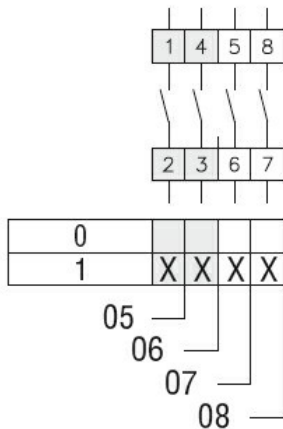

Certifications and compliance

Compliance

- CSA C22.2 n° 14
- IEC/EN/BS 60947-1
- IEC/EN/BS 60947-3
- IEC/EN/BS 60947-5-1
- UL60947-4-1

Certificates

- cULus
- EAC

ETIM classification

ETIM 8.0

EC001029 -
Selector switch,
complete