

General characteristics

Switching diagram	55 - Changeover switch without 0 2 poles
N° of elements	2
Mounting form	O48 - Modular service cover for 35mm din rail mounting with black handle

Contact characteristics

Rated insulation voltage U_i	IEC/EN	V	480			
	UL/CSA	V	240			
Rated impulse withstand voltage U_{imp}		kV	4			
Conventional free air thermal current I_{th}	IEC/EN	A	20			
	UL/CSA	A	15			
Rated operational voltage		V	480			
Rated operational impulse voltage		kV	4			
Maximum fuse size for short-circuit protection I_n (gG)	10kA	A	20			
	15kA	A	20			
	25kA	A	20			
Rated short time current I_{cw}	1s	kA	250			
	Conductivity			10/5 mA/V		
Operational current I_e IEC/EN	AC1/AC21A		A	20		
	AC15		110V	A	10	
			220/230V	A	8	
			380/400V	A	6	
Rated operational power in AC	Three-phase AC-3		220/230V	kW	3	
			380/440V	kW	5	
	Single-phase AC-3		110V	kW	0.5	
			220/230V	kW	1.5	
			380/440V	kW	2	
	Three-phase AC23A		220/230V	kW	4	
			380/440V	kW	7.5	
	Single-phase AC23A		110V	kW	0.75	
			220/230V	kW	2	
			380/440V	kW	2.5	
	Rated operational current in DC	DC21A		48V	A	20
				60V	A	20
		110V	A	4		

		220V	A	0.7
		440V	A	0.2
DC13		24V	A	6
		48V	A	6
		60V	A	3
		110V	A	1
		220V	A	0.4
		440V	A	0.15
Power dissipation			W	0.8
Mechanical features				
Terminals screw				M3
Tightening torque for terminals max			Nm	0.5
Conductor size				
	AWG - Rigid cable			
		min	AWG	20
		Max	AWG	12
	AWG - Flexible cable			
		min	AWG	20
		Max	AWG	12
	Conductor size (IEC) - Flexible cable			
		min	mm ²	0.5
		Max	mm ²	2.5
	Conductor size (IEC) - Rigid cable			
		min	mm ²	0.5
		Max	mm ²	2.5
Mechanical life			cycles	1x10 ⁶
UL technical data				
Motor power for direct-on-line control				
	for three-phase motor			
		240V	HP	3
	for single-phase motor			
		240V	HP	1
Ambient conditions				
Temperature				
	Operating temperature			
		min	°C	-25
		max	°C	+55
	Storage temperature			
		min	°C	-40
		max	°C	+70
Resistance & Protection				
Frontal IP degree				IP40
Terminals IP degree				IP20
Dimensions				

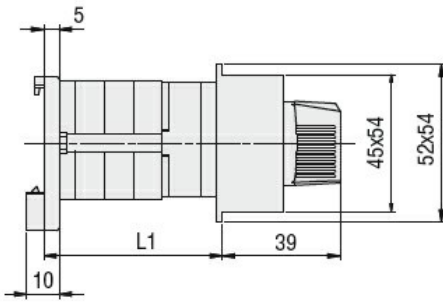

Series	L1		
	1	2	3
GF20	40	53.5	67

Wiring diagrams

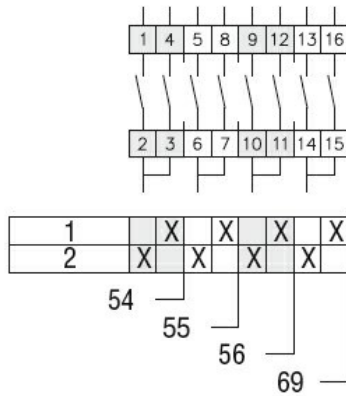

Certifications and compliance

Compliance

CSA C22.2 n° 14
IEC/EN/BS 60947-1
IEC/EN/BS 60947-3
IEC/EN/BS 60947-5-1
UL60947-4-1

Certificates

cULus
EAC

ETIM classification

ETIM 8.0

EC001029 -
Selector switch,
complete