

General characteristics

Switching diagram	82 - Multi-step 1-2-3 1 pole
N° of elements	2
Mounting form	U - Front mounting with black handle

Contact characteristics

Rated insulation voltage U_i	IEC/EN	V	690
	UL/CSA	V	600
Rated impulse withstand voltage U_{imp}		kV	8
Conventional free air thermal current I_{th}	IEC/EN	A	315
	UL/CSA	A	255
Rated operational voltage		V	690
Rated operational impulse voltage		kV	6
Maximum fuse size for short-circuit protection I_n (gG)	10kA	A	315
	15kA	A	315
Rated short time current I_{cw}	1s	kA	5200
Operational current I_e IEC/EN AC1/AC21A		A	315
Rated operational power in AC Three-phase AC-3	220/230V	kW	37
	380/440V	kW	55
	500/690V	kW	69
	Single-phase AC-3		
	110V	kW	11
	220/230V	kW	22
	380/440V	kW	30
Rated operational current in DC DC21A	48V	A	200
	60V	A	200
	110V	A	35
	220V	A	2.5
	440V	A	0.9
Power dissipation		W	64.5

Mechanical features

Terminals screw	M10		
Tightening torque for terminals max	Nm 10		
Conductor size AWG - Rigid cable	Max	AWG	1XMCM350
AWG - Flexible cable	Max	AWG	1XMCM350
Conductor size (IEC) - Flexible cable	Max	mm ²	1X185
Conductor size (IEC) - Rigid cable			

Mechanical life	Max	mm ²	1X185
		cycles	2X10 ⁵

UL technical data

Motor power for direct-on-line control for three-phase motor	120V	HP	30
	240V	HP	50
	480V	HP	100
	600V	HP	75
for single-phase motor	120V	HP	15
	240V	HP	30

Ambient conditions

Temperature	Operating temperature	min	°C	-25
		max	°C	+55
	Storage temperature	min	°C	-40
		max	°C	+70

Resistance & Protection

Frontal IP degree	IP40
Terminals IP degree	IP00

Dimensions

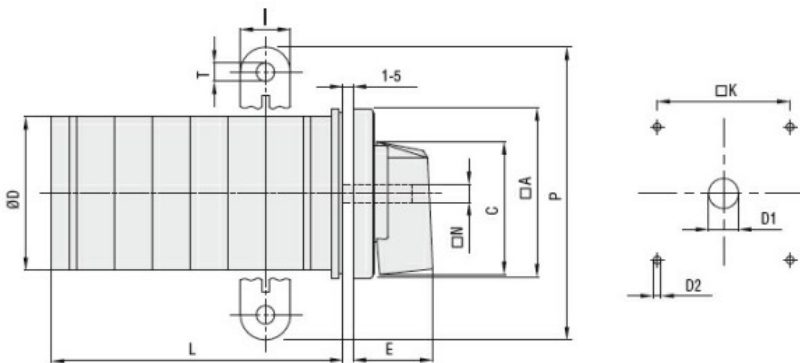

Series	Dimensions										L Number of elements ①												
	□A	C	ØD	ØD1	ØD2	E	I	□K	□N	P	ØT	1	2	3	4	5	6	7	8	9	10	11	12
GN200	132	104	120	16	5.3	56	20	104	10	140	10.5	77	107	136	166	196	226	284	314	343	373	402	432
GN315	132	104	120	16	5.3	56	20	104	10	145	10.5	77	107	136	166	196	226	284	314	343	373	402	432

① For devices with 6 or more elements please consult Technical support, see contact details on inside front cover.

Wiring diagrams

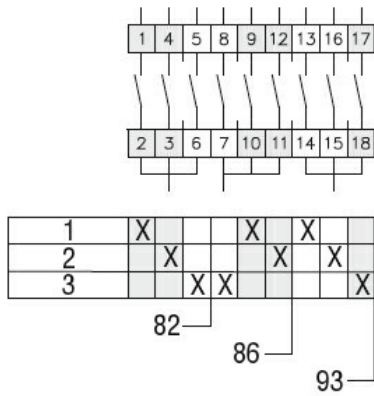

Certifications and compliance

Compliance

IEC/EN/BS 60947-1

IEC/EN/BS 60947-3

IEC/EN/BS 60947-5-1

UL60947-4-1

Certificates

UR

ETIM classification

ETIM 8.0

EC001029 -
Selector switch,
complete