



General characteristics

Switching diagram	91 - ON/OFF switch 2 poles
N° of elements	1
Mounting form	U11 - Front mounting with black handle without front plate for hole diam. 22mm fixing

Contact characteristics

Rated insulation voltage U_i	IEC/EN	V	690
	UL/CSA	V	600
Rated impulse withstand voltage U_{imp}		kV	6
Conventional free air thermal current I_{th}	IEC/EN	A	16
	UL/CSA	A	12
Rated operational voltage		V	440
Rated operational impulse voltage		kV	4
Maximum fuse size for short-circuit protection I_n (gG)	10kA	A	16
	15kA	A	16
	25kA	A	16
Rated short time current I_{cw}	1s	kA	250
			10/5 mA/V
Conductivity			10/5 mA/V
Operational current I_e IEC/EN	AC1/AC21A	A	16
	AC15		
	110V	A	10
	220/230V	A	8
	380/400V	A	4
	660/690V	A	1.5
Rated operational power in AC	Three-phase AC-3		
	220/230V	kW	3.5
	380/440V	kW	4.5
	500/690V	kW	5.5
Single-phase AC-3			
	110V	kW	0.55
	220/230V	kW	1.5
	380/440V	kW	2.2
Three-phase AC23A			
	220/230V	kW	3.7

	380/440V	kW	6.5
	500/690V	kW	7.5
Single-phase AC23A			
	110V	kW	0.75
	220/230V	kW	1.8
	380/440V	kW	3
Rated operational current in DC			
DC21A			
	48V	A	16
	60V	A	16
	110V	A	4
	220V	A	0.6
	440V	A	0.25
DC23A (poles in series)			
	24V	A	16 (1)
	48V	A	16 (2)
	60V	A	16 (3)
	110V	A	10 (3)
	220V	A	7 (4)
DC13			
	24V	A	16
	48V	A	14
	60V	A	10
	110V	A	1
	220V	A	0.4
	440V	A	0.15
Power dissipation		W	0.6
Mechanical features			
Terminals screw			3M
Tightening torque for terminals max		Nm	0.5
Conductor size			
AWG - Rigid cable			
	min	AWG	20
	Max	AWG	12
AWG - Flexible cable			
	min	AWG	20
	Max	AWG	12
Conductor size (IEC) - Flexible cable			
	min	mm ²	0.5
	Max	mm ²	2.5
Conductor size (IEC) - Rigid cable			
	min	mm ²	0.5
	Max	mm ²	2.5
Mechanical life		cycles	1X10 ⁶
UL technical data			
Motor power for direct-on-line control			
for three-phase motor			
	120V	HP	1.5
	240V	HP	3
	480V	HP	5
	600V	HP	5
for single-phase motor			
	120V	HP	0.75
	240V	HP	1

Ambient conditions

Temperature

Operating temperature

min	°C	-25
max	°C	+55

Storage temperature

min	°C	-40
max	°C	+70

Resistance & Protection

Frontal IP degree	IP65
Terminals IP degree	IP20

Dimensions

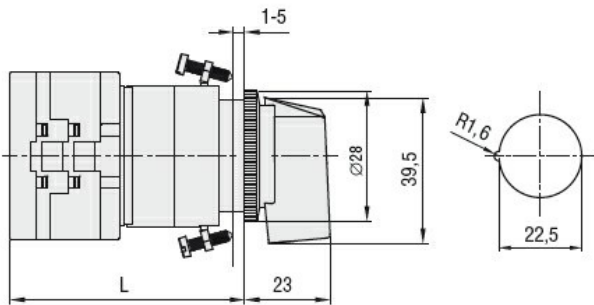

Series	L			
	1	2	3...8	
GX16	54	62.5	71	147.5
GX20	54	62.5	71	147.5

Wiring diagrams

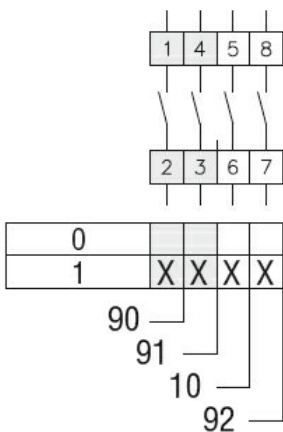

Certifications and compliance

Compliance

CSA C22.2 n° 14
IEC/EN/BS 60947-1
IEC/EN/BS 60947-3
IEC/EN/BS 60947-5-1
IEC/EN/BS 61058-1
UL60947-4-1

Certificates

cULus
EAC

ETIM classification

ETIM 8.0

EC001105 - Off-
load switch