



Contact characteristics

Contact configuration			2 C/O
Rated insulation voltage U_i IEC/EN	V		500
Rated impulse withstand voltage U_{imp}	kV		4
IEC Conventional free air thermal current $I_{th} \leq 40^\circ\text{C}$	A		7
Rated current (I_n)	A		7
Max contrrollable power in			
	AC-1	W	7
Rated operating power AC-1		VA	1750
Rated operating power AC-15	230 VAC	VA	150
Single-phase motor control	230VAC	kW	0.37
Rated operating current DC-1			
	30V	A	12
	110V	A	0.3
	220V	A	0.1
Minimum switching load	V / mA		5 / 100
Contact impedance	m Ω		100
Contact material			Ag/Ni

Operating times

Closing	ms	<25
Opening	ms	<25

Operations

Mechanical life	cycles	20000000
Electrical life AC1	cycles	100000

Coil characteristics

Relay control voltage	V	12VDC
Average coil consumption AC at 20°C	VA	1.7
Average coil consumption DC at 20°C	W	1.1

Operating range

	Closing	% U_n	75...110
	Opening	% U_n	10...30
Maximum cycle frequency		cycles/h	3600

Mechanical features

Max socket terminal tightening torque	Nm	0.6
Socket screw tightening tool (cross / flat blade)		PH1 / 4.5mm
Conductor section		
	AWG/Kcmil	
	min	20
	max	14
	IEC	
	min	mm ² 0.5
	max	mm ² 2.5

Operating position

normal

Any

Fixing

On 35mm DIN rail and with screw

Ambient conditions

Temperature

Operating temperature

min	°C	-40
max	°C	+70

Storage temperature

min	°C	-40
max	°C	+80

Other features

Indication

Yes

Mechanical contact position indicator

Yes

Mechanical test actuator

Yes

Dimensions

HR60 2C... with socket HR6XS21 - HR6XS22

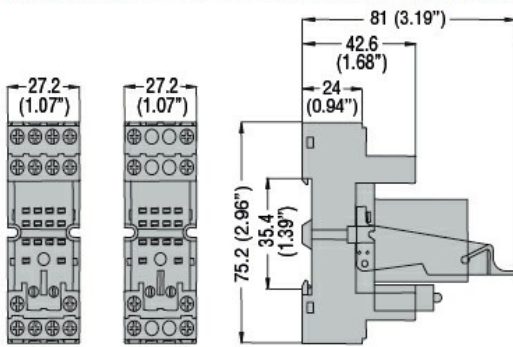

HR60 4C... with socket HR6XS41 - HR6XS42

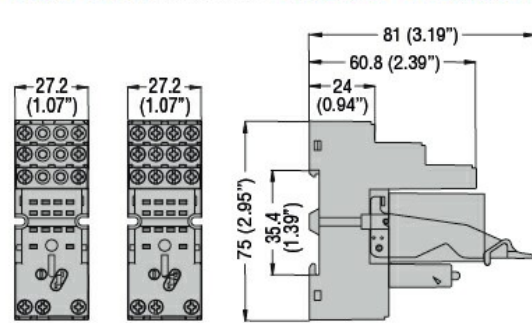

HR60 2C... - HR60 4C... with socket HR6XS21S - HR6XS41S

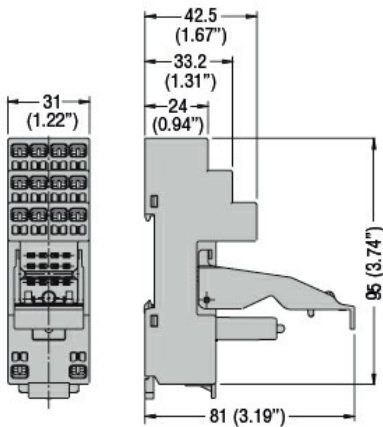

Wiring diagrams

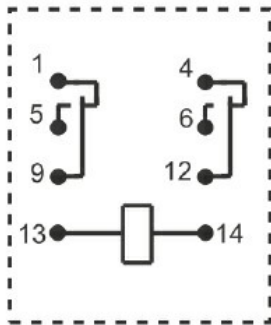
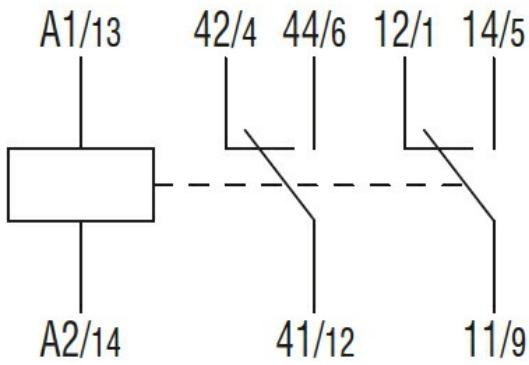

Certifications and compliance

Compliance

IEC/EN 61810

Certificates

CSA

cURus

EAC

VDE

ETIM classification

ETIM 8.0

EC001437 -
Switching relay