



Contact characteristics

Contact configuration			2 C/O
Rated insulation voltage U_i IEC/EN	V		250
Rated impulse withstand voltage U_{imp}	kV		4
IEC Conventional free air thermal current $I_{th} \leq 40^\circ\text{C}$	A		30 NO (3A NC)
Rated current (I_n)	A		30
Single-phase motor control		230VAC	kW 2.2
Contact impedance			m Ω 50
Contact material			Ag/SnO ₂

Operating times

Closing		ms	25
Opening		ms	25

Operations

Mechanical life		cycles	5000000
Electrical life AC1		cycles	100000

Coil characteristics

Relay control voltage		V	230VAC - 50/60Hz
Average coil consumption AC at 20°C		VA	4
Operating range		Closing	% U_n 80...110
		Opening	% U_n 20...55
Maximum cycle frequency		cycles/h	360

UL technical data

UL/CSA General Use		A	30A 277V (NO) 3A 277V (NC)
Yielded mechanical performance for single-phase AC motor		110/120V	HP 1 (NO)
		240V	HP 2.5 (NO)
Full-load current (FLA) at 240V		A	14.5 (NO)
Locked rotor current (LRA) at 240V		A	87 (NO)

Mechanical features

Operating position		normal	Any
Fixing			With screw

Ambient conditions

Temperature			
Operating temperature		min	°C -40
		max	°C +85
Storage temperature		min	°C -40
		max	°C +85

Resistance & Protection

Pollution degree 3

Other features

Indication No

Mechanical contact position indicator No

Mechanical test actuator No

Dimensions

Wiring diagrams

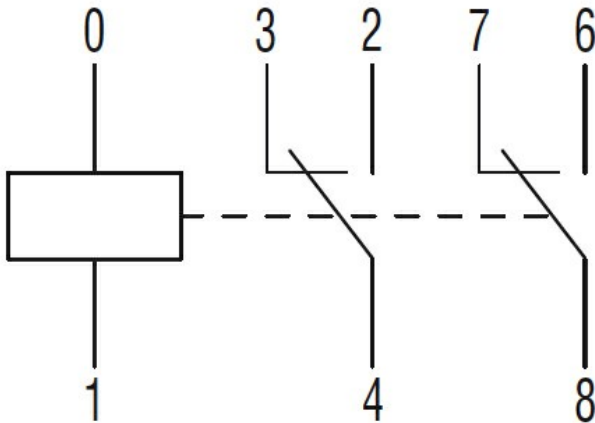

Certifications and compliance

Compliance IEC/EN/BS 61810-1

Certificates

cURus

EAC

TUV (ATEX)

VDE

ETIM classification

ETIM 8.0

EC001437 –
Switching relay